

Ohio Manual of Uniform Traffic Control Devices



2012 Edition

January 13, 2012

Effective April 12, 2012

**Ohio Department of Transportation
Office of Traffic Engineering**

Ohio Manual of Uniform Traffic Control Devices for Streets and Highways

**2012
Edition**



Ohio Manual of Uniform Traffic Control Devices



2012 Edition

January 13, 2012

Effective April 12, 2012

**Ohio Department of Transportation
Office of Traffic Engineering**

**Ohio Department of Transportation
Office of Traffic Engineering
1980 W. Broad St., P.O. Box 899**

Web addresses:

<http://www.dot.state.oh.us/Pages/Home.aspx>

Office of Traffic Engineering:

<http://www.dot.state.oh.us/divisions/Operations/traffic/Pages/OTEHomePage.aspx>

ODOT Publications Design Reference Resource Center:

<http://www.dot.state.oh.us/drrc/Pages/default.aspx>

To request a copy of this manual contact the ODOT Office of Traffic Engineering.

An Equal Opportunity Employer

PREFACE

The “Ohio Manual of Uniform Traffic Control Devices for Streets and Highways” (OMUTCD) has been established to provide a safe, uniform and efficient system of traffic control devices on streets and highways within the State of Ohio. This Manual was prepared pursuant to Section 4511.09 of the Ohio Revised Code (see Appendix B2).

This Manual is in substantial conformance with the 2009 Edition of the “Manual on Uniform Traffic Control Devices for Streets and Highways” (MUTCD) as published by the U.S. Department of Transportation, Federal Highway Administration (FHWA), dated December 2009 and effective January 15, 2010. Most of the text of the OMUTCD is identical to that of the national MUTCD, while some has been modified to meet State laws or to more closely reflect conditions and policies in Ohio. References in this Manual to State Statutes should be understood to refer to the Ohio Revised Code (ORC).

Text in this Manual that is different from that in the MUTCD is shown using Arial font. For example, the text on this page is in Arial font. Text based on the MUTCD (except for Figures and Tables) is shown using Times New Roman font. See the address for AASHTO on the next page for an example of Times New Roman font.

Detail drawings for traffic control signs, along with supplemental details pertaining to standard signs and designable guide signs, can be found in the “Sign Designs and Markings Manual” (SDMM) published by the Ohio Department of Transportation (ODOT). The pavement marking alphabet and symbols are also shown in the SDMM.

Contact information for ordering the OMUTCD is provided on page ii. The OMUTCD, the ODOT “Traffic Engineering Manual” (TEM), and other ODOT publications are also available on-line from the ODOT website at <http://www.dot.state.oh.us/drrc/Pages/default.aspx>.

Improved designs and devices, signs for special applications and variations from standard sign designs and sizes which may be developed after the publication date of this Manual may be used in research or on an experimental basis. However, all such research and/or experimentation with new designs should be coordinated through ODOT (see Section 1A.10).

Addresses for Publications Referenced in the OMUTCD

American Automobile Association (AAA)
1000 AAA Drive
Heathrow, FL 32746
www.aaa.com
800-222-4357

American Association of State Highway and Transportation Officials (AASHTO)
444 North Capitol Street, NW, Suite 249
Washington, DC 20001
www.transportation.org
202-624-5800

American National Standards Institute (ANSI)
1819 L Street, NW, 6th Floor
Washington, DC 20036
www.ansi.org
202-293-8020

American Railway Engineering and Maintenance-of-Way Association (AREMA)
10003 Derekwood Lane, Suite 210
Landover, MD 20706
www.arema.org
301-459-3200

Federal Highway Administration (FHWA)
www.fhwa.dot.gov
For the MUTCD: <http://mutcd.fhwa.dot.gov/>

Federal Highway Administration Report Center
Facsimile number: 814-239-2156
E-mail: [report.center@fhwa.dot.gov/](mailto:report.center@fhwa.dot.gov)

Illuminating Engineering Society (IES)
120 Wall Street, Floor 17
New York, NY 10005
www.iesna.org
212-248-5000

Institute of Makers of Explosives
1120 19th Street, NW, Suite 310
Washington, DC 20036-3605
www.ime.org
202-429-9280

Institute of Transportation Engineers (ITE)
1099 14th Street, NW, Suite 300 West
Washington, DC 20005-3438
www.ite.org
202-289-0222

International Organization for Standardization
1, ch. de la Voie-Creuse
Case Postale 56
CH-1211
Geneva 20, Switzerland
www.iso.ch
011-41-22-749-0111

International Safety Equipment Association (ISEA)
1901 North Moore Street, Suite 808
Arlington, VA 22209
www.safetysafetyequipment.org
703-525-1695

National Committee on Uniform Traffic Laws and Ordinances (NCUTLO)
107 South West Street, Suite 110
Alexandria, VA 22314
www.ncutlo.org
800-807-5290

National Electrical Manufacturers Association (NEMA)
1300 North 17th Street, Suite 1752
Rosslyn, VA 22209
www.nema.org
703-841-3200

Occupational Safety and Health Administration (OSHA)
U.S. Department of Labor
200 Constitution Avenue, NW
Washington, DC 20210
www.osha.gov
800-321-6742

Office of Transportation Operations
Federal Highway Administration
400 Seventh Street, SW
Washington, DC 20590
www.ops.fhwa.dot.gov/siteindex.htm

Direct requests for permission to experiment or interim approval to the MUTCD Team at the following email address: MUTCDofficialrequest@dot.gov.

Transportation Research Board (TRB)
The National Academies
500 Fifth Street, NW
Washington, DC 20001
www.nas.edu/trb
202-334-3072

U.S. Architectural and Transportation Barriers Compliance Board (The U.S. Access Board)
1331 F Street, NW, Suite 1000
Washington, DC 20004-1111
www.access-board.gov
202-272-0080

Acknowledgments

The Ohio Department of Transportation (ODOT) gratefully acknowledges the valuable assistance provided by the Federal Highway Administration (FHWA), the Ohio Section of the Institute of Transportation Engineers (Ohio ITE), the County Engineers Association of Ohio (CEAO), the Ohio Contractor's Association (OCA) and other transportation professionals in the development of this Manual.

Intentionally blank.

**OHIO MANUAL OF UNIFORM TRAFFIC CONTROL DEVICES
TABLE OF CONTENTS**

PREFACE iii

INTRODUCTION..... I-1

PART 1. GENERAL

Chapter 1A. General

Section 1A.01 Purpose of Traffic Control Devices 1

Section 1A.02 Principles of Traffic Control Devices 1

Section 1A.03 Design of Traffic Control Devices 2

Section 1A.04 Placement and Operation of Traffic Control Devices 2

Section 1A.05 Maintenance of Traffic Control Devices 2

Section 1A.06 Uniformity of Traffic Control Devices 2

Section 1A.07 Responsibility for Traffic Control Devices 3

Section 1A.08 Authority for Placement of Traffic Control Devices 3

Section 1A.09 Engineering Study and Engineering Judgment 4

Section 1A.10 Interpretations, Experimentations, Changes, and Interim Approvals 5

Section 1A.11 Relation to Other Publications 8

Section 1A.12 Color Code 11

Section 1A.13 Definitions of Headings, Words, and Phrases in this Manual 12

Section 1A.14 Meanings of Acronyms and Abbreviations in this Manual 27

Section 1A.15 Abbreviations Used on Traffic Control Devices 28

PART 2. SIGNS

Chapter 2A. General

Section 2A.01 Function and Purpose of Signs 33

Section 2A.02 Definitions 33

Section 2A.03 Standardization of Application 33

Section 2A.04 Excessive Use of Signs 34

Section 2A.05 Classification of Signs 34

Section 2A.06 Design of Signs 34

Section 2A.07 Retroreflectivity and Illumination 35

Section 2A.08 Maintaining Minimum Retroreflectivity 37

Section 2A.09 Shapes 39

Section 2A.10 Sign Colors 39

Section 2A.11 Dimensions 39

Section 2A.12 Symbols 42

Section 2A.13 Word Messages 42

Section 2A.14 Sign Borders 43

Section 2A.15 Enhanced Conspicuity for Standard Signs 44

Section 2A.16 Standardization of Location 44

Section 2A.17 Overhead Sign Installations 49

Section 2A.18 Mounting Height 50

Section 2A.19 Lateral Offset 51

Section 2A.20 Orientation 52

Section 2A.21 Posts and Mountings 52

Section 2A.22 Maintenance 52

Section 2A.23 Median Opening Treatments for Divided Highways with Wide Medians 52

Chapter 2B. Regulatory Signs, Barricade, and Gates

Section 2B.01	Application of Regulatory Signs.....	53
Section 2B.02	Design of Regulatory Signs	53
Section 2B.03	Size of Regulatory Signs.....	53
Section 2B.04	Right-of-Way at Intersections.....	61
Section 2B.05	STOP Sign (R1-1) and ALL WAY Plaque (R1-3P).....	63
Section 2B.06	STOP Sign Applications	63
Section 2B.07	Multi-Way Stop Applications	64
Section 2B.08	YIELD Sign (R1-2).....	64
Section 2B.09	YIELD Sign Applications.....	65
Section 2B.10	STOP Sign or YIELD Sign Placement	65
Section 2B.11	Yield Here To Pedestrians Signs (R1-5 Series).....	66
Section 2B.12	In-Street and Overhead Pedestrian Crossing Signs (R1-6, R1-9).....	67
Section 2B.13	Speed Limit Signs (R2-1, R2-H2b)	68
Section 2B.14	Truck Speed Limit Plaque and Signs (R2-2P, R2-H2a)	71
Section 2B.15	Night Speed Limit Plaque (R2-3P).....	71
Section 2B.16	Minimum Speed Limit Plaque (R2-4P)	71
Section 2B.17	Higher Fines Signs and Plaque (R2-6P, R2-10, R2-11)	71
Section 2B.18	Movement Prohibition Signs (R3-1 through R3-4, R3-18, R3-27)	73
Section 2B.19	Intersection Lane Control Signs (R3-5 through R3-8).....	74
Section 2B.20	Mandatory Movement Lane Control Signs (R3-5, R3-5a, R3-7, R3-20)	75
Section 2B.21	Optional Movement Lane Control Sign (R3-6)	76
Section 2B.22	Advance Intersection Lane Control Signs (R3-8 Series).....	77
Section 2B.23	RIGHT (LEFT) LANE MUST EXIT Sign (R3-33)	77
Section 2B.24	Two-Way Left Turn Only Signs (R3-9a, R3-9b).....	77
Section 2B.25	BEGIN and END Plaques (R3-9cP, R3-9dP)	78
Section 2B.26	Reversible Lane Control Signs (R3-9e through R3-9i)	78
Section 2B.27	Jughandle Signs (R3-23, R3-24, R3-25, and R3-26 Series)	81
Section 2B.28	DO NOT PASS Sign (R4-1).....	85
Section 2B.29	PASS WITH CARE Sign (R4-2).....	85
Section 2B.30	SLOWER TRAFFIC KEEP RIGHT Sign (R4-3).....	85
Section 2B.31	TRUCKS USE RIGHT LANE Sign (R4-5)	86
Section 2B.32	Keep Right and Keep Left Signs (R4-H3a, R4-7, R4-8).....	87
Section 2B.33	STAY IN LANE Sign (R4-9)	87
Section 2B.34	RUNAWAY VEHICLES ONLY Sign (R4-10)	88
Section 2B.35	Slow Vehicle Turn-Out Signs (R4-12, R4-13, R4-14)	88
Section 2B.36	DO NOT DRIVE ON SHOULDER Sign (R4-17) and DO NOT PASS ON SHOULDER Sign (R4-18)	88
Section 2B.37	DO NOT ENTER Sign (R5-1).....	88
Section 2B.38	WRONG WAY Sign (R5-1a).....	89
Section 2B.39	Selective Exclusion Signs	90
Section 2B.40	ONE WAY Signs (R6-1, R6-2)	91
Section 2B.41	Wrong-Way Traffic Control at Interchange Ramps	93
Section 2B.42	Divided Highway Crossing Signs (R6-3, R6-3a).....	96
Section 2B.43	Roundabout Directional Arrow Signs (R6-4, R6-4a, R6-4b)	98
Section 2B.44	Roundabout Circulation Plaque (R6-5P)	102
Section 2B.45	Examples of Roundabout Signing	102
Section 2B.46	Parking, Standing, and Stopping Signs (R7 and R8 Series)	102
Section 2B.47	Design of Parking, Standing, and Stopping Signs	104
Section 2B.48	Placement of Parking, Stopping, and Standing Signs.....	106
Section 2B.49	Emergency Restriction Signs (R8-4, R8-7, R8-8)	107
Section 2B.50	WALK ON LEFT FACING TRAFFIC and No Hitchhiking Signs (R9-1, R9-4, R9-4a) ...	107

Section 2B.51 Pedestrian Crossing Signs (R9-2, R9-3) 107

Section 2B.52 Traffic Signal Pedestrian and Bicycle Actuation Signs (R10-1 through R10-4,
and R10-24 through R10-26) 109

Section 2B.53 Traffic Signal Signs (R10-5 through R10-30) 110

Section 2B.54 No Turn on Red Signs (R10-11 Series, R10-17a, and R10-30)..... 112

Section 2B.55 Photo Enforced Signs and Plaques (R10-18, R10-19P, R10-19aP)..... 112

Section 2B.56 Ramp Metering Signs (R10-28, R10-29) 113

Section 2B.57 KEEP OFF MEDIAN Sign (R11-1) 113

Section 2B.58 ROAD CLOSED Sign (R11-2) and LOCAL TRAFFIC ONLY Signs (R11-3 Series,
R11-4) 113

Section 2B.59 Weight Limit Signs (R12-1 through R12-H5) 113

Section 2B.60 Weigh Station Signs (R13 Series)..... 115

Section 2B.61 TRUCK ROUTE Sign (R14-1)..... 115

Section 2B.62 Hazardous Material Signs (R14-2, R14-3)..... 115

Section 2B.63 National Network Signs (R14-4, R14-5) 115

Section 2B.64 Headlight Use Signs (R16-5 through R16-11)..... 115

Section 2B.65 FENDER BENDER Sign (R16-4) 116

Section 2B.66 Seat Belt Sign (R16-H1)..... 116

Section 2B.67 Barricades 116

Section 2B.68 Gates 117

Chapter 2C. Warning Signs and Object Markers

Section 2C.01 Function of Warning Signs 119

Section 2C.02 Application of Warning Signs..... 119

Section 2C.03 Design of Warning Signs 119

Section 2C.04 Size of Warning Signs..... 125

Section 2C.05 Placement of Warning Signs..... 125

Section 2C.06 Horizontal Alignment Warning Signs..... 126

Section 2C.07 Horizontal Alignment Signs (W1-1 through W1-5, W1-11, W1-15) 127

Section 2C.08 Advisory Speed Plaque (W13-1P) 128

Section 2C.09 Chevron Alignment Sign (W1-8)..... 130

Section 2C.10 Combination Horizontal Alignment/Advisory Speed Signs (W1-1a, W1-2a)..... 131

Section 2C.11 Combination Horizontal Alignment/Intersection Signs (W1-10 Series) 131

Section 2C.12 One-Direction Large Arrow Sign (W1-6)..... 131

Section 2C.13 Truck Rollover Warning Sign (W1-13) 132

Section 2C.14 Advisory Exit and Ramp Speed Signs (W13-2, W13-3) 132

Section 2C.15 Combination Horizontal Alignment/Advisory Exit and Ramp Speed Signs
(W13-6, W13-7)..... 133

Section 2C.16 Hill Signs (W7-1, W7-1a)..... 133

Section 2C.17 Truck Escape Ramp Signs (W7-4 Series)..... 135

Section 2C.18 HILL BLOCKS VIEW Sign (W7-6) 135

Section 2C.19 ROAD NARROWS Sign (W5-1) 136

Section 2C.20 NARROW BRIDGE Sign (W5-2)..... 137

Section 2C.21 ONE LANE BRIDGE Sign (W5-3)..... 137

Section 2C.22 Divided Highway Sign (W6-1) 137

Section 2C.23 Divided Highway Ends Sign (W6-2)..... 137

Section 2C.24 Freeway or Expressway Ends Signs (W19 Series) 137

Section 2C.25 Double Arrow Sign (W12-1) 138

Section 2C.26 DEAD END/NO OUTLET Signs (W14-1, W14-1a, W14-2, W14-2a)..... 138

Section 2C.27 Low Clearance Signs (W12-2, W12-2a)..... 138

Section 2C.28 BUMP and DIP Signs (W8-1, W8-2) 140

Section 2C.29 SPEED HUMP Sign (W17-1)..... 140

Section 2C.30 PAVEMENT ENDS Sign (W8-3) 140

Section 2C.31	Shoulder Signs (W8-4, W8-9, W8-17, W8-23, W8-25)	140
Section 2C.32	Surface Condition Signs (W8-5, W8-7, W8-8, W8-11, W8-13, W8-14)	141
Section 2C.33	Warning Signs and Plaques for Motorcyclists (W8-15, W8-15P, W8-16)	141
Section 2C.34	NO CENTER LINE and NO EDGE LINE Signs (W8-12, W8-H12a)	142
Section 2C.35	Weather Condition Signs (W8-18, W8-19, W8-21, W8-22)	142
Section 2C.36	Advance Traffic Control Signs (W3-1, W3-2, W3-3, W3-4)	142
Section 2C.37	Advance Ramp Control Signal Signs (W3-7, W3-8)	143
Section 2C.38	Reduced Speed Limit Ahead Signs (W3-5, W3-5a)	143
Section 2C.39	DRAW BRIDGE Sign (W3-6)	144
Section 2C.40	Merge Signs (W4-1, W4-5)	144
Section 2C.41	Added Lane Signs (W4-3, W4-6)	145
Section 2C.42	Lane Ends Signs (W4-2, W9-1, W9-2)	145
Section 2C.43	RIGHT (LEFT) LANE EXIT ONLY AHEAD Sign (W9-7)	146
Section 2C.44	Two-Way Traffic Sign (W6-3)	146
Section 2C.45	NO PASSING ZONE Sign (W14-3)	146
Section 2C.46	Intersection Warning Signs (W2-1 through W2-8)	146
Section 2C.47	Two-Direction Large Arrow Sign (W1-7)	147
Section 2C.48	Traffic Signal Signs (W25-1, W25-2)	148
Section 2C.49	Vehicular Traffic Warning Signs (W8-6, W11-1, W11-5, W11-5a, W11-8, W11-10, W11-11, W11-12P, W11-14, W11-15, W11-15a)	148
Section 2C.50	Non-Vehicular Warning Signs (W11-2, W11-3, W11-4, W11-6, W11-7, W11-9, and W11-16 through W11-22)	149
Section 2C.51	Playground Sign (W15-1)	151
Section 2C.52	NEW TRAFFIC PATTERN AHEAD Sign (W23-2)	151
Section 2C.53	Use of Supplemental Warning Plaques	151
Section 2C.54	Design of Supplemental Warning Plaques	151
Section 2C.55	Distance Plaques (W16-2 Series, W16-3 Series, W16-4P, W7-3aP)	151
Section 2C.56	Supplemental Arrow Plaques (W16-5P, W16-6P)	151
Section 2C.57	Hill-Related Plaques (W7-2 Series, W7-3 Series)	152
Section 2C.58	Advance Street Name Plaques (W16-8P, W16-8aP)	152
Section 2C.59	CROSS TRAFFIC DOES NOT STOP Plaque (W4-4P)	153
Section 2C.60	SHARE THE ROAD Plaque (W16-1P)	153
Section 2C.61	PHOTO ENFORCED Plaque (W16-10P)	153
Section 2C.62	NEW Plaque (W16-15P)	153
Section 2C.63	Object Marker Design and Placement Height	154
Section 2C.64	Object Markers for Obstructions Within the Roadway	155
Section 2C.65	Object Markers for Obstructions Adjacent to the Roadway	155
Section 2C.66	Object Markers for Ends of Roadways	156
 Chapter 2D. Guide Signs—Conventional Roads		
Section 2D.01	Scope of Conventional Road Guide Sign Standards	157
Section 2D.02	Application	157
Section 2D.03	Color, Retroreflection, and Illumination	157
Section 2D.04	Size of Signs	157
Section 2D.05	Lettering Style	158
Section 2D.06	Size of Lettering	160
Section 2D.07	Amount of Legend	160
Section 2D.08	Arrows	161
Section 2D.09	Numbered Highway Systems	163
Section 2D.10	Route Signs and Auxiliary Signs	163
Section 2D.11	Design of Route Signs	164
Section 2D.12	Design of Route Sign Auxiliaries	165
Section 2D.13	Junction Auxiliary Sign (M2-1)	166

Section 2D.14	Combination Junction Sign (M2-2)	166
Section 2D.15	Cardinal Direction Auxiliary Signs (M3-1 through M3-4)	166
Section 2D.16	Auxiliary Signs for Alternative Routes (M4 Series)	167
Section 2D.17	ALTERNATE Auxiliary Signs (M4-1, M4-1a)	167
Section 2D.18	BY-PASS Auxiliary Sign (M4-2)	167
Section 2D.19	BUSINESS Auxiliary Sign (M4-3)	167
Section 2D.20	TRUCK Auxiliary Sign (M4-4)	168
Section 2D.21	TO Auxiliary Sign (M4-5)	168
Section 2D.22	END Auxiliary Sign (M4-6)	168
Section 2D.23	BEGIN Auxiliary Sign (M4-14)	168
Section 2D.24	TEMPORARY Auxiliary Signs (M4-7, M4-7a)	168
Section 2D.25	Temporary Detour and Auxiliary Signs	169
Section 2D.26	Advance Turn Arrow Auxiliary Signs (M5-1, M5-2, M5-3)	169
Section 2D.27	Lane Designation Auxiliary Signs (M5-4, M5-5, M5-6)	169
Section 2D.28	Directional Arrow Auxiliary Signs (M6 Series)	170
Section 2D.29	Route Sign Assemblies	170
Section 2D.30	Junction Assembly	170
Section 2D.31	Advance Route Turn Assembly	175
Section 2D.32	Directional Assembly	175
Section 2D.33	Combination Lane-Use/Destination Overhead Guide Sign (D15-1)	176
Section 2D.34	Confirming or Reassurance Assemblies	177
Section 2D.35	Trailblazer Assembly	177
Section 2D.36	Destination and Distance Signs	178
Section 2D.37	Destination Signs (D1 Series)	178
Section 2D.38	Destination Signs at Circular Intersections	179
Section 2D.39	Destination Signs at Jughandles	183
Section 2D.40	Location of Destination Signs	183
Section 2D.41	Distance Signs (D2 Series)	183
Section 2D.42	Location of Distance Signs	184
Section 2D.43	Street Name Signs (D3-1 or D3-1a)	184
Section 2D.44	Advance Street Name Signs (D3-2)	186
Section 2D.45	Signing on Conventional Roads on Approaches to Interchanges	187
Section 2D.46	Freeway Entrance Signs (D13-3, D13-3a)	194
Section 2D.47	Parking Area Guide Sign (D4-1)	194
Section 2D.48	PARK - RIDE Sign (D4-2)	194
Section 2D.49	Weigh Station Signing (D8 Series)	195
Section 2D.50	Community Wayfinding Signs	195
Section 2D.51	Truck, Passing, or Climbing Lane Signs (D17-1, D17-2)	202
Section 2D.52	Slow Vehicle Turn-Out Sign (D17-7)	202
Section 2D.53	Signing of Named Highways	202
Section 2D.54	Crossover Signs (D13-1, D13-2)	203
Section 2D.55	National Scenic Byways Signs (D6-4, D6-4a)	204
Section 2D.56	Ohio Byways Signs (M8-H3, M8-H3P)	205
Chapter 2E. Guide Signs—Freeways and Expressways		
Section 2E.01	Scope of Freeway and Expressway Guide Sign Standards	207
Section 2E.02	Freeway and Expressway Signing Principles	207
Section 2E.03	Guide Sign Classification	207
Section 2E.04	General	208
Section 2E.05	Color of Guide Signs	208
Section 2E.06	Retroreflection or Illumination	208
Section 2E.07	Characteristics of Urban Signing	208
Section 2E.08	Characteristics of Rural Signing	209

Section 2E.09	Signing of Named Highways	209
Section 2E.10	Amount of Legend on Guide Signs.....	209
Section 2E.11	Number of Signs at an Overhead Installation and Sign Spreading	210
Section 2E.12	Pull-Through Signs	211
Section 2E.13	Designation of Destinations	211
Section 2E.14	Size and Style of Letters and Signs.....	211
Section 2E.15	Interline and Edge Spacing	212
Section 2E.16	Sign Borders	212
Section 2E.17	Abbreviations.....	214
Section 2E.18	Symbols	215
Section 2E.19	Arrows for Interchange Guide Signs	215
Section 2E.20	Signing for Option Lanes at Splits and Multi-Lane Exits.....	217
Section 2E.21	Design of Overhead Arrow-per-Lane Guide Signs for Option Lanes	217
Section 2E.22	Design of Freeway and Expressway Diagrammatic Guide Signs for Option Lanes	223
Section 2E.23	Signing for Intermediate and Minor Interchange Multi-Lane Exits with an Option Lane ..	227
Section 2E.24	Signing for Interchange Lane Drops.....	230
Section 2E.25	Overhead Sign Installations	234
Section 2E.26	Lateral Offset	234
Section 2E.27	Route Signs and Trailblazer Assemblies	235
Section 2E.28	Eisenhower Interstate System Signs (M1-10).....	236
Section 2E.29	Signs for Intersections at Grade.....	236
Section 2E.29.1	Expressway Street Name Sign (D3-H3 or D3-H3a).....	237
Section 2E.29.2	Expressway At-Grade Intersection Advance Street Name Sign (D3-H4) ..	237
Section 2E.30	Interchange Guide Signs	237
Section 2E.31	Interchange Exit Numbering (E1-H5P)	237
Section 2E.32	Interchange Classification.....	242
Section 2E.33	Advance Guide Signs.....	242
Section 2E.34	Next Exit Plaques (E2-H1P, E2-H1aP).....	244
Section 2E.35	Other Supplemental Guide Signs.....	244
Section 2E.36	Exit Direction Signs.....	246
Section 2E.37	Exit Gore Signs (E5-H1 Series).....	248
Section 2E.38	Post-Interchange Signs.....	249
Section 2E.39	Post-Interchange Distance Signs (E7-H1).....	249
Section 2E.40	Interchange Sequence Signs (E7-H2).....	250
Section 2E.41	Community Interchanges Identification Signs (E7-H3).....	252
Section 2E.42	NEXT XX EXITS Sign (E7-H4)	252
Section 2E.43	Signing by Type of Interchange.....	252
Section 2E.44	Freeway-to-Freeway Interchange	253
Section 2E.45	Cloverleaf Interchange.....	253
Section 2E.46	Cloverleaf Interchange with Collector-Distributor Roadways	259
Section 2E.47	Partial Cloverleaf Interchange	259
Section 2E.48	Diamond Interchange.....	259
Section 2E.49	Diamond Interchange in Urban Area.....	261
Section 2E.50	Closely-Spaced Interchanges	261
Section 2E.51	Minor Interchange.....	262
Section 2E.52	Signing on Conventional Road Approaches and Connecting Roadways	263
Section 2E.53	Wrong-Way Traffic Control at Interchange Ramps	264
Section 2E.54	Weigh Station Signing (D8-H2).....	264
 Chapter 2F. Toll Road Signs		
Section 2F.01	Scope.....	265
Section 2F.02	Sizes of Toll Road Signs.....	265
Section 2F.03	Use of Purple Backgrounds and Underlay Panels with Electronic Toll Collection	

	(ETC) Account Pictographs	265
Section 2F.04	Size of ETC Pictographs	266
Section 2F.05	Regulatory Signs for Toll Plazas.....	267
Section 2F.06	Pay Toll Advance Warning Sign (W9-6).....	269
Section 2F.07	Pay Toll Advance Warning Plaque (W9-6P)	269
Section 2F.08	Stop Ahead Pay Toll Warning Sign (W9-6a)	270
Section 2F.09	Stop Ahead Pay Toll Warning Plaque (W9-6aP).....	271
Section 2F.10	LAST EXIT BEFORE TOLL Warning Plaque (W16-16P)	271
Section 2F.11	TOLL Auxiliary Sign (M4-15)	272
Section 2F.12	Electronic Toll Collection (ETC) Account-Only Auxiliary Signs (M4-16 and M4-20).....	272
Section 2F.13	Toll Facility and Toll Plaza Guide Signs – General.....	272
Section 2F.14	Advance Signs for Conventional Toll Plazas.....	277
Section 2F.15	Advance Signs for Toll Plazas on Diverging Alignments from Open-Road ETC Account-Only Lanes	278
Section 2F.16	Toll Plaza Canopy Signs	279
Section 2F.17	Guide Signs for Entrances to ETC Account-Only Facilities.....	279
Section 2F.18	ETC Program Information Signs	282
 Chapter 2G. Preferential and Manage Lane Signs		
Section 2G.01	Scope.....	283
Section 2G.02	Sizes of Preferential and Managed Lane Signs.....	283
Section 2G.03	Regulatory Signs for Preferential Lanes – General.....	283
Section 2G.04	Preferential Lane Vehicle Occupancy Definition Regulatory Signs (R3-10 Series and R3-13 Series)	289
Section 2G.05	Preferential Lane Periods of Operation Regulatory Signs (R3-11 Series and R3-14 Series)	290
Section 2G.06	Preferential Lane Advance Regulatory Signs (R3-12, R3-12e, R3-12f, R3-15, R3-15a, R3-15d).....	294
Section 2G.07	Preferential Lane Ends Regulatory Signs (R3-12a, R3-12b, R3-12c, R3-12d, R3-12g, R3- 12h, R3-15b, R3-15c, R3-15e).....	295
Section 2G.08	Warning Signs on Median Barriers for Preferential Lanes	296
Section 2G.09	High-Occupancy Vehicle (HOV) Plaque (W16-11P)	296
Section 2G.10	Preferential Lane Guide Signs – General.....	296
Section 2G.11	Guide Signs for Initial Entry Points to Preferential Lanes.....	300
Section 2G.12	Guide Signs for Intermediate Entry Points to Preferential Lanes	302
Section 2G.13	Guide Signs for Egress from Preferential Lanes to General-Purpose Lanes	302
Section 2G.14	Guide Signs for Direct Entrances to Preferential Lanes from Another Highway	305
Section 2G.15	Guide Signs for Direct Exits from Preferential Lanes to Another Highway.....	305
Section 2G.16	Signs for Priced Managed Lanes – General.....	308
Section 2G.17	Regulatory Signs for Priced Managed Lanes.....	311
Section 2G.18	Guide Signs for Priced Managed Lanes.....	314
 Chapter 2H. General Information Signs		
Section 2H.01	Sizes of General Information Signs	325
Section 2H.02	General Information Signs (I Series)	325
Section 2H.03	Traffic Signal Speed Sign (I1-1)	328
Section 2H.04	Miscellaneous Information Signs.....	328
Section 2H.05	Reference Location Signs (D10-1 through D10-3) and Intermediate Reference Location Signs (D10-1a through D10-3a).....	329
Section 2H.06	Enhanced Reference Location Signs (D10-4, D10-5, D10-H5a).....	330
Section 2H.07	Auto Tour Route Signs	331
Section 2H.08	Acknowledgment Signs	332
 Chapter 2I. General Service Signs		

Section 2I.01	Sizes of General Service Signs	335
Section 2I.02	General Service Signs for Conventional Roads	338
Section 2I.03	General Service Signs for Freeways and Expressways.....	339
Section 2I.04	Interstate Oasis Signing	342
Section 2I.05	Rest Area and Other Roadside Area Signs	342
Section 2I.06	Brake Check Area Signs (D5-13, D5-14)	343
Section 2I.07	Chain-Up Area Signs (D5-15, D5-16)	344
Section 2I.08	Tourist Information and Welcome Center Signs	344
Section 2I.09	Radio Information Signing	345
Section 2I.10	TRAVEL INFO CALL 511 Signs (D12-5, D12-5a)	347
Section 2I.11	Carpool and Ridesharing Signing	347

Chapter 2J. Specific Service Signs

Section 2J.01	State Policy	349
Section 2J.02	Application.....	349
Section 2J.03	Logos and Logo Sign Panels.....	352
Section 2J.04	Number and Size of Signs and Logo Sign Panels.....	353
Section 2J.05	Size of Lettering.....	354
Section 2J.06	Signs at Interchanges	354
Section 2J.07	Single-Exit Interchanges	354
Section 2J.08	Double-Exit Interchanges	355
Section 2J.09	Specific Service Trailblazer Signs	355
Section 2J.10	Signs at Intersections	356

Chapter 2K. Tourist-Oriented Directional Signs

Section 2K.01	State Policy	357
Section 2K.02	Application.....	357
Section 2K.03	Style and Size of Lettering.....	358
Section 2K.04	Arrangement and Size of Signs.....	358
Section 2K.05	Advance Signs	361
Section 2K.06	Sign Locations	361

Chapter 2L. Changeable Message Signs

Section 2L.01	Description of Changeable Message Signs.....	363
Section 2L.02	Applications of Changeable Message Signs	363
Section 2L.03	Legibility and Visibility of Changeable Message Signs	364
Section 2L.04	Design Characteristics of Changeable Message Signs	364
Section 2L.05	Message Length and Units of Information	366
Section 2L.06	Installation of Permanent Changeable Message Signs	367

Chapter 2M. Recreational and Cultural Interest Area Signs

Section 2M.01	Scope.....	369
Section 2M.02	Application of Recreational and Cultural Interest Area Signs.....	369
Section 2M.03	Regulatory and Warning Signs	369
Section 2M.04	General Design Requirements for Recreational and Cultural Interest Area Symbol Signs	369
Section 2M.05	Symbol Sign Sizes	371
Section 2M.06	Use of Educational Plaques	371
Section 2M.07	Use of Prohibitive Circle and Diagonal Slash for Non-Road Applications.....	371
Section 2M.08	Placement of Recreational and Cultural Interest Area Symbol Signs.....	371
Section 2M.09	Destination Guide Signs	374
Section 2M.10	Memorial or Dedication Signing	380

Chapter 2N. Emergency Management Signing

Section 2N.01	Emergency Management	383
---------------	----------------------------	-----

Section 2N.02 Design of Emergency Management Signs 383
 Section 2N.03 Evacuation Route Signs (EM-1) 383
 Section 2N.04 AREA CLOSED Sign (EM-2)..... 385
 Section 2N.05 TRAFFIC CONTROL POINT Sign (EM-3) 385
 Section 2N.06 MAINTAIN TOP SAFE SPEED Sign (EM-4)..... 386
 Section 2N.07 ROAD (AREA) USE PERMIT REQUIRED FOR THRU TRAFFIC Sign (EM-5) 386
 Section 2N.08 Emergency Aid Center Signs (EM-6 Series) 386
 Section 2N.09 Shelter Directional Signs (EM-7 Series)..... 387

PART 3. MARKINGS

Chapter 3A. General

Section 3A.01 Functions and Limitations..... 389
 Section 3A.02 Standardization of Application 389
 Section 3A.03 Maintaining Minimum Pavement Marking Retroreflectivity 389
 Section 3A.04 Materials 389
 Section 3A.05 Colors..... 390
 Section 3A.06 Functions, Widths, and Patterns of Longitudinal Pavement Markings 390

Chapter 3B. Pavement and Curb Markings

Section 3B.01 Yellow Center Line Pavement Markings and Warrants..... 393
 Section 3B.02 No-Passing Zone Pavement Markings and Warrants..... 396
 Section 3B.03 Other Yellow Longitudinal Pavement Markings 399
 Section 3B.04 White Lane Line Pavement Markings and Warrants 399
 Section 3B.05 Other White Longitudinal Pavement Markings 415
 Section 3B.06 Edge Line Pavement Markings 416
 Section 3B.07 Warrants for Use of Edge Lines..... 416
 Section 3B.08 Extensions Through Intersections or Interchanges 417
 Section 3B.09 Lane-Reduction Transition Markings 417
 Section 3B.10 Approach Markings for Obstructions..... 421
 Section 3B.11 Raised Pavement Markers – General 424
 Section 3B.12 Raised Pavement Markers as Vehicle Positioning Guides with Other Longitudinal
 Markings 425
 Section 3B.13 Raised Pavement Markers Supplementing Other Markings 425
 Section 3B.14 Raised Pavement Markers Substituting for Pavement Markings..... 426
 Section 3B.15 Transverse Markings..... 427
 Section 3B.16 Stop and Yield Lines..... 427
 Section 3B.17 Do Not Block Intersection Markings 429
 Section 3B.18 Crosswalk Markings 430
 Section 3B.19 Parking Space Markings 432
 Section 3B.20 Pavement Word, Symbol, and Arrow Markings..... 432
 Section 3B.21 Speed Measurement Markings..... 440
 Section 3B.22 Speed Reduction Markings 440
 Section 3B.23 Curb Markings 441
 Section 3B.24 Chevron and Diagonal Crosshatch Markings 442
 Section 3B.25 Speed Hump Markings..... 443
 Section 3B.26 Advance Speed Hump Markings 444

Chapter 3C. Roundabout Markings

Section 3C.01 General..... 447
 Section 3C.02 White Lane Line Pavement Markings for Roundabouts..... 461
 Section 3C.03 Edge Line Pavement Markings for Roundabout Circulatory Roadways 461
 Section 3C.04 Yield Lines for Roundabouts 461
 Section 3C.05 Crosswalk Markings at Roundabouts..... 461

Section 3C.06	Word, Symbol, and Arrow Pavement Markings for Roundabouts	461
Section 3C.07	Markings for Other Circular Intersections	462
Chapter 3D. Markings for Preferential Lanes		
Section 3D.01	Preferential Lane Word and Symbol Markings	463
Section 3D.02	Preferential Lane Longitudinal Markings for Motor Vehicles	464
Chapter 3E. Markings for Toll Plazas		
Section 3E.01	Markings for Toll Plazas	473
Chapter 3F. Delineators		
Section 3F.01	Delineators	475
Section 3F.02	Delineator Design	475
Section 3F.03	Delineator Application	475
Section 3F.04	Delineator Placement and Spacing	477
Chapter 3G. Colored Pavements		
Section 3G.01	General	479
Chapter 3H. Channelizing Devices Used for Emphasis of Pavement Marking Patterns		
Section 3H.01	Channelizing Devices	481
Chapter 3I. Islands		
Section 3I.01	General	483
Section 3I.02	Approach-End Treatment	483
Section 3I.03	Island Marking Application	483
Section 3I.04	Island Marking Colors	483
Section 3I.05	Island Delineation	484
Section 3I.06	Pedestrian Islands and Medians	484
Chapter 3J. Rumble Strip Markings		
Section 3J.01	Longitudinal Rumble Strip Markings	485
Section 3J.02	Transverse Rumble Strip Markings	485
PART 4. HIGHWAY TRAFFIC SIGNALS		
Chapter 4A. General		
Section 4A.01	Types	487
Section 4A.02	Definitions Relating to Highway Traffic Signals	487
Chapter 4B. Traffic Control Signals—General		
Section 4B.01	General	489
Section 4B.02	Basis of Installation or Removal of Traffic Control Signals	489
Section 4B.03	Advantages and Disadvantages of Traffic Control Signals	489
Section 4B.04	Alternatives to Traffic Control Signals	490
Section 4B.05	Adequate Roadway Capacity	491
Section 4B.06	Traffic Signals on State Highway Extensions in Villages	491
Chapter 4C. Traffic Control Signal Needs Studies		
Section 4C.01	Studies and Factors for Justifying Traffic Control Signals	493
Section 4C.02	Warrant 1, Eight-Hour Vehicular Volume	495
Section 4C.03	Warrant 2, Four-Hour Vehicular Volume	496
Section 4C.04	Warrant 3, Peak Hour	499
Section 4C.05	Warrant 4, Pedestrian Volume	499
Section 4C.06	Warrant 5, School Crossing	500

Section 4C.07 Warrant 6, Coordinated Signal System..... 503
 Section 4C.08 Warrant 7, Crash Experience 503
 Section 4C.09 Warrant 8, Roadway Network 504
 Section 4C.10 Warrant 9, Intersection Near a Grade Crossing 504

Chapter 4D. Traffic Control Signal Features

Section 4D.01 General..... 509
 Section 4D.02 Responsibility for Operation and Maintenance..... 510
 Section 4D.03 Provisions for Pedestrians 510
 Section 4D.04 Meaning of Vehicular Signal Indications 511
 Section 4D.05 Application of Steady Signal Indications..... 513
 Section 4D.06 Signal Indications – Design, Illumination, Color, and Shape 517
 Section 4D.07 Size of Vehicular Signal Indications..... 517
 Section 4D.08 Positions of Signal Indications Within a Signal Face – General..... 518
 Section 4D.09 Positions of Signal Indications Within a Vertical Signal Face 519
 Section 4D.10 Positions of Signal Indications Within a Horizontal Signal Face 520
 Section 4D.11 Number of Signal Faces on an Approach 521
 Section 4D.12 Visibility, Aiming, and Shielding of Signal Faces..... 523
 Section 4D.13 Lateral Positioning of Signal Faces 525
 Section 4D.14 Longitudinal Positioning of Signal Faces 526
 Section 4D.15 Mounting Height of Signal Faces 527
 Section 4D.16 Lateral Offset (Clearance) of Signal Faces 528
 Section 4D.17 Signal Indications for Left-Turn Movements – General..... 528
 Section 4D.18 Signal Indications for Permissive Only Mode Left-Turn Movements..... 530
 Section 4D.19 Signal Indications for Protected Only Mode Left-Turn Movements 531
 Section 4D.20 Signal Indications for Protected/Permissive Mode Left-Turn Movements..... 532
 Section 4D.21 Signal Indications for Right-Turn Movements – General..... 536
 Section 4D.22 Signal Indications for Permissive Only Mode Right-Turn Movements 537
 Section 4D.23 Signal Indications for Protected Only Mode Right-Turn Movements 540
 Section 4D.24 Signal Indications for Protected/Permissive Mode Right-Turn Movements 542
 Section 4D.25 Signal Indications for Approaches With Shared Left-Turn/Right-Turn Lanes and No Through Movement..... 544
 Section 4D.26 Yellow Change and Red Clearance Intervals..... 549
 Section 4D.27 Preemption and Priority Control of Traffic Control Signals..... 550
 Section 4D.28 Flashing Operation of Traffic Control Signals – General 552
 Section 4D.29 Flashing Operation – Transition Into Flashing Mode 552
 Section 4D.30 Flashing Operation – Signal Indications During Flashing Mode..... 552
 Section 4D.31 Flashing Operation – Transition Out of Flashing Mode 553
 Section 4D.32 Temporary and Portable Traffic Control Signals..... 554
 Section 4D.33 Lateral Offset of Signal Supports and Cabinets 554
 Section 4D.34 Use of Signs at Signalized Locations..... 555
 Section 4D.35 Use of Pavement Markings at Signalized Locations..... 555

Chapter 4E. Pedestrian Control Features

Section 4E.01 Pedestrian Signal Heads..... 557
 Section 4E.02 Meaning of Pedestrian Signal Head Indications 557
 Section 4E.03 Application of Pedestrian Signal Heads..... 557
 Section 4E.04 Size, Design, and Illumination of Pedestrian Signal Head Indications..... 558
 Section 4E.05 Location and Height of Pedestrian Signal Heads..... 559
 Section 4E.06 Pedestrian Intervals and Signal Phases 559
 Section 4E.07 Countdown Pedestrian Signals..... 562
 Section 4E.08 Pedestrian Detectors..... 563
 Section 4E.09 Accessible Pedestrian Signals and Detectors – General 567

Section 4E.10	Accessible Pedestrian Signals and Detectors – Location.....	568
Section 4E.11	Accessible Pedestrian Signals and Detectors – Walk Indications	568
Section 4E.12	Accessible Pedestrian Signals and Detectors – Tactile Arrows and Locator Tones	570
Section 4E.13	Accessible Pedestrian Signals and Detectors – Extended Pushbutton Press Features	571
Chapter 4F Pedestrian Hybrid Beacons		
Section 4F.01	Application of Pedestrian Hybrid Beacons	573
Section 4F.02	Design of Pedestrian Hybrid Beacons	573
Section 4F.03	Operation of Pedestrian Hybrid Beacons.....	576
Chapter 4G. Traffic Control Signals and Hybrid Beacons for Emergency Vehicle Access		
Section 4G.01	Application of Emergency-Vehicle Traffic Control Signals and Hybrid Beacons	577
Section 4G.02	Design of Emergency-Vehicle Traffic Control Signals	577
Section 4G.03	Operation of Emergency-Vehicle Traffic Control Signals	578
Section 4G.04	Emergency-Vehicle Hybrid Beacons.....	578
Chapter 4H. Traffic Control Signals for One-Lane, Two-Way Facilities		
Section 4H.01	Application of Traffic Control Signals for One-Lane, Two-Way Facilities	581
Section 4H.02	Design of Traffic Control Signals for One-Lane, Two-Way Facilities	581
Section 4H.03	Operation of Traffic Control Signals for One-Lane, Two-Way Facilities.....	581
Chapter 4I. Traffic Control Signals for Freeway Entrance Ramps		
Section 4I.01	Application of Freeway Entrance Ramp Control Signals	583
Section 4I.02	Design of Freeway Entrance Ramp Control Signals	583
Section 4I.03	Operation of Freeway Entrance Ramp Control Signals.....	584
Chapter 4J. Traffic Control for Movable Bridges		
Section 4J.01	Application of Traffic Control for Movable Bridges.....	585
Section 4J.02	Design and Location of Movable Bridge Signals and Gates	585
Section 4J.03	Operation of Movable Bridge Signals and Gates.....	587
Chapter 4K. Highway Traffic Signals at Toll Plazas		
Section 4K.01	Traffic Signals at Toll Plazas.....	589
Section 4K.02	Lane-Use Control Signals at or Near Toll Plazas	589
Section 4K.03	Warning Beacons at Toll Plazas	589
Chapter 4L. Flashing Beacons		
Section 4L.01	General Design and Operation of Flashing Beacons	591
Section 4L.02	Intersection Control Beacon	591
Section 4L.03	Warning Beacon	592
Section 4L.04	Speed Limit Sign Beacon.....	592
Section 4L.05	Stop Beacon	593
Chapter 4M. Lane-Use Control Signals		
Section 4M.01	Application of Lane-Use Control Signals	595
Section 4M.02	Meaning of Lane-Use Control Signal Indications	595
Section 4M.03	Design of Lane-Use Control Signals	596
Section 4M.04	Operation of Lane-Use Control Signals.....	597
Chapter 4N. In-Roadway Lights		
Section 4N.01	Application of In-Roadway Lights	599
Section 4N.02	In-Roadway Warning Lights at Crosswalks	599
PART 5. TRAFFIC CONTROL DEVICES FOR LOW-VOLUME ROADS		
Chapter 5A. General		

Section 5A.01 Function 601

Section 5A.02 Application..... 601

Section 5A.03 Design 601

Section 5A.04 Placement..... 602

Chapter 5B. Regulatory Signs

Section 5B.01 Introduction..... 605

Section 5B.02 STOP and YIELD Signs (R1-1, R1-2)..... 605

Section 5B.03 Speed Limit Signs (R2 Series) 605

Section 5B.04 Traffic Movement and Prohibition Signs (R3, R4, R5, R6, R9, R10, R11, R12, R13, and R14 Series) 605

Section 5B.05 Parking Signs (R8 Series) 650

Section 5B.06 Other Regulatory Signs 606

Chapter 5C. Warning Signs

Section 5C.01 Introduction..... 607

Section 5C.02 Horizontal Alignment Signs (W1-1 through W1-8) 607

Section 5C.03 Intersection Warning Signs (W2-1 through W2-6)..... 608

Section 5C.04 Stop Ahead and Yield Ahead Signs (W3-1, W3-2) 608

Section 5C.05 NARROW BRIDGE Sign (W5-2) 608

Section 5C.06 ONE LANE BRIDGE Sign (W5-3)..... 608

Section 5C.07 Hill Sign (W7-1) 608

Section 5C.08 PAVEMENT ENDS Sign (W8-3) 608

Section 5C.09 Vehicular Traffic Warning and Non-Vehicular Warning Signs (W11 Series and W8-6) ... 608

Section 5C.10 Advisory Speed Plaque (W13-1P) 610

Section 5C.11 DEAD END or NO OUTLET Signs (W14-1, W14-1a, W14-2, W14-2a) 610

Section 5C.12 NO TRAFFIC SIGNS Sign (W18-1)..... 610

Section 5C.13 Other Warning Signs..... 610

Section 5C.14 Object Markers and Barricades..... 610

Chapter 5D. Guide Signs

Section 5D.01 Introduction..... 613

Chapter 5E. Markings

Section 5E.01 Introduction..... 615

Section 5E.02 Center Line Markings 615

Section 5E.03 Edge Line Markings..... 615

Section 5E.04 Delineators 615

Section 5E.05 Other Markings 615

Chapter 5F. Traffic Control for Highway-Rail Grade Crossings

Section 5F.01 Introduction..... 617

Section 5F.02 Grade Crossing (Crossbuck) Sign and Number of Tracks Plaque (R15-1, R15-2P) 617

Section 5F.03 Grade Crossing Advance Warning Signs (W10 Series)..... 617

Section 5F.04 STOP and YIELD Signs (R1-1, R1-2)..... 617

Section 5F.05 Pavement Markings..... 618

Section 5F.06 Other Traffic Control Devices 618

Chapter 5G. Temporary Traffic Control Zones

Section 5G.01 Introduction..... 619

Section 5G.02 Applications 619

Section 5G.03 Channelization Devices..... 620

Section 5G.04 Markings 620

Section 5G.05 Other Traffic Control Devices 620

Chapter 5H. Traffic Control for School Areas

Section 5H.01	Introduction.....	621
---------------	-------------------	-----

PART 6. TEMPORARY TRAFFIC CONTROL**Chapter 6A. General**

Section 6A.01	General.....	623
---------------	--------------	-----

Chapter 6B. Fundamental Principles

Section 6B.01	Fundamental Principles of Temporary Traffic Control	625
---------------	---	-----

Chapter 6C. Temporary Traffic Control Elements

Section 6C.01	Temporary Traffic Control Plans.....	629
Section 6C.02	Temporary Traffic Control Zones.....	630
Section 6C.03	Components of Temporary Traffic Control Zones	630
Section 6C.04	Advance Warning Area.....	630
Section 6C.05	Transition Area	632
Section 6C.06	Activity Area.....	633
Section 6C.07	Termination Area.....	635
Section 6C.08	Tapers.....	635
Section 6C.09	Detours and Diversions.....	636
Section 6C.10	One-Lane, Two-Way Traffic Control.....	637
Section 6C.11	Flagger Method of One-Lane, Two-Way Traffic Control	637
Section 6C.12	Flag Transfer Method of One-Lane, Two-Way Traffic Control.....	637
Section 6C.13	Pilot Car Method of One-Lane, Two-Way Traffic Control	639
Section 6C.14	Temporary Traffic Control Signal Method of One-Lane, Two-Way Traffic Control	639
Section 6C.15	Stop or Yield Control Method of One-Lane, Two-Way Traffic Control.....	639

Chapter 6D. Pedestrian and Worker Safety

Section 6D.01	Pedestrian Considerations.....	641
Section 6D.02	Accessibility Considerations.....	643
Section 6D.03	Worker Safety Considerations	644

Chapter 6E. Flagger Control

Section 6E.01	Qualifications for Flaggers	647
Section 6E.02	High-Visibility Safety Apparel.....	647
Section 6E.03	Hand-Signaling Devices	647
Section 6E.04	Automated Flagger Assistance Devices.....	649
Section 6E.05	STOP/SLOW Automated Flagger Assistance Devices	650
Section 6E.06	Red/Yellow Lens Automated Flagger Assistance Devices.....	653
Section 6E.07	Flagger Procedures.....	654
Section 6E.08	Flagger Stations	655

Chapter 6F. Temporary Traffic Control Zone Devices

Section 6F.01	Types of Devices.....	659
Section 6F.02	General Characteristics of Signs	659
Section 6F.03	Sign Placement	660
Section 6F.04	Sign Maintenance.....	668
Section 6F.05	Regulatory Sign Authority.....	668
Section 6F.06	Regulatory Sign Design	668
Section 6F.07	Regulatory Sign Applications	668
Section 6F.08	ROAD (STREET) CLOSED Sign (R11-2)	668
Section 6F.09	Local Traffic Only Signs (R11-3a, R11-3b, R11-4, R11-H8)	670
Section 6F.10	Weight Limit Signs (R12-1, R12-2,R12-H5).....	671

Section 6F.11 STAY IN LANE Sign (R4-9) 671

Section 6F.12 Work Zone and Higher Fines Signs and Plaques..... 671

Section 6F.13 PEDESTRIAN CROSSWALK Sign (R9-8)..... 672

Section 6F.14 SIDEWALK CLOSED Signs (R9-9, R9-10, R9-11, R9-11a) 672

Section 6F.15 Special Regulatory Signs 672

Section 6F.16 Warning Sign Function, Design, and Application 672

Section 6F.17 Position of Advance Warning Signs 673

Section 6F.18 ROAD (STREET) WORK Sign (W20-1)..... 674

Section 6F.19 DETOUR Sign (W20-2) 674

Section 6F.20 ROAD (STREET) CLOSED Sign (W20-3) 674

Section 6F.21 ONE LANE ROAD Sign (W20-4) 674

Section 6F.22 Lane(s) Closed Signs (W20-5, W20-5a) 674

Section 6F.23 CENTER LANE CLOSED AHEAD Sign (W9-3)..... 674

Section 6F.24 Lane Ends Sign (W4-2) 678

Section 6F.25 ON RAMP Plaque (W13-4P) 678

Section 6F.26 RAMP NARROWS Sign (W5-4) 678

Section 6F.27 SLOW TRAFFIC AHEAD Sign (W23-1) 678

Section 6F.28 EXIT OPEN and EXIT CLOSED (AHEAD) Signs (E5-2, E5-2a, E5-H2b, E5-H2c) 678

Section 6F.29 EXIT ONLY Sign (E5-3)..... 678

Section 6F.30 NEW TRAFFIC PATTERN AHEAD Sign (W23-2) 678

Section 6F.31 Flagger Signs (W20-7, W20-7a)..... 679

Section 6F.32 Two-Way Traffic Sign (W6-3) 679

Section 6F.33 Workers Signs (W21-1, W21-1a) 679

Section 6F.34 FRESH OIL (TAR) Sign (W21-2)..... 679

Section 6F.35 ROAD MACHINERY AHEAD Sign (W21-3) 679

Section 6F.36 Motorized Traffic Signs (W8-6, W11-10) 679

Section 6F.37 Shoulder Work Signs (W21-5, W21-5a, W21-5b)..... 680

Section 6F.38 SURVEY CREW Sign (W21-6)..... 680

Section 6F.39 UTILITY WORK Sign (W21-7)..... 680

Section 6F.40 Signs for Blasting Areas 681

Section 6F.41 BLASTING ZONE AHEAD Sign (W22-1) 681

Section 6F.42 TURN OFF 2-WAY RADIO AND CELL PHONE Sign (W22-2)..... 681

Section 6F.43 END BLASTING ZONE Sign (W22-3)..... 681

Section 6F.44 Shoulder Signs and Plaque (W8-4, W8-9, W8-17, W8-17P)..... 681

Section 6F.45 UNEVEN LANES Sign (W8-11) 681

Section 6F.46 STEEL PLATE AHEAD Sign (W8-24) 682

Section 6F.47 NO CENTER LINE and NO EDGE LINE Signs (W8-12,W8-H12a)..... 682

Section 6F.48 Reverse Curve Signs (W1-4 Series)..... 682

Section 6F.49 Double Reverse Curve Signs (W24-1 Series)..... 682

Section 6F.50 Other Warning Signs..... 682

Section 6F.50.1 Construction Arrow Sign (W1-H16)..... 683

Section 6F.51 Special Warning Signs..... 683

Section 6F.52 Advisory Speed Plaque (W13-1P) 683

Section 6F.53 Supplementary Distance Plaque (W7-3aP)..... 683

Section 6F.54 Motorcycle Plaque (W8-15P) 684

Section 6F.55 Guide Signs..... 684

Section 6F.56 ROAD WORK NEXT XX MILES Sign (G20-1)..... 684

Section 6F.57 END ROAD WORK Sign (G20-2)..... 684

Section 6F.58 PILOT CAR FOLLOW ME Sign (G20-4) 685

Section 6F.59 Detour Signs (M4-8, M4-8a, M4-8b, M4-9, M4-9a, M4-9b, M4-9c, M4-10)..... 685

Section 6F.60 Portable Changeable Message Signs..... 685

Section 6F.61 Arrow Boards..... 688

Section 6F.62 High-Level Warning Devices (Flag Trees)..... 689

Section 6F.63	Channelizing Devices	690
Section 6F.64	Cones	693
Section 6F.65	Tubular Markers	694
Section 6F.66	Vertical Panels	694
Section 6F.67	Drums.....	695
Section 6F.68	Type 1, 2, or 3 Barricades.....	695
Section 6F.69	Direction Indicator Barricades.....	696
Section 6F.70	Temporary Traffic Barriers as Channelizing Devices	697
Section 6F.71	Longitudinal Channelizing Devices.....	697
Section 6F.72	Temporary Lane Separators.....	698
Section 6F.73	Other Channelizing Devices	698
Section 6F.74	Detectable Edging for Pedestrians	698
Section 6F.75	Temporary Raised Islands.....	699
Section 6F.76	Opposing Traffic Lane Divider and Sign (W6-4).....	700
Section 6F.77	Pavement Markings	700
Section 6F.78	Temporary Markings	700
Section 6F.79	Temporary Raised Pavement Markers.....	701
Section 6F.80	Delineators.....	702
Section 6F.81	Lighting Devices.....	702
Section 6F.82	Floodlights	702
Section 6F.83	Warning Lights	703
Section 6F.84	Temporary Traffic Control Signals.....	704
Section 6F.85	Temporary Traffic Barriers.....	705
Section 6F.86	Crash Cushions	706
Section 6F.87	Rumble Strips	707
Section 6F.88	Screens.....	708
 Chapter 6G. Type of Temporary Traffic Control Zone Activities		
Section 6G.01	Typical Applications.....	709
Section 6G.02	Work Duration	709
Section 6G.03	Location of Work.....	711
Section 6G.04	Modifications To Fulfill Special Needs.....	711
Section 6G.05	Work Affecting Pedestrian and Bicycle Facilities.....	712
Section 6G.06	Work Outside of the Shoulder	713
Section 6G.07	Work on the Shoulder with No Encroachment.....	713
Section 6G.08	Work on the Shoulder with Minor Encroachment.....	714
Section 6G.09	Work Within the Median	714
Section 6G.10	Work Within the Traveled Way of a Two-Lane Highway	714
Section 6G.11	Work Within the Traveled Way of an Urban Street	715
Section 6G.12	Work Within the Traveled Way of Multi-Lane, Non-Access Controlled Highways.....	716
Section 6G.13	Work Within the Traveled Way at an Intersection	717
Section 6G.14	Work Within the Traveled Way of a Freeway or Expressway	718
Section 6G.15	Two-Lane, Two-Way Traffic on One Roadway of a Normally Divided Highway	719
Section 6G.16	Crossovers.....	719
Section 6G.17	Interchanges.....	719
Section 6G.18	Work in the Vicinity of a Grade Crossing	720
Section 6G.19	Temporary Traffic Control During Nighttime Hours	720
 Chapter 6H. Typical Applications		
Section 6H.01	Typical Applications.....	723
 Chapter 6I Control of Traffic Through Traffic Incident Management Areas		
Section 6I.01	General.....	821
Section 6I.02	Major Traffic Incidents	822

Section 6I.03 Intermediate Traffic Incidents..... 823
 Section 6I.04 Minor Traffic Incidents..... 824
 Section 6I.05 Use of Emergency-Vehicle Lighting 824

PART 7. TRAFFIC CONTROLS FOR SCHOOL AREAS

Chapter 7A. General

Section 7A.01 Need for Standards 825
 Section 7A.02 School Routes and Established School Crossings..... 825
 Section 7A.03 School Crossing Control Criteria 826
 Section 7A.04 Scope 826

Chapter 7B. Signs

Section 7B.01 Size of School Signs 828
 Section 7B.02 Illumination and Reflectorization 828
 Section 7B.03 Position of Signs 828
 Section 7B.04 Height of Signs 828
 Section 7B.05 Installation of Signs 828
 Section 7B.06 Lettering..... 828
 Section 7B.07 Sign Color for School Warning Signs..... 828
 Section 7B.08 School Sign (S1-1) and Plaques..... 831
 Section 7B.09 School Zone Ahead Assembly (S1-1, S4-3P, W16-2P, W16-2aP, W16-5P, W16-6P, W16-9P) 831
 Section 7B.10 School Speed Limit Assembly (S4-1P, S4-3P, S4-H8P, S4-6P), School Speed Limit Sign (S5-1), and END SCHOOL SPEED LIMIT Sign (S5-3) 831
 Section 7B.11 Higher Fines Zone Signs (R2-10, R2-11) and Plaques 833
 Section 7B.12 School Crossing Ahead Assembly..... 833
 Section 7B.13 School Crossing Assembly 833
 Section 7B.14 School Bus Stop Ahead Sign (S3-1) 834
 Section 7B.15 SCHOOL BUS TURN AHEAD Sign (S3-2)..... 834
 Section 7B.16 School Speed Limit Ahead Sign (S4-5, S4-5a)..... 834
 Section 7B.17 Parking and Stopping Signs (R7 and R8 Series)..... 835
 Section 7B.18 STOP FOR SCHOOL BUS LOADING OR UNLOADING Sign (R16-H3) 835

Chapter 7C. Markings

Section 7C.01 Functions and Limitations..... 841
 Section 7C.02 Crosswalk Markings 841
 Section 7C.03 Pavement Word, Symbol, and Arrow Markings 841

Chapter 7D. Crossing Supervision

Section 7D.01 Types of Crossing Supervision 843
 Section 7D.02 Adult Crossing Guards..... 843
 Section 7D.03 Qualifications of Adult Crossing Guards..... 843
 Section 7D.04 Uniform of Adult Crossing Guards..... 843
 Section 7D.05 Operating Procedures for Adult Crossing Guards 843

PART 8. TRAFFIC CONTROLS FOR RAILROAD AND LIGHT RAIL TRANSIT GRADE CROSSINGS

Chapter 8A. General

Section 8A.01 Introduction..... 845
 Section 8A.02 Use of Standard Devices, Systems, and Practices at Highway-Rail Grade Crossings..... 846
 Section 8A.03 Use of Standard Devices, Systems, and Practices at Highway-LRT Grade Crossings..... 846
 Section 8A.04 Uniform Provisions 847
 Section 8A.05 Grade Crossing Elimination..... 848

Section 8A.06	Illumination at Grade Crossings	848
Section 8A.07	Quiet Zone Treatments at Highway-Rail Grade Crossings.....	848
Section 8A.08	Temporary Traffic Control Zones.....	848

Chapter 8B. Signs and Markings

Section 8B.01	Purpose.....	851
Section 8B.02	Sizes of Grade Crossing Signs.....	851
Section 8B.03	Grade Crossing (Crossbuck) Sign (R15-1) and Number of Tracks Plaque (R15-2P) at Active and Passive Grade Crossings.....	851
Section 8B.04	Crossbuck Assemblies with YIELD or STOP Signs at Passive Grade Crossings	855
Section 8B.05	Use of STOP (R1-1) or YIELD (R1-2) Signs without Crossbuck Signs at Highway-LRT Grade Crossings	859
Section 8B.06	Grade Crossing Advance Warning Signs (W10 Series)	860
Section 8B.07	EXEMPT Grade Crossing Plaques (R15-3P, W10-1aP)	861
Section 8B.08	Turn Restrictions During Preemption.....	861
Section 8B.09	DO NOT STOP ON TRACKS Sign (R8-8)	862
Section 8B.10	TRACKS OUT OF SERVICE Sign (R8-9).....	862
Section 8B.11	STOP HERE WHEN FLASHING Signs (R8-10, R8-10a)	862
Section 8B.12	STOP HERE ON RED Signs (R10-6, R10-6a)	862
Section 8B.13	Light Rail Transit Only Lane Signs (R15-4 Series).....	863
Section 8B.14	Do Not Pass Light Rail Transit Signs (R15-5, R15-5a).....	863
Section 8B.15	No Motor Vehicles On Tracks Signs (R15-6, R15-6a).....	863
Section 8B.16	Divided Highway with Light Rail Transit Crossing Signs (R15-7 Series).....	864
Section 8B.17	LOOK Sign (R15-8)	864
Section 8B.18	Emergency Notification Sign (I-13)	864
Section 8B.19	Light Rail Transit Approaching-Activated Blank-Out Warning Sign (W10-7)	865
Section 8B.20	TRAINS MAY EXCEED 80 MPH Sign (W10-8)	865
Section 8B.21	NO TRAIN HORN Sign or Plaque (W10-9, W10-9P).....	865
Section 8B.22	NO GATES OR LIGHTS Plaque (W10-13P)	865
Section 8B.23	Low Ground Clearance Grade Crossing Sign (W10-5).....	865
Section 8B.24	Storage Space Signs (W10-11, W10-11a, W10-11b)	866
Section 8B.25	Skewed Crossing Sign (W10-12).....	866
Section 8B.26	Light Rail Transit Station Sign (I-12)	866
Section 8B.27	Pavement Markings	866
Section 8B.28	Stop and Yield Lines.....	868
Section 8B.29	Dynamic Envelope Markings	869

Chapter 8C. Flashing-Light Signals, Gates, and Traffic Control Signals

Section 8C.01	Introduction.....	873
Section 8C.02	Flashing-Light Signals.....	875
Section 8C.03	Flashing-Light Signals at Highway-LRT Grade Crossings	876
Section 8C.04	Automatic Gates	876
Section 8C.05	Use of Automatic Gates at LRT Grade Crossings	877
Section 8C.06	Four-Quadrant Gate Systems	877
Section 8C.07	Wayside Horn Systems	880
Section 8C.08	Rail Traffic Detection	880
Section 8C.09	Traffic Control Signals at or Near Highway-Rail Grade Crossings	880
Section 8C.10	Traffic Control Signals at or Near Highway-LRT Grade Crossings.....	882
Section 8C.11	Use of Traffic Control Signals for Control of LRT Vehicles at Grade Crossings	883
Section 8C.12	Grade Crossings Within or In Close Proximity to Circular Intersections.....	885
Section 8C.13	Pedestrian and Bicycle Signals and Crossings at LRT Grade Crossings.....	885

Chapter 8D. Pathway Grade Crossings

Section 8D.01	Purpose.....	891
---------------	--------------	-----

Section 8D.02 Use of Standard Devices, Systems, and Practices..... 891
 Section 8D.03 Pathway Grade Crossing Signs and Markings 891
 Section 8D.04 Stop Lines, Edge Lines, and Detectable Warnings 891
 Section 8D.05 Passive Devices for Pathway Grade Crossings 892
 Section 8D.06 Active Traffic Control Systems for Pathway Grade Crossings 893

PART 9. TRAFFIC CONTROLS FOR BICYCLE FACILITIES

Chapter 9A. General

Section 9A.01 Requirements for Bicyclist Traffic Control Devices 895
 Section 9A.02 Scope..... 895
 Section 9A.03 Definitions Relating to Bicycles 895
 Section 9A.04 Maintenance 895
 Section 9A.05 Relation to Other Documents..... 895
 Section 9A.06 Placement Authority 895
 Section 9A.07 Meaning of Standard, Guidance, Option, and Support 895
 Section 9A.08 Colors..... 896

Chapter 9B. Signs

Section 9B.01 Application and Placement of Signs 897
 Section 9B.02 Design of Bicycle Signs..... 897
 Section 9B.03 STOP and YIELD Signs (R1-1, R1-2)..... 897
 Section 9B.04 Bike Lane Signs and Plaques (R3-17, R3-17aP, R3-17bP) 898
 Section 9B.05 BEGIN RIGHT TURN LANE YIELD TO BIKES Sign (R4-4)..... 902
 Section 9B.06 Bicycles MAY USE FULL LANE Sign (R4-11) 902
 Section 9B.07 Bicycle WRONG WAY Sign and RIDE WITH TRAFFIC Plaque (R5-1b, R9-3cP) 902
 Section 9B.08 NO MOTOR VEHICLES Sign (R5-3) 902
 Section 9B.09 Selective Exclusion Signs 902
 Section 9B.10 No Parking BIKE LANE Signs (R7-9, R7-9a) 903
 Section 9B.11 Bicycle Regulatory Signs (R9-5, R9-6, R10-4, R10-24, R10-25, R10-26) 903
 Section 9B.12 Shared-Use Path Restriction Sign (R9-7) 903
 Section 9B.13 Bicycle Signal Actuation Sign (R10-22)..... 904
 Section 9B.14 Other Regulatory Signs 904
 Section 9B.15 Turn or Curve Warning Signs (W1 Series)..... 904
 Section 9B.16 Intersection Warning Signs (W2 Series)..... 904
 Section 9B.17 Bicycle Surface Condition Warning Sign (W8-10) 904
 Section 9B.18 Bicycle Warning and Combined Bicycle/Pedestrian Signs (W11-1, W11-15)..... 904
 Section 9B.19 Other Bicycle Warning Signs 906
 Section 9B.20 Bicycle Guide Signs (D1-1b, D1-1c, D1-2b, D1-2c, D1-3b, D1-3c, D11-1, D11-1c)..... 906
 Section 9B.21 Bicycle Route Signs (M1-8, M1-8a, M1-9) 907
 Section 9B.22 Bicycle Route Sign Auxiliary Plaques..... 910
 Section 9B.23 Bicycle Parking Area Sign (D4-3) 912
 Section 9B.24 Reference Location Signs (D10-1 through D10-3) and Intermediate Reference Location Signs (D10-1a through D10-3a)..... 912
 Section 9B.25 Mode-Specific Guide Signs for Shared-Use Paths (D11-1a, D11-2, D11-3, D11-4) 913
 Section 9B.26 Object Markers..... 913

Chapter 9C. Markings

Section 9C.01 Functions of Markings 915
 Section 9C.02 General Principles 915
 Section 9C.03 Marking Patterns and Colors on Shared-Use Paths 915
 Section 9C.04 Markings For Bicycle Lanes 915
 Section 9C.05 Bicycle Detector Symbol 919
 Section 9C.06 Pavement Markings for Obstructions..... 919

Section 9C.07 Shared Lane Marking..... 919

Chapter 9D. Signals

Section 9D.01 Application..... 925

Section 9D.02 Signal Operations for Bicycles 925

APPENDIX A LEGISLATION RELATED TO THE NATIONAL MUTCD AND METRIC CONVERSIONS

Appendix A1 Congressional Legislation Regarding the National MUTCD.....A1-1

Appendix A2 Metric Conversions A2-1

APPENDIX B OHIO REVISED CODE MATERIAL RELATED TO THE OMUTCD

Appendix B1 Cross-Reference Guide to the Ohio Revised Code B1-1

Appendix B2 Ohio Revised Code SectionsB2-1

APPENDIX C SIGNING INDEX

Regulatory Signs C-1

Warning Signs C-14

Guide Signs – Marker Series C-24

Guide Signs – Directional Series C-27

Guide Signs – Freeways, Expressways and Miscellaneous..... C-32

Guide Signs – Information Series C-35

Recreational and Cultural Interest Series C-37

Emergency Management Series..... C-38

Object Markers and End-of-Roadway Markers..... C-39

School Area Signs..... C-40

APPENDIX D INDEX (Future)

FIGURES

	Page
Figure 1A-1. Process for Requesting and Conducting Experimenting for New Traffic Control Devices	7
Figure 1A-2. Process for Incorporating New Traffic Control Devices into the National MUTCD	9
Figure 2A-1. Examples of Enhanced Conspicuity for Signs.....	45
Figure 2A-2. Examples of Heights and Lateral Locations of Sign Installations	46
Figure 2A-3. Examples of Locations for Some Typical Signs at Intersections.....	47
Figure 2A-4. Relative Locations of Regulatory, Warning, and Guide Signs on an Intersection Approach	48
Figure 2B-1. STOP and YIELD Signs and Plaques.....	63
Figure 2B-2. Unsignalized Pedestrian Crosswalk Signs	67
Figure 2B-3. Speed Limit and Photo Enforcement Signs and Plaques	69
Figure 2B-4. Movement Prohibition and Lane Control Signs and Plaques	72
Figure 2B-5. Intermediate Lane Control Sign Arrow Options for Roundabouts	75
Figure 2B-6. Center and Reversible Lane Control Signs and Plaques.....	78
Figure 2B-7. Location of Reversible Two-Way Left-Turn Signs	79
Figure 2B-8. Jughandle Regulatory Signs.....	81
Figure 2B-9. Examples of Applications of Jughandle Regulatory and Guide Signing	82
Figure 2B-10. Passing , Keep Right, and Truck Lane Signs.....	86
Figure 2B-11. Selective Exclusion Signs	89
Figure 2B-12. Locations of Wrong-Way Signing for Divided Highway with Median Widths of 30 Feet or Wider	90
Figure 2B-13. ONE WAY and Divided Highway Crossing Signs	92

Figure 2B-14.	Locations of ONE WAY Signs	93
Figure 2B-15.	ONE WAY Signing for Divided Highways with Median Widths of 30 Feet or Wider.....	94
Figure 2B-16.	ONE WAY Signing for Divided Highways with Medians Widths Narrower Than 30 Feet	95
Figure 2B-17.	ONE WAY Signing for Divided Highways with Medians Narrower Than 30 Feet and Separated Left-Turn Lanes.....	96
Figure 2B-18.	Example of Application of Regulatory Signing and Pavement Markings at an Exit Ramp Termination to Deter Wrong-Way Entry	97
Figure 2B-19.	Example of Application of Regulatory Signing and Pavement Markings at an Entrance Ramp Terminal Where the Design Does Not Clearly Indicate the Direction of Flow.....	97
Figure 2B-20.	Roundabout Signs and Plaques	98
Figure 2B-21.	Example of Regulatory and Warning Signs for a Mini-Roundabout.....	99
Figure 2B-22.	Example of Regulatory and Warning Signs for a One-Lane Roundabout.....	100
Figure 2B-23.	Examples of Regulatory and Warning Signs for a Two-Lane Roundabout with Consecutive Double Lefts	101
Figure 2B-24.	Parking and Standing Signs and Plaques (R7 Series)	103
Figure 2B-25.	Parking and Stopping Signs and Plaques (R8 Series).....	105
Figure 2B-26.	Pedestrian Signs and Plaques	108
Figure 2B-27.	Traffic Signal Signs and Plaques	111
Figure 2B-28.	Ramp Metering Signs.....	113
Figure 2B-29.	Road Closed and Weight Limit Signs	114
Figure 2B-30.	Truck Signs	115
Figure 2B-31.	Headlight Use Signs.....	116
Figure 2B-32.	Other Regulatory Signs	116
Figure 2C-1.	Horizontal Alignment Signs and Plaques	127
Figure 2C-2.	Example of Warning Signs for a Turn	129
Figure 2C-3.	Example of Advisory Speed Signing for an Exit Ramp.....	134
Figure 2C-4.	Vertical Grade Signs and Plaques	135
Figure 2C-5.	Miscellaneous Warning Signs.....	136
Figure 2C-6.	Roadway and Weather Condition and Advance Traffic Control Signs and Plaques	139
Figure 2C-7.	Reduced Speed Limit Ahead Signs.....	143
Figure 2C-8.	Merging and Passing Signs and Plaques.....	144
Figure 2C-9.	Intersection Warning Signs and Plaques.....	147
Figure 2C-10.	Vehicular Traffic Warning Signs and Plaques.....	149
Figure 2C-11.	Non-Vehicular Warning Signs.....	150
Figure 2C-12.	Supplemental Warning Plaques	152
Figure 2C-13.	Object Markers.....	155
Figure 2D-1.	Examples of Color-Coded Destination Guide Signs.....	158
Figure 2D-2.	Arrows for Use on Guide Signs	162
Figure 2D-3.	Route Signs	165
Figure 2D-4.	Route Sign Auxiliaries	167
Figure 2D-5.	Advance Turn and directional Arrow Auxiliary Signs	169
Figure 2D-6.	Illustration of Directional Assemblies and Other Route Signs (for One Direction of Travel Only).....	171
Figure 2D-7.	Destination and Distance Signs.....	177
Figure 2D-8.	Destination Signs for Roundabouts.....	180
Figure 2D-9.	Examples of Guide Signs for Roundabouts	181
Figure 2D-10.	Street Name and Parking Signs.....	184
Figure 2D-11.	Example of Interchange Crossroad Signing for a One-Lane Approach.....	188
Figure 2D-12.	Example of Minor Interchange Crossroad Signing.....	189
Figure 2D-13.	Examples of Multi-Lane Crossroad Signing for a Diamond Interchange.....	190
Figure 2D-14.	Examples of Multi-Lane Crossroad Signing for a Partial Cloverleaf Interchange	191
Figure 2D-15.	Examples of Multi-Lane Crossroad signing for a Cloverleaf Interchange	192

Figure 2D-16.	Example of Crossroad Signing for an Entrance Ramp with a nearby Frontage Road	193
Figure 2D-17.	Example of Weigh Station Signing.....	196
Figure 2D-18.	Examples of community Wayfinding Guide Signs.....	197
Figure 2D-19.	Example of a Community Wayfinding Guide Sign System Showing Direction from a Freeway of Expressway	198
Figure 2D-20.	Example of a Color-Coded Community Wayfinding Guide Sign System	199
Figure 2D-21.	Crossover, Truck Lane, and slow Vehicle Signs	203
Figure 2D-22.	Examples of Use of the National Scenic Byways Sign	204
Figure 2D-23.	Ohio Byway Signs	205
Figure 2E-1.	Example of Guide Sign Spreading.....	210
Figure 2E-2.	Pull-Through Signs	211
Figure 2E-3.	Overhead Arrow-per-Lane Guide Sign for a Multi-Lane Exit with an Option Lane.....	218
Figure 2E-4.	Overhead Arrow-per-Lane Guide Signs for a Two-Lane Exit to the Right with an Option Lane	219
Figure 2E-5.	Overhead Arrow-per-Lane Guide Signs for a Two-Lane Exit to the Right with an Option Lane (Through Lanes Curve to the Left)	220
Figure 2E-6.	Overhead Arrow-per-Lane Guide Signs for a Split with an Option Lane	221
Figure 2E-7.	Diagrammatic Guide Sign for a Multi-Lane Exit with an Option Lane	223
Figure 2E-8.	Diagrammatic Guide Signs for a Two-Lane Exit to the Right with an Optional Lane.....	224
Figure 2E-9.	Diagrammatic Guide Signs for a Two-Lane Exit to the Right with an Optional Lane (Through Lanes Curve to the Left)	225
Figure 2E-10.	Diagrammatic Guide Signs for a Split with an Option Lane	226
Figure 2E-11.	Example of Signing for a Two-Lane Intermediate or Minor Interchange Exit with an Option Lane and a Dropped Lane	228
Figure 2E-12.	Example of Signing for a Two-Lane Intermediate or Minor Interchange Exit with Option and Auxiliary Lanes.....	229
Figure 2E-13.	EXIT ONLY and LEFT Sign Panels	230
Figure 2E-14.	Guide Signs for a Split with Dedicated Lanes	231
Figure 2E-15.	Guide Signs for a Single-Lane Exit to the Left with a Dropped lane	232
Figure 2E-16.	Guide Signs for a Single-Lane Exit to the Right with a Dropped Lane.....	233
Figure 2E-17.	Interstate, Off-Interstate and U.S. Route Signs.....	235
Figure 2E-18.	Eisenhower Interstate System Sign.....	236
Figure 2E-19.	Example of Interchange Numbering for Mainline and Circumferential Routes.....	238
Figure 2E-20.	Example of Interchange Numbering for Mainline, Loop, and Spur Routes	239
Figure 2E-21.	Example of Interchange Numbering for Overlapping Routes	240
Figure 2E-22.	Examples of Interchange Advance Guide Signs, Exit Number Plaques, and LEFT Plaque.....	243
Figure 2E-23.	Next Exit Plaques.....	244
Figure 2E-24.	Supplemental Guide Signs for a Multi-Exit Interchange.....	245
Figure 2E-25.	Supplemental Guide sign for a Park-Ride Facility	245
Figure 2E-26.	Example of Interchange Exit Direction Signs.....	246
Figure 2E-27.	Interchange Exit Direction Sign with an Advisory Speed Panel	248
Figure 2E-28.	Exit Gore Signs	248
Figure 2E-29.	Post-Interchange Distance Sign	249
Figure 2E-30.	Example of Using an Interchange Sequence Sign for Closely-Spaced Interchanges	251
Figure 2E-31.	Interchange Sequence Sign	252
Figure 2E-32.	Community Interchanges Identification Sign	252
Figure 2E-33.	NEXT EXITS Sign	252
Figure 2E-34.	Examples of Guide Signs for a Freeway-to-Freeway Interchange	254
Figure 2E-35.	Examples of Guide Signs for Full Cloverleaf Interchange	256
Figure 2E-36.	Examples of Guide Signs for Full Cloverleaf Interchange with Collector-Distributor Roadways	257
Figure 2E-37.	Examples of Guide Signs for a Partial Cloverleaf Interchange	258

Figure 2E-38.	Examples of Guide Signs for a Diamond Interchange.....	260
Figure 2E-39.	Examples of Guide Signs for a Diamond Interchange in an Urban Area.....	262
Figure 2E-40.	Examples of Guide Signs for a Minor Interchange.....	263
Figure 2F-1.	Examples of ETC Account Pictographs and Use of Purple Backgrounds and Underlay Panels.....	267
Figure 2F-2.	Toll Plaza Regulatory Signs and Plaques.....	268
Figure 2F-3.	Toll Plaza Warning Signs and Plaques.....	270
Figure 2F-4.	ETC Account-Only Auxiliary Signs for Use in Route Sign Assemblies.....	271
Figure 2F-5.	Examples of Guide Signs for Entrances to Toll Highways or Ramps.....	274
Figure 2F-6.	Examples of Guide Signs for the Entrance to a Toll Highway on which Tolls are Collected Electronically Only.....	275
Figure 2F-7.	Examples of Guide Signs for Alternative Toll and Non-Toll Ramp Connections to a Non-Toll Highway.....	276
Figure 2F-8.	Examples of Conventional Toll Plaza Advance Signs.....	277
Figure 2F-9.	Examples of Toll Plaza Canopy Signs.....	277
Figure 2F-10.	Examples of a Mainline Toll Plaza Approach and Canopy Signing.....	280
Figure 2F-11.	Examples of Guide Signs for a Mainline Toll Plaza on a Diverging Alignment from Open-Road ETC Lanes.....	281
Figure 2G-1.	Preferential Lane Regulatory Signs and Plaques.....	287
Figure 2G-2.	Example of Signing for an Added Continuous-Access Contiguous or Buffer-Separated HOV Lane.....	292
Figure 2G-3.	Example of Signing for a General-Purpose Lane that Becomes a Continuous or Buffer-Separated HOV Lane.....	293
Figure 2G-4.	Examples of Warning Signs and Plaques Applicable Only to Preferential Lanes.....	296
Figure 2G-5.	Example of an Overhead Advance Guide Sign for a Preferential Lane Entrance.....	299
Figure 2G-6.	Examples of Overhead or Post-Mounted Preferential Lane Entrance Direction Signs.....	299
Figure 2G-7.	Entrance Gore Signs for Barrier-Separated Preferential Lanes.....	300
Figure 2G-8.	Example of Signing for an Entrance to Access-Restricted HOV Lanes.....	301
Figure 2G-9.	Example of Signing for an Intermediate Entry to a Barrier- or Buffer-Separated HOV Lane.....	303
Figure 2G-10.	Example of Signing for the Intermediate Entry to, Egress from, and End of Access-Restricted HOV Lanes.....	304
Figure 2G-11.	Examples of Barrier-Mounted Guide Signs for an Intermediate Egress from Preferential Lanes.....	305
Figure 2G-12.	Examples of Signs for an Intermediate Egress from a Barrier- or Buffer-Separated HOV Lane.....	306
Figure 2G-13.	Example of Signing for a Direct Entrance Ramp to an HOV Lane from a Park - Ride Facility and a Local Street.....	307
Figure 2G-14.	Exit Gore Sign for a Direct Exit from a Preferential Lane.....	308
Figure 2G-15.	Examples of Guide Signs for Direct HOV Lane Entrance and Exit Ramps.....	309
Figure 2G-16.	Examples of Guide Signs for a Direct Access Ramp between HOV Lanes on Separate Freeways.....	310
Figure 2G-17.	Regulatory Signs for Managed Lanes.....	312
Figure 2G-18.	Examples of Guide Signs for Entrances to Priced Managed Lanes.....	313
Figure 2G-19.	Example of an Exit Destination Sign for a Managed Lane.....	314
Figure 2G-20.	Example of a Comparative Travel Time Information Sign for Preferential or Managed Lanes.....	315
Figure 2G-21.	Example of Signing for the Entrance to an Access-Restricted Priced Managed Lane.....	316
Figure 2G-22.	Example of Signing for the Entrance to an Access-Restricted Priced Managed Lane Where a General-Purpose Lane Becomes the Managed Lane.....	317
Figure 2G-23.	Example of Signing for an Intermediate Entry to a Barrier- or Buffer-Separated	

	Priced Managed Lane	318
Figure 2G-24.	Example of Signing for the Intermediate Entry to, Egress from, and End of Access-Restricted Priced Managed Lane.....	319
Figure 2G-25.	Example of Guide Signs for an Intermediate Egress from a Barrier- or Buffer-Separated Managed Lane	320
Figure 2G-26.	Examples of Guide Signs for Direct Managed Lane Entrance and Exit Ramps.....	321
Figure 2G-27.	Examples of Guide Signs for a Direct Access Ramp between Managed Lanes on Separate Freeways	322
Figure 2G-28.	Examples of Guide Signs for a Direct Entrance Ramp to a Priced Managed Lane and Trailblazing to a Nearby Entrance to the General-Purpose Lanes	323
Figure 2G-29.	Example of Guide Signs for Separate Entrance Ramps to General-Purpose and Priced Managed Lanes from the Same Crossroad	324
Figure 2H-1.	General Information and Miscellaneous Information Signs	327
Figure 2H-2.	Reference Location Signs	329
Figure 2H-3.	Intermediate Reference Location Signs	329
Figure 2H-4.	Enhanced Reference Location Signs.....	331
Figure 2H-5.	Examples of Acknowledgement Sign Designs	333
Figure 2I-1.	General Service Signs and Plaques.....	337
Figure 2I-2.	Example of Next Services Plaque.....	338
Figure 2I-3.	Examples of General Service Signs with and without Exit Numbering	340
Figure 2I-4.	Examples of Interstate Oasis Signs and Plaques.....	342
Figure 2I-5.	Rest Area and Other Roadside Area Signs	343
Figure 2I-6.	Brake Check Area and Chain-Up Area Signs.....	344
Figure 2I-7.	Examples of Tourist Information and Welcome Center Signs	345
Figure 2I-8.	Radio, Telephone, and Carpool Information Signs.....	346
Figure 2J-1.	Examples of Specific Service Signs.....	350
Figure 2J-2.	Examples of Specific Service Sign Locations	351
Figure 2J-3.	Examples of Supplemental Messages on Logo Sign Panels.....	352
Figure 2J-4.	Examples of RV Access Supplemental Messages on Logo Sign Panels	353
Figure 2J-5.	Examples of Specific Service Trailblazer Signs	356
Figure 2K-1.	Examples of Tourist-Oriented Directional Signs.....	359
Figure 2K-2.	Examples of Intersection Approach Signs and Advance Signs for Tourist-Oriented Directional Signs.....	360
Figure 2M-1.	Examples of Use of Arrows, Educational Plaques, and Prohibitive Slashes	372
Figure 2M-2.	Examples of General Directional Guide Signs for Conventional Roads	373
Figure 2M-3.	Arrangement, Height, and Lateral Position of Signs Located Within Recreational and Cultural Interest Areas	374
Figure 2M-4.	Examples of Symbol and Destination Guide Signing Layout	375
Figure 2M-5.	Recreational and Cultural Interest Area Symbol Signs for General Applications.....	376
Figure 2M-6.	Recreational and Cultural Interest Area Symbol Signs for Accommodations.....	377
Figure 2M-7.	Recreational and Cultural Interest Area Symbol Signs for Services.....	
Figure 2M-8.	Recreational and Cultural Interest Area Symbol Signs for Land Recreation	377
Figure 2M-9.	Recreational and Cultural Interest Area Symbol Signs for Water Recreation.....	378
Figure 2M-10.	Recreational and Cultural Interest Area Symbol Signs for Winter Recreation.....	379
Figure 3B-1.	Examples of Two-Lane, Two-Way Marking Applications.....	394
Figure 3B-2.	Examples of Four-or-More Lane, Two-Way Marking Applications	395
Figure 3B-3.	Examples of Three-Lane, Two-Way Marking Applications.....	396
Figure 3B-4.	Method of Locating and Determining the Limits of No-Passing Zones at Curves.....	397
Figure 3B-5.	Example of Three-Lane, Two-Way Marking for Changing Direction of the Center Lane.....	400
Figure 3B-6.	Example of Reversible Lane Marking Application	401
Figure 3B-7.	Example of Two-Way Left-Turn Lane Marking Applications	402
Figure 3B-8.	Examples of Dotted Line and Channelizing Line Applications for Exit Ramp Markings ..	403

Figure 3B-9.	Examples of Dotted Line and Channelizing Line Applications for Entrance Ramp Markings	405
Figure 3B-10.	Examples of Applications of Freeway and Expressway Lane Drop Markings.....	408
Figure 3B-11.	Examples of Applications of Conventional Road Lane-Drop Markings	413
Figure 3B-12.	Example of Solid Double White Lines Used to Prohibit Lane Changing.....	415
Figure 3B-13.	Examples of Line Extensions through Intersections	418
Figure 3B-14.	Examples of Applications of Lane-Reduction Transition Markings	420
Figure 3B-15.	Examples of Applications of Markings for Obstructions in the Roadway.....	422
Figure 3B-16.	Recommended Yield Line Layouts.....	428
Figure 3B-17.	Examples of Yield Lines at Unsignalized Midblock Crosswalks	429
Figure 3B-18.	Do Not Block Intersection Markings	430
Figure 3B-19.	Examples of Crosswalk Markings	420
Figure 3B-20.	Example of Crosswalk Markings for an Exclusive Pedestrian Phase that Permits Diagonal Crossing.....	432
Figure 3B-21.	Examples of Parking Space Markings	433
Figure 3B-22.	International Symbol of Accessibility Parking Space Marking	434
Figure 3B-23.	Example of Elongated Letters for Word Pavement Markings	435
Figure 3B-24.	Examples of Standard Arrows for Pavement Markings.....	436
Figure 3B-25.	Examples of Elongated Route Shields for Pavement Markings	437
Figure 3B-26.	Yield Ahead Triangle Symbols.....	438
Figure 3B-27.	Examples of Lane-Use Control Word and Symbol Markings	439
Figure 3B-28.	Example of the Application of Speed Reduction Markings.....	441
Figure 3B-29.	Pavement Markings for Speed Humps without Crosswalks	443
Figure 3B-30.	Pavement Markings for Speed Tables or Speed Humps with Crosswalks.....	444
Figure 3B-31.	Advance Warning Markings for Speed Humps	445
Figure 3C-1.	Example of Markings for Approach and Circulatory Roadways at a Roundabout.....	447
Figure 3C-2.	Lane-Use Arrow Pavement Marking Options for Roundabout Approaches	448
Figure 3C-3.	Example of Markings for a One-Lane Roundabout.....	448
Figure 3C-4.	Example of Markings for a Two-Lane Roundabout with One- and Two-Lane Approaches	449
Figure 3C-5.	Example of Markings for a Two-Lane Roundabout with One-Lane Exits	451
Figure 3C-6.	Example of Markings for a Two-Lane Roundabout with Two-Lane Exits	452
Figure 3C-7.	Example of Markings for a Two-Lane Roundabout with a Double Left Turn	453
Figure 3C-8.	Example of Markings for a Two-Lane Roundabout with a Double Right Turn	454
Figure 3C-9.	Example of Markings for a Two-Lane Roundabout with Consecutive Double Left Turns.....	455
Figure 3C-10.	Example of Markings for a Three-Lane Roundabout with Two- and Three-Lane Approaches	456
Figure 3C-11.	Example of Markings for a Three-Lane Roundabout with Three-Lane Approaches	457
Figure 3C-12.	Example of Markings for a Three-Lane Roundabout with Two-Lane Exits	458
Figure 3C-13.	Example of Markings for Two Linked Roundabouts.....	459
Figure 3C-14.	Example of Markings for a Diamond Interchange with Two Circular-Shaped Roundabout Ramp Terminals.....	460
Figure 3D-1.	Markings for Barrier-Separated Preferential Lanes	467
Figure 3D-2.	Markings for Buffer-Separated Preferential Lanes	467
Figure 3D-3.	Markings for Contiguous Preferential Lanes	469
Figure 3D-4.	Markings for Counter-Flow Preferential Lanes on Divided Highways	471
Figure 3F-1.	Examples of Delineator Placement	476
Figure 3J-1.	Examples of Longitudinal Rumble Strip Markings	485
Figure 4C-1.	Warrant 2, Four-Hour Vehicular Volume.....	497
Figure 4C-2.	Warrant 2, Four-Hour Vehicular Volume (70% Factor).....	497
Figure 4C-3.	Warrant 3, Peak Hour.....	498

Figure 4C-4.	Warrant 3, Peak Hour (70% Factor)	498
Figure 4C-5.	Warrant 4, Pedestrian Four-Hour Volume	501
Figure 4C-6.	Warrant 4, Pedestrian Four-Hour Volume (70% Factor).....	501
Figure 4C-7.	Warrant 4, Pedestrian Peak Hour	502
Figure 4C-8.	Warrant 4, Pedestrian Peak Hour (70% Factor).....	502
Figure 4C-9.	Warrant 9, Intersection Near a Grade crossing (One Approach Lane at the Track Crossing).....	505
Figure 4C-10.	Warrant 9, Intersection Near a Grade Crossing (Two or More Approach Lanes at the Track Crossing).....	505
Figure 4D-1.	Example of U-Turn Signal Face	517
Figure 4D-2.	Typical Arrangements of Signal Sections in Signal Faces That Do Not Control Turning Movements.....	519
Figure 4D-3.	Recommended Vehicular Signal Faces for Approaches with Posted, Statutory, or 85 th -Percentile Speed of 45 mph or Higher	521
Figure 4D-4.	Lateral and Longitudinal Location of Primary Signal Faces	525
Figure 4D-5.	Maximum Mounting Height of Signal Faces Located Between 40 Feet and 53 Feet from Stop Line	527
Figure 4D-6.	Typical Position and Arrangements of Shared Signal Faces for Permissive Only Mode Left Turns	529
Figure 4D-7.	Typical Position and Arrangements of Separate Signal Faces with Flashing Yellow Arrow for Permissive Only Mode Left Turns	530
Figure 4D-8.	Typical Position and Arrangements of Separate Signal Faces with Red Arrow for Protected Only Mode Left Turns.....	532
Figure 4D-9.	Typical Positions and Arrangements of Shared Signal Faces for Protected Only Mode Left Turns	533
Figure 4D-10.	Typical Position and Arrangements of Separate Signal Faces for Protected Only Mode Left Turns	534
Figure 4D-11.	Typical Position and Arrangements of Shared Signal Faces for Protected/Permissive Mode Left Turns	535
Figure 4D-12.	Typical Position and Arrangements of Separate Signal Faces with Flashing Yellow Arrow for Protected/Permissive Mode and Protected Only Mode Left Turn	536
Figure 4D-13.	Typical Positions and Arrangements of Shared Signal Faces for Permissive Only Mode Right Turns	538
Figure 4D-14.	Typical Position and Arrangements of Separate Signal Faces with Flashing Yellow Arrow for Permissive Only Mode Right Turns	539
Figure 4D-15.	Reserved for Future Use.....	540
Figure 4D-16.	Typical Position and Arrangements of Shared Signal Faces for Protected Only Mode Right Turns.....	540
Figure 4D-17.	Typical Position and Arrangements of Separate Signal Faces for Protected Only Mode Right Turns	541
Figure 4D-18.	Typical Position and Arrangements of Shared Signal Faces for Protected/Permissive Mode Right Turns.....	542
Figure 4D-19.	Typical Position and Arrangements of Separate Signal Faces with Flashing Yellow Arrow for Protected/Permissive Mode and Protected Only Mode Right Turns	544
Figure 4D-20.	Signal Indications for Approaches with a Shared Left-Turn/Right-Turn Lane and No Through Movement.....	546
Figure 4E-1.	Typical Pedestrian Signal Indications.....	559
Figure 4E-2.	Pedestrian Intervals.....	561
Figure 4E-3.	Pushbutton Locations Area.....	564
Figure 4E-4.	Typical Pushbutton Locations.....	565
Figure 4F-1.	Guidelines for the Installation of Pedestrian Hybrid Beacons on Low-Speed Roadways ...	574
Figure 4F-2.	Guidelines for the Installation of Pedestrian Hybrid Beacons on High-Speed Roadways ..	574
Figure 4F-3.	Sequence for a Pedestrian Hybrid Beacon.....	575

Figure 4G-1. Sequence for an Emergency-Vehicle Hybrid Beacon..... 579

Figure 4M-1. Left-Turn Lane-Use Control Signals 596

Figure 5B-1. Regulatory Signs on Low-volume Roads 606

Figure 5B-2. Parking Signs and Plaques on Low-Volume Roads..... 606

Figure 5C-1. Horizontal Alignment and Intersection Warning Signs and Plaques and Object Markers on Low-Volume Roads 607

Figure 5C-2. Other Warning Signs and Plaques on Low-Volume Roads 609

Figure 5F-1. Highway-Rail Grade Crossing Signs and Plaques for Low-Volume Roads 618

Figure 5G-1. Temporary Traffic Control Signs and Plaques on Low-Volume Roads 620

Figure 6C-1. Component Parts of a Temporary Traffic Control Zone..... 631

Figure 6C-2. Types of Tapers and Buffer Spaces 634

Figure 6C-3. Example of a One-Lane, Two-Way Traffic Taper..... 638

Figure 6E-1. Example of the Use of a STOP/SLOW Automated Flagger Assistance Device (AFAD)..... 651

Figure 6E-2. Example of the Use of a Red/Yellow Lens Automated Flagger Assistance Device (AFAD)..... 652

Figure 6E-3. Use of Hand-Signaling Devices by Flaggers 656

Figure 6F-1. Height and Lateral Location of Signs - Typical Installations 666

Figure 6F-2. Methods of Mounting Signs Other Than on Posts 667

Figure 6F-3. Regulatory Signs in Temporary Traffic Control Zones 669

Figure 6F-4. Warning Signs and Plaques in Temporary Traffic Control Zones..... 675

Figure 6F-5. Exit Open and Closed and Detour Signs..... 680

Figure 6F-6. Advance Warning Arrow Board Display Specifications 691

Figure 6F-7. Channelizing Devices 692

Figure 6H-1. Work Beyond the Shoulder (TA-1) 729

Figure 6H-2. Blasting Zone (TA-2)..... 731

Figure 6H-3. Work on the Shoulders (TA-3) 733

Figure 6H-4. Short Duration or Mobile Operation on a Shoulder (TA-4)..... 735

Figure 6H-5. Shoulder Closure on a Freeway (TA-5) 737

Figure 6H-6. Shoulder Work with Minor Encroachment (TA-6)..... 739

Figure 6H-7. Road Closure with a Diversion (TA-7)..... 741

Figure 6H-8. Road Closure with an Off-Site Detour (TA-8) 743

Figure 6H-9. Overlapping Routes with a Detour (TA-9) 745

Figure 6H-10. Lane Closure on a Two-Lane Road Using Flaggers (TA-10)..... 747

Figure 6H-11. Lane Closure on a Two-Lane Road with Low Traffic Volumes (TA-11) 749

Figure 6H-12. Lane Closure on a Two-Lane Road Using Traffic Control Signals (TA-12)..... 751

Figure 6H-13. Temporary Road Closure (TA-13)..... 753

Figure 6H-14. Haul Road Crossing (TA-14)..... 755

Figure 6H-15. Work in the Center of a Road with Low Traffic Volumes (TA-15) 757

Figure 6H-16. Surveying Along the Center Line of a Road with Low Traffic Volumes (TA-16)..... 759

Figure 6H-17. Mobile Operations on a Two-Lane Road (TA-17)..... 761

Figure 6H-18. Lane Closure on a Minor Street (TA-18)..... 763

Figure 6H-19. Detour for One Travel Direction (TA-19) 765

Figure 6H-20. Detour for a Closed Street (TA-20) 767

Figure 6H-21. Lane Closure on the Near Side of an Intersection (TA-21) 769

Figure 6H-22. Right-Hand Lane Closure on the Far Side of an Intersection (TA-22)..... 771

Figure 6H-23. Left Lane Closure on the Far Side of an Intersection (TA-23) 773

Figure 6H-24. Half Road Closure on the Far Side of an Intersection (TA-24) 775

Figure 6H-25. Multiple Lane Closures at an Intersection (TA-25) 777

Figure 6H-26. Closure in the Center of an Intersection (TA-26) 779

Figure 6H-27. Closure at the Side of an Intersection (TA-27) 781

Figure 6H-28. Sidewalk Detour or Diversion (TA-28) 783

Figure 6H-29. Crosswalk Closures and Pedestrian Detours (TA-29) 785

Figure 6H-30.	Interior Lane Closure on a Multi-lane Street (TA-30).....	787
Figure 6H-31.	Lane Closures on a Street with Uneven Directional Volumes (TA-31)	789
Figure 6H-32.	Half Road Closure on a Multi-lane, High-Speed Highway (TA-32).....	791
Figure 6H-33.	Stationary Lane Closure on a Divided Highway (TA-33)	793
Figure 6H-34.	Lane Closure with a Temporary Traffic Barrier (TA-34).....	795
Figure 6H-35.	Mobile Operation on a Multi-lane Road (TA-35).....	797
Figure 6H-36.	Lane Shift on a Freeway (TA-36).....	799
Figure 6H-37.	Double Lane Closure on a Freeway (TA-37).....	801
Figure 6H-38.	Interior Lane Closure on a Freeway (TA-38)	803
Figure 6H-39.	Median Crossover on a Freeway (TA-39)	805
Figure 6H-40.	Median Crossover for an Entrance Ramp (TA-40).....	807
Figure 6H-41.	Median Crossover for an Exit Ramp (TA-41)	809
Figure 6H-42.	Work in Vicinity of Exit Ramp (TA-42)	811
Figure 6H-43.	Partial Exit Ramp Closure (TA-43)	813
Figure 6H-44.	Work in Vicinity of Entrance Ramp (TA-44).....	815
Figure 6H-45.	Temporary Reversible Lane Using Movable Barriers (TA-45).....	817
Figure 6H-46.	Work in Vicinity of Highway-Rail Grade-Crossing (TA-46).....	819
Figure 6I-1.	Examples of Traffic Incident Management Area Signs.....	822
Figure 7A-1.	Example of School Route Plan Map.....	827
Figure 7B-1.	School Area Signs.....	830
Figure 7B-2.	Example of Signing for a Higher Fines School Zone	836
Figure 7B-3.	Examples of Signing for a School Crossing Outside of a School Zone.....	837
Figure 7B-4.	Example of Signing for a School Zone with a School Crossing.....	838
Figure 7B-5.	In-Street Signs in School Areas	839
Figure 7C-1.	Two-Lane Pavement Marking of “SCHOOLI”	842
Figure 8B-1.	Regulatory Signs and Plaques for Grade Crossings.....	854
Figure 8B-2.	Crossbuck Assembly with a YIELD or STOP Sign on the Crossbuck Sign Support.....	855
Figure 8B-3.	Crossbuck Assembly with a YIELD or STOP Sign on a Separate Sign Support	856
Figure 8B-4.	Warning Signs and Plaques for Grade Crossings	860
Figure 8B-5.	Example of an Emergency Notification Sign	864
Figure 8B-6.	Example of Placement of Warning Signs and Pavement Markings at Highway-Rail Grade Crossings	867
Figure 8B-7.	Grade Crossing Pavement Markings.....	868
Figure 8B-8.	Example of Dynamic Envelope Pavement Markings at Grade Crossings.....	869
Figure 8B-9.	Examples of Light Rail Transit Vehicle Dynamic Envelope Markings for Mixed-Use Alignments.....	870
Figure 8C-1.	Composite Drawing of Active Traffic Control Devices for Grade Crossings Showing Clearances.....	874
Figure 8C-2.	Example of Location Plan for Flashing-Light Signals and Four-Quadrant Gates	878
Figure 8C-3.	Light Rail Transit Signals	884
Figure 8C-4.	Example of Flashing-Light Signal Assembly for Pedestrian Crossings	886
Figure 8C-5.	Example of a Shared Pedestrian/Roadway Gate.....	887
Figure 8C-6.	Example of a Separate Pedestrian Gate	887
Figure 8C-7.	Example of Placement of Pedestrian Gates	888
Figure 8C-8.	Example of Swing Gates.....	889
Figure 8C-9.	Example of Pedestrian Barriers at an Offset Grade Crossing	889
Figure 8C-10.	Example of Pedestrian Barrier Installation at an Offset Non-Intersection Grade Crossing	890
Figure 8D-1.	Example of Signing and Markings for a Pathway Grade Crossing	892
Figure 9B-1.	Sign Placement on Shared-Use Paths	898
Figure 9B-2.	Regulatory Signs and Plaques for Bicycle Facilities	901
Figure 9B-3.	Warning Signs and Plaques for Bicycle Facilities	905
Figure 9B-4.	Guide Signs and Plaques for Bicycle Facilities	907

Figure 9B-5. Example of Signing for the Beginning and End of a Designated Bicycle Route on a Shared-Use Path..... 909

Figure 9B-6. Example of Bicycle Guide Signing..... 910

Figure 9B-7. Examples of Signing and Markings for a Shared-Use Path Crossing..... 911

Figure 9B-8. Example of Mode-Specific Guide Signing on a Shared-Use Path..... 913

Figure 9C-1. Example of Intersection Pavement Markings - Designated Bicycle Lane with Left-Turn Area, Heavy Turn Volumes, Parking, One-Way Traffic, or Divided Highway.. 916

Figure 9C-2. Examples of Center Line Markings for Shared-Use Paths 917

Figure 9C-3. Word, Symbol, and Arrow Pavement Markings for Bicycle Lanes..... 918

Figure 9C-4. Example of Bicycle Lane Treatment at a Right Turn Only Lane 920

Figure 9C-5. Example of Bicycle Lane Treatment at Parking Lane into a Right Turn Only Lane..... 921

Figure 9C-6. Example of Pavement Markings for Bicycle Lanes on a Two-Way Street..... 922

Figure 9C-7. Bicycle Detector Pavement Marking 923

Figure 9C-8. Examples of Obstruction Pavement Markings..... 924

Figure 9C-9. Shared Lane Marking..... 924

TABLES

Table 1A-1. Acceptable Abbreviations 30

Table 1A-2. Abbreviations That Shall be Used Only on Portable Changeable Message Signs..... 31

Table 1A-3. Unacceptable Abbreviations 32

Table 2A-1. Illumination of Sign Elements 36

Table 2A-2. Retroreflection of Sign Elements 37

Table 2A-3. Minimum Maintained Retroreflectivity Levels 38

Table 2A-4. Use of Sign Shapes 40

Table 2A-5. Common Uses of Sign Colors..... 41

Table 2B-1. Regulatory Sign and Plaque Sizes..... 54

Table 2C-1. Categories of Warning Signs and Plaques 120

Table 2C-2. Warning Sign and Plaque Sizes 121

Table 2C-3. Minimum Size of Supplemental Warning Plaques 125

Table 2C-4. Guidelines for Advance Placement of Warning Signs..... 126

Table 2C-5. Horizontal Alignment Sign Selection 128

Table 2C-6. Typical Spacing of Chevron Alignment Signs on Horizontal Curves 130

Table 2D-1. Conventional Road Guide Sign Sizes 159

Table 2D-2. Recommended Minimum Letter Heights on Street Name Signs 185

Table 2E-1. Freeway or Expressway Guide Sign and Plaque Sizes 213

Table 2E-2. Signing Levels for Freeway and Expressway Guide Signs According to Interchange Classification..... 215

Table 2E-3. Minimum Element Sizes for Freeway and Expressway Guide Signs According to Signing Levels 216

Table 2F-1. Toll Road Sign and Plaque Minimum Sizes 266

Table 2G-1. Managed and Preferential Lanes Sign and Plaque Minimum Sizes..... 285

Table 2H-1. General Information Sign Sizes 326

Table 2I-1. General Service Sign and Plaque Sizes..... 335

Table 2J-1. Minimum Letter and Numeral Sizes for Specific Service Signs According to Sign Type 354

Table 2L-1. Example of Units of Information 367

Table 2M-1. Category Chart for Recreational and Cultural Interest Area Symbols..... 370

Table 3B-1. Minimum Passing Sight Distances for No-Passing Zone Markings 396

Table 3D-1. Standard Edge Line and Lane Line Markings for Preferential Lanes..... 465

Table 3F-1. Approximate Spacing for Delineators on Horizontal Curves 478

Table 4C-1. Warrant 1, Eight-Hour Vehicular Volume..... 496

Table 4C-2.	Warrant 9 Adjustment Factor for Daily Frequency of Rail Traffic	506
Table 4C-3.	Warrant 9, Adjustment Factor for Daily Frequency of Rail Traffic	507
Table 4C-4.	Warrant 9, Adjustment Factor for Percentage of Tractor-Trailer Trucks	507
Table 4D-1.	Recommended Minimum Number of Primary Signal Faces for Through Traffic on Approaches with Posted, Statutory, or 85 th -percentile Speed of 45 mph or Higher	522
Table 4D-2.	Minimum Sight Distance for Signal Visibility	523
Table 5A-1.	Sign and Plaque Sizes on Low-Volume Roads.....	603
Table 6C-1.	Recommended Advance Warning Sign Minimum Spacing	632
Table 6C-2.	Stopping Sight Distance as a Function of Speed	633
Table 6C-3.	Taper Length Criteria for Temporary Traffic Control Zones	635
Table 6C-4.	Formulas for Determining Taper Length	635
Table 6E-1.	Stopping Sight Distance as a Function of Speed	657
Table 6F-1.	Sizes of Temporary Traffic Control Signs	662
Table 6H-1.	Index to Typical Applications.....	725
Table 6H-2.	Meaning of Symbols on Typical Application Diagrams.....	726
Table 6H-3.	Meaning of Letter Codes on Typical Application Diagrams	726
Table 6H-4.	Formulas for Determining Taper Lengths	727
Table 7B-1.	School Area Sign and Plaque Sizes	829
Table 8B-1.	Sign Sizes for Grade Crossing Signs	852
Table 9B-1.	Bicycle Facility Sign and Plaque Minimum Sizes	899

OHIO MANUAL OF UNIFORM TRAFFIC CONTROL DEVICES

INTRODUCTION

Standard:

- 01 **As noted in Section 4511.01(QQ) of the Ohio Revised Code (ORC), traffic control devices shall mean:**

a flagger, sign, signal, marking, or other device used to regulate, warn, or guide traffic, placed on, over, or adjacent to a street, highway, private road open to public travel, pedestrian facility, or shared-use path by authority of a public agency or official having jurisdiction, or, in the case of a private road open to public travel, by authority of the private owner or private official having jurisdiction.

Support:

- 02 The “Ohio Manual of Uniform Traffic Control Devices” (OMUTCD) has been developed pursuant to Section 4511.09 of the ORC to establish standards for the use of traffic control devices in the State of Ohio. Sections 4511.10 and 4511.11 of the ORC address the responsibilities that ODOT, local highway authorities, and owners of private roads open to public travel have to place and maintain traffic control devices on all highways within their respective jurisdictions in conformance with the OMUTCD (see Appendix B2).

Standard:

- 03 **Any traffic control device design or application provision contained in this Manual shall be considered to be in the public domain. Traffic control devices contained in this Manual shall not be protected by a patent, trademark, or copyright, except for the Interstate Shield and any items owned by FHWA.**

Support:

- 04 Pictographs, as defined in Section 1A.13, are embedded in traffic control devices but the pictographs themselves are not considered traffic control devices for the purposes of Paragraph 4.

- 05 The need for uniform standards was recognized long ago. Ohio published its first recorded uniform traffic control standards manual in 1924, and subsequent editions and revisions of the Ohio Manual have in large part been updates to conform to changes in the national standards (see Table I-1). To encourage national uniformity, the American Association of State Highway Officials (AASHO), now known as the American Association of State Highway and Transportation Officials (AASHTO), published a manual for rural highways in 1927, and the National Conference on Street and Highway Safety (NCSHS) published a manual for urban streets in 1930. To meet the need for unification of the standards applicable to the different classes of road and street systems, a joint committee of AASHO and NCSHS developed and published the original edition of the national Manual on Uniform Traffic Control Devices (MUTCD) in 1935. That committee, now called the National Committee on Uniform Traffic Control Devices (NCUTCD), though changed from time to time in name, organization, and personnel, has been in continuous existence and has contributed to periodic revisions of the national Manual. However, since 1971 the FHWA has administered the national MUTCD.

Standard:

- 06 **The U.S. Secretary of Transportation, under authority granted by the Highway Safety Act of 1966, decreed that traffic control devices on all streets and highways open to public travel in accordance with 23 U.S.C. 109(d) and 402(a) in each State shall be in substantial conformance with the Standards issued or endorsed by the Federal Highway Administration (FHWA).**

Support:

- 07 Section 4511.09 of the Ohio Revised Code (see Appendix B2) requires the “Ohio Manual of Uniform Traffic Control Devices” to “correlate with, and so far as possible conform to” FHWA’s national MUTCD.

- 08 The Standard, Guidance, Option, and Support material described in the OMUTCD provide the transportation professional with the information needed to make appropriate decisions regarding the use of traffic control devices on streets, highways, bikeways and private roads open to public travel (see definition in Section 1A.13).

09 Throughout this Manual the headings Standard, Guidance, Option, and Support are used to classify the nature of the text that follows. Figures and tables, including the notes contained therein, supplement the text and might constitute a Standard, Guidance, Option, or Support. The user needs to refer to the appropriate text to classify the nature of the figure, table, or note contained therein.

Standard:

10 **When used in this Manual, the text headings of Standard, Guidance, Option, and Support shall be as defined in Paragraph 1 of Section 1A.13.**

Support:

11 Throughout this Manual dimensions, distances, etc. are provided in English units. Appendix D contains tables for converting each of the English unit numerical values that are used in this Manual to the equivalent Metric (International System of Units) values.

Standard:

12 **Metric legends shall not be used on traffic control signs.**

Guidance:

13 If Metric units are to be used in laying out distances or determining sizes of devices, such units should be specified on plan drawings and made known to those responsible for designing, installing, or maintaining traffic control devices.

14 Except when a specific numeral is required or recommended by the text of a Section of this Manual, numerals displayed on the images of devices in the figures that specify quantities such as times, distances, speed limits, and weights should be regarded as examples only. When installing any of these devices, the numerals should be appropriately altered to fit the specific situation.

Support:

15 The following information will be useful when reference is being made to a specific portion of text in this Manual.

16 There are nine Parts in this Manual and each Part is comprised of one or more Chapters. Each Chapter is comprised of one or more Sections. Parts are given a numerical identification, such as Part 2-Signs. Chapters are identified by the Part number and a letter, such as Chapter 2B-Regulatory Signs, Barricades, and Gates. Sections are identified by the Chapter number and letter followed by a decimal point and a number, such as Section 2B.03 - Size of Regulatory Signs.

17 Each Section is comprised of one or more paragraphs. The paragraphs are indented and are identified by a number. Paragraphs are counted from the beginning of each Section without regard to the intervening text headings (Standard, Guidance, Option, or Support). Some paragraphs have lettered or numbered items. As an example of how to cite this Manual, the phrase "Not less than 40 ft beyond the stop line" that appears in Section 4D.14 of this Manual would be referenced in writing as "Section 4D.15, P1, A.1," and would be verbally referenced as "Item A.1 of Paragraph 1 of Section 4D.14."

18 The MUTCD published by FHWA states that:

"In accordance with 23 CFR 655.603(b)(3), States or other Federal agencies that have their own MUTCDs or Supplements shall revise these MUTCDs or Supplements to be in substantial conformance with changes to the National MUTCD within 2 years of the effective date of the Final Rule for the changes. Substantial conformance of such State or other Federal agency MUTCDs or Supplements shall be as defined in 23 CFR 655.603(b)(1).

After the effective date of a new edition of the MUTCD or a revision thereto, or after the adoption thereof by the State, whichever occurs later, new or reconstructed devices installed shall be in compliance with the new edition or revision.

In cases involving Federal-aid projects for new highway or bikeway construction or reconstruction, the traffic control devices installed (temporary or permanent) shall be in conformance with the most recent edition of the National MUTCD before that highway is opened or re-opened to the public for unrestricted travel [23 CFR 655.603(d)(2) and (d)(3)].

Unless a particular device is no longer serviceable, non-compliant devices on existing highways and bikeways shall be brought into compliance with the current edition of the National MUTCD as part of the systematic upgrading of substandard traffic control devices (and installation of new required traffic control devices) required pursuant to the Highway Safety Program, 23 U.S.C. § 402(a). The FHWA has the authority to establish other target compliance dates for implementation of particular changes to the MUTCD [23 CFR 655.603(d)(1)].”

- 19 Target compliance dates established by the FHWA at the time of the 2009 MUTCD are shown in Table I-3. However, as of the time of printing of this edition of the OMUTCD, these FHWA compliance dates are under review. Further information on the current status of this review and a Final Rule on this subject, when published, are available from the FHWA’s website for the MUTCD at <http://mutcd.fhwa.dot.gov/>.

Standard

- 20 **Except as provided in Paragraph 21, when a non-compliant traffic control device is being replaced or refurbished because it is damaged, missing, or no longer serviceable for any reason, it shall be replaced with a compliant device.**

Option:

- 21 A damaged, missing, or otherwise non-serviceable device that is non-compliant may be replaced in kind at the time of this maintenance activity if engineering judgment indicates that:
- A. One compliant device in the midst of a series of adjacent non-compliant devices would be confusing to road users; and/or
 - B. The schedule for replacement of the whole series of non-compliant devices will result in achieving timely compliance with the OMUTCD.

Table I-1. Evolution of the OMUTCD

Edition	Name	Approval/Adopted	Effective Date
1924	Manual of Standard Signs and Marker		5/24
1934	Manual of Standard Signs, Markers, and Pavement Marking		7/34
1943	Ohio Manual of Uniform Traffic Control Devices		1943
1952	Ohio Manual of Uniform Traffic Control Devices		3/52
1956	Ohio Manual of Uniform Traffic Control Devices		4/56
1962	Ohio Manual of Uniform Traffic Control Devices, Supplement (Part 7 reprint) (Using Journal Entry system to record Director's "approval.")	Vol. 47: pg 885; dated 8/27/62	8/27/62
1963	Ohio Manual of Uniform Traffic Control Devices	Vol. 48: pg 770; dated 9/19/63 Vol. 52: pg 151; dated 3/3/67 Vol. 53: pg 108; dated 2/5/68 Vol. 54: pg 873; dated 9/15/69 Vol. 56: pg 174; dated 2/19/71	9/19/63 3/25/67 3/29/68 10/31/69 3/15/71
1972	Ohio Manual of Uniform Traffic Control Devices for Streets and Highways — transition period from 1963 Edition to 1972 Edition; there was an overlap during this period between the two manual editions. The 1975 revisions were distributed together on 7/1/1975.	Vol. 56: pg 997; dated 11/17/71 Vol. 57: pg 379; dated 4/13/72 Vol. 58: pg 179; dated 3/5/73 Vol. 58: pg 788; dated 8/3/73 Vol. 59: pg 1078; dated 11/1/74 Vol. 60: pg 311; dated 3/31/75 Vol. 60: pg 263; dated 3/13/75	1/3/72 5/31/72 4/25/73 9/10/73 11/1/74 3/31/75 7/1/75
1972	Ohio Manual of Uniform Traffic Control Devices The 1976 and both 1977 revisions were distributed together. The 1992 revisions were distributed together on 7/27/1992. (Journal Entries no longer used. Transmittal letter constitutes the Director's "approval.")	Vol. 61: pg 817; dated 8/11/76 Vol. 62: pg 739; dated 6/27/77 Vol. 62: pg 1081; dated 9/19/77 Vol. 64: pg 642; dated 6/27/79 Vol. 67: pg 752; dated 7/16/82 Vol. 71: pg 1085; dated 11/14/86 Vol. 75: pg 7; dated 5/22/90 Vol. 76: pg 3; dated 10/1/91 Vol. 77: pg 1; dated 7/7/92 Vol. 77: pg 1; dated 7/21/92 Vol. 79: pg 1; dated 6/6/94 Vol. 80: pg 14; dated 6/22/95 Vol. 81: pg 1; dated 9/10/96 Vol. 81: pg 1; dated 9/16/96 Adopted by Director 4/15/99	9/1/76 7/1/77 11/3/77 10/1/79 9/7/82 2/1/87 7/9/90 10/1/91 7/7/92 7/27/92 8/1/94 8/14/95 9/10/96 1/1/97 6/1/99
2003	Ohio Manual of Uniform Traffic Control Devices, 2003 Edition	8/1/03	9/1/03
2005	Ohio Manual of Uniform Traffic Control Devices, 2005 Edition Revision 1 Revision 2	12/1/05 December 23, 2009 March 18, 2011	12/22/05 1/15/10 4/15/11
2012	Ohio Manual of Uniform Traffic Control Devices, 2011 Edition	1/13/12	4/12/12

Table I-2. Revision Record for the 2011 Edition of the OMUTCD

Title	Date	Description	Effective Date
2012 Edition	January 13, 2012	New edition, updating the Manual to conform 2009 Edition of the national Manual on uniform Traffic Control Devices (published December 16, 2009), and to incorporate additional revisions. Part 1, General Provisions, Part 2, Signs, Part 3, Markings, Part 4, Signals, Part 5, Low-Volume Rural Roads, Part 6, Temporary Traffic Control, Part 7, Traffic Control for School Areas, and Part 9, Traffic Control for Bicycle Facilities have been revised. Part 8, Highway-Rail Grade Crossings and Part 10 Highway-Light Rail Transit Grade Crossings have been combined into a new Part 8, Traffic Control for Railroad and Light Rail Transit Grade Crossings. The Appendices have been updated and a new Appendix A2 has been added to provide metric conversion information.	April 12, 2012

Table I-3. FHWA's Target Compliance Dates for MUTCD Items (Sheet 1 of 3)
(As noted in Paragraph 19, information on the current status of a review of these Target Compliance Dates and a Final Rule on this subject, when published, are available from the FHWA's website for the MUTCD at <http://mutcd.fhwa.dot.gov/>.)

2009 MUTCD Section Number(s)	2009 MUTCD Section Title	Specific Provision	Compliance Date
2A.08	Minimum Retroreflectivity Levels	Implementation and continued use of an assessment or management method that is designed to maintain traffic sign retroreflectivity at or above the established minimum levels.	January 22, 2012 (c)
2A.08	Minimum Retroreflectivity Levels	Replacement of regulatory, warning, and post-mounted guide (except street name) signs that are identified using the assessment or management method as failing to meet the established minimum levels.	January 22, 2015 (c)
2A.08	Minimum Retroreflectivity Levels	Replacement of street name signs and overhead guide signs that are identified using the assessment or management method as failing to meet the established minimum levels.	January 22, 2018 (c)
2A.19	Lateral Offset	Crashworthiness of sign supports on roads with posted speed limit of 50 mph or higher	January 17, 2013 (a)
2B.03	Size of Regulatory Signs	Increased sign sizes and other 2003 MUTCD revisions to Table 2B-1 (*)	December 22, 2013 (b)
2B.09	YIELD Sign Applications	Changes in YIELD sign application criteria from the 1988 MUTCD to the 2003 MUTCD (*)	January 17, 2011 (a)
2B.10	STOP Sign or YIELD Sign Placement	Signs mounted on the back of STOP or YIELD signs should not obscure shape of STOP sign, with exception for DO NOT ENTER signs (2003 MUTCD Sections 2B.06 and 2B.10) (*)	December 22, 2013 (b)
2B.11	Yield Here To Pedestrians Signs and Stop Here For Pedestrians Signs (R1-5)	New Section 2B.11 in the 2003 MUTCD (*)	December 22, 2013 (b)
2B.13	Speed Limit Sign (R2-1)	Color of changeable message legend of YOUR SPEED legend	December 22, 2013 (b)
2B.26	Reversible Lane Control Signs (R3-9e through R3-9i)	Removal of the R3-9c and R3-9e signs that had been included in the 2000 MUTCD (2003 MUTCD Section 2B.25)	December 22, 2013 (b)
2B.40	ONE WAY Signs (R6-1, R6-2)	New requirement in the 2009 MUTCD for the number and locations of ONE WAY signs	December 31, 2019
2B.55	Photo Enforced Signs and Plaques (R10-18, R10-19P, R10-19aP)	New signs (2003 MUTCD Section 2B.46) (*)	December 22, 2013 (b)
2C.04	Size of Warning Signs	New sizes in the 2003 MUTCD for the W1 Series arrow signs, the W12-2a low clearance signs, the W7 Series runaway truck signs, and the W10-1 advance grade crossing sign (*)	December 22, 2013 (b)
2C.06 thru 2C.14	Horizontal Alignment Warning Signs	Revised requirements in the 2009 MUTCD regarding the use of various horizontal alignment signs	December 31, 2019
2C.13	Truck Rollover Warning Sign (W1-13)	New W1-13 sign (2003 MUTCD Section 2C.11)	December 22, 2013 (b)
2C.20	NARROW BRIDGE Sign (W5-2)	Elimination of symbol sign (2003 MUTCD Section 2C.16)	December 22, 2013 (b)
2C.30	PAVEMENT ENDS Sign (W8-3)	Removal of symbol sign (2000 MUTCD Section 2C.23)	January 17, 2011 (a)
2C.38	Reduced Speed Limit Ahead Signs (W3-5, W3-5a)	Removal of R2-5 Series Reduced Speed Ahead signs and use of W3-5 or W3-5a warning signs instead (2003 MUTCD Section 2C.30)	December 22, 2018 (b)
2C.40	Merge Signs (W4-1, W4-5)	New Entering Roadway Merge sign (W4-5) (2003 MUTCD Section 2C.31)	December 22, 2013 (b)
2C.41	Added Lane Signs (W4-3, W4-6)	New Entering Roadway Added Lane sign (W4-6) (2003 MUTCD Section 2C.32)	December 22, 2013 (b)
2C.42	Lane Ends Signs (W4-2, W9-1, W9-2)	New design of W4-2 sign (2003 MUTCD Section 2C.33)	December 22, 2013 (b)
2C.46	Intersection Warning Signs (W2-1 through W2-8)	New design of Circular Intersection (W2-6) sign (2003 MUTCD Section 2C.37)	December 22, 2013 (b)
2C.49	Vehicular Traffic Warning Signs	New symbol signs W11-1, W11-5, W11-5a, W11-6, W11-11, and W11-14 (2003 MUTCD Section 2C.40)	December 22, 2013 (b)

Table I-3. FHWA’s Target Compliance Dates for MUTCD Items (Sheet 2 of 3)
(As noted in Paragraph 19, information on the current status of a review of these Target Compliance Dates and a Final Rule on this subject, when published, are available from the FHWA’s website for the MUTCD at <http://mutcd.fhwa.dot.gov/>.)

2009 MUTCD Section Number(s)	2009 MUTCD Section Title	Specific Provision	Compliance Date
2C.50	Non-Vehicular Warning Signs	Elimination of crosswalk lines from crossing signs and use of diagonal downward pointing arrow (W16-7P) supplemental plaque if at the crossing (2003 MUTCD Section 2C.41)	January 17, 2011 (a)(b)
2C.61	PHOTO ENFORCED Plaque (W16-10P)	New plaque (2003 MUTCD Section 2C.53) (*)	December 22, 2013 (b)
2C.63	Object Marker Design and Placement Height	Width of stripes on Type 3 striped marker (2003 MUTCD Section 3C.01)	December 22, 2013 (b)
2D.43	Street Name Signs (D3-1 or D3-1a)	6-inch letter height for lettering on post-mounted Street Name signs (except on multi-lane streets with speed limits greater than 40 mph) (2000 MUTCD Section 2D.38)	January 9, 2012 (a)
2D.43	Street Name Signs (D3-1 or D3-1a)	8-inch letter height on post-mounted signs on multi-lane streets with speed limits greater than 40 mph and 12-inch letter height on overhead signs (2003 MUTCD Section 2D.38)	December 22, 2018 (b)
2D.44	Advance Street Name Signs (D3-2)	Requirements of new Section 2D.39 in the 2003 MUTCD	December 22, 2018 (b)
2D.45	Signing on Conventional Roads on Approaches to Interchanges	New requirement in the 2009 MUTCD for multi-lane approaches to interchanges to have guide signs to identify which direction of turn is to be made for access to each direction of the freeway or expressway	31-Dec-19
2E.31, 2E.33, and 2E.36	Plaques for Left-Hand Exits	New requirement in the 2009 MUTCD to use E1-5aP and E1-5bP plaques for left-hand exits	31-Dec-14
2G.01 through 2G.07	Regulatory Signs for Preferential Lanes	Requirements for regulatory signs for preferential lanes (2003 MUTCD Sections 2B.26 through 2B.28) (*)	December 22, 2013 (b)
2G.11 through 2G.15	Preferential Lane Guide Signs	New Section 2E.59 in the 2003 MUTCD (*)	December 22, 2013 (b)
2H.02, 2H.03	Reference Location Signs, Intermediate Reference Location Signs, and Enhanced Reference Location Signs	Location and spacing of Reference Location signs and design of Intermediate Reference Location signs (2003 MUTCD Sections 2D.46 and 2E.54)	December 22, 2013 (b)
2I.07	Radio Information Signing	New Channel 9 Monitored (D12-3) sign (2003 MUTCD Section 2D.45)	December 22, 2013 (b)
2I.08	TRAVEL INFO CALL 511 Signs (D12-5 and D12-5a)	New TRAVEL INFO CALL 511 Sign (D12-5) (2003 MUTCD Section 2D.45)	December 22, 2013 (b)
2J.05	Size of Lettering	Minimum height of letters and numerals on Specific Service signs (2000 MUTCD Section 2F.05)	January 17, 2011 (a)
2N.03	Evacuation Route Signs (EM-1 and EM-1a)	New design and size of EM-1 sign (2003 MUTCD Section 2I.03)	December 22, 2018 (b)
3B.04, 3B.05	White Longitudinal Pavement Markings	New requirement in the 2009 MUTCD for dotted lane lines for dropped lanes and for acceleration, deceleration, and auxiliary lanes	December 31, 2016 or resurfacing, whichever occurs first
3B.18	Crosswalk Markings	Gap between transverse lines of a crosswalk (2003 MUTCD Section 3B.17)	December 22, 2013 (b)
4D.01	General	Location of signalized midblock crosswalks	December 22, 2013 (b)
4D.26	Yellow Change and Red Clearance Intervals	New requirement in the 2009 MUTCD that durations of yellow change and red clearance intervals shall be determined using engineering practices	December 31, 2014, or when timing adjustments are made to the individual intersection and/or corridor, whichever occurs first
4D.31	Flashing Operation—Transition Out of Flashing Mode	Duration of steady red clearance interval in change from red-red flashing mode to steady (stop-and-go) mode (2003 MUTCD Section 4D.12)	December 22, 2013 (b)
4E.06	Pedestrian Intervals and Signal Phases	New requirement in the 2009 MUTCD that the pedestrian change interval shall not extend into the red clearance interval and shall be followed by a buffer interval of at least 3 seconds	December 31, 2014, or when timing adjustments are made to the individual intersection and/or corridor, whichever occurs first
4E.07	Countdown Pedestrian Signals	Pedestrian countdown hardware requirements	December 22, 2013 (b)

Table I-3. FHWA's Target Compliance Dates for MUTCD Items (Sheet 3 of 3)
(As noted in Paragraph 19, information on the current status of a review of these Target Compliance Dates and a Final Rule on this subject, when published, are available from the FHWA's website for the MUTCD at <http://mutcd.fhwa.dot.gov/>.)

2009 MUTCD Section Number(s)	2009 MUTCD Section Title	Specific Provision	Compliance Date
5C.05	NARROW BRIDGE Sign (W5-2)	Elimination of symbol sign	December 22, 2013 (b)
6D.03	Worker Safety Considerations	New requirement in the 2009 MUTCD that all workers within the right-of-way shall wear high-visibility apparel	December 31, 2011
6E.02	High-Visibility Safety Apparel	New requirement in the 2009 MUTCD that all flaggers within the right-of-way shall wear high-visibility apparel	December 31, 2011
7B.11	School Advance Crossing Assembly	Use of AHEAD (W16-9P) plaque or distance plaque (W16-2P or W16-2aP) (2000 MUTCD Section 7B.08)	January 17, 2011 (a)
7B.12	School Crossing Assembly	Elimination of crosswalk lines from crossing signs and use of diagonal downward pointing arrow (W16-7P) supplemental plaque (2000 MUTCD Sections 7B.08 and 7B.09)	January 17, 2011 (a)
7B.16	Reduced School Speed Limit Ahead Sign (S4-5, S4-5a)	Removal of R2-5 Series Reduced Speed Ahead signs and use of S4-5 or S4-5a warning signs instead (2003 MUTCD Section 7B.12)	December 22, 2013 (b)
7D.04	Uniform of Adult Crossing Guards	New requirement in the 2009 MUTCD for high-visibility apparel for adult crossing guards	December 31, 2011
8B.03	Grade Crossing (Crossbuck) Sign (R15-1) and Number of Tracks Plaque (R15-2P) at Active and Passive Grade Crossings	Retroreflective strip on crossbuck support (2000 MUTCD Section 8B.02) (*)	January 17, 2011 (a)
8B.04	Crossbuck Assemblies with YIELD or STOP Signs at Passive Grade Crossings	New requirement in the 2009 MUTCD for the use of STOP or YIELD signs with Crossbuck signs at passive grade crossings	December 31, 2011
8B.19 and 8C.02 through 8C.05	LRT Approaching-Activated Blank-Out Warning Sign, Flashing Light Signals, and Automatic Gates	Automatic gates, flashing-light signals, and blank-out signs at highway-LRT crossings per Part 10 of the 2000 MUTCD (*)	January 17, 2011 (a)
8C.09	Traffic Control Signals at or Near Highway-Rail Grade Crossings	Pre-signals (2003 MUTCD Section 8D.07)	December 22, 2013 (b)
8C.12	Grade Crossings Within or In Close Proximity to Circular Intersections	New requirement in the 2009 MUTCD for study of grade crossings near roundabouts	December 31, 2014
9B.18	Bicycle Warning and Combined Bicycle / Pedestrian Signs (W11-1 and W11-15)	Elimination of crosswalk lines from crossing signs and use of diagonal downward pointing arrow (W16-7P) supplemental plaque if at the crossing (2000 MUTCD Section 9B.15)	January 17, 2011 (a)

Notes: Unless otherwise noted, dates are as established in the Final Rule for the 2009 MUTCD.

- (a) Date established in the Final Rule for the 2000 MUTCD.
- (b) Date established in the final Rule for the 2003 MUTCD.
- (c) Date established in the Final Rule for Revision 2 of the 2003 MUTCD.
- (*) Provisions may have been revised in the 2009 MUTCD.

PART 1. GENERAL

CHAPTER 1A. GENERAL

Section 1A.01 Purpose of Traffic Control Devices

Support:

- 01 The purpose of traffic control devices, as well as the principles for their use, is to promote highway safety and efficiency by providing for the orderly movement
- 02 of all road users on streets, highways, bikeways and private roads open to public travel throughout the Nation.
- 03 Traffic control devices notify road users of regulations and provide warning and guidance needed for the uniform and efficient operation of all elements of the traffic stream in a manner intended to minimize the occurrences of crashes.

Standard:

- 04 **Traffic control devices or their supports shall not bear any advertising message or any other message that is not related to traffic control.**

Support:

- 05 Tourist-oriented directional signs and Specific Service signs are not considered advertising; rather, they are classified as motorist service signs.

Section 1A.02 Principles of Traffic Control Devices

Support:

- 01 This Manual contains the basic principles that govern the design and use of traffic control devices for all streets, highways, bikeways, and private roads open to public travel (see definition in Section 1A.13) regardless of type or class or the public agency, official, or owner having jurisdiction. This Manual's text specifies the restriction on the use of a device if it is intended for limited application or for a specific system. It is important that these principles be given primary consideration in the selection and application of each device.

Guidance:

- 02 *To be effective, a traffic control device should meet five basic requirements:*
- A. *Fulfill a need;*
 - B. *Command attention;*
 - C. *Convey a clear, simple meaning;*
 - D. *Command respect from road users; and*
 - E. *Give adequate time for proper response.*
- 03 *Design, placement, operation, maintenance, and uniformity are aspects that should be carefully considered in order to maximize the ability of a traffic control device to meet the five requirements listed in the previous paragraph. Vehicle speed should be carefully considered as an element that governs the design, operation, placement, and location of various traffic control devices.*

Support:

- 04 The definition of the word "speed" varies depending on its use. The definitions of specific speed terms are contained in Section 1A.13.

Guidance:

- 05 *The actions required of road users to obey regulatory devices are specified by the Ohio Revised Code (ORC), or in cases not covered by State statute, by local ordinance or resolution.*
- 06 *The proper use of traffic control devices should provide the reasonable and prudent road user with the information necessary to efficiently and lawfully use the streets, highways, pedestrian facilities, and bikeways.*

- 07 Uniformity of the meaning of traffic control devices is vital to their effectiveness. The meanings ascribed to devices in this Manual are in general accord with the publications mentioned in Section 1A.11.
- 08 Additional information regarding related sections of the Ohio Revised Code (ORC) is provided in Appendices B1 and B2.

Section 1A.03 Design of Traffic Control Devices

Guidance:

- 01 *Devices should be designed so that features such as size, shape, color, composition, lighting or retroreflection, and contrast are combined to draw attention to the devices; that size, shape, color, and simplicity of message combine to produce a clear meaning; that legibility and size combine with placement to permit adequate time for response; and that uniformity, size, legibility, and reasonableness of the message combine to command respect.*
- 02 *Aspects of a device's standard design should be modified only if there is a demonstrated need.*

Support:

- 03 *An example of modifying a device's design would be to modify the Combination Horizontal Alignment/Intersection (W1-10) sign to show intersecting side road on both sides rather than on just one side of the major road within the curve.*

Option:

- 04 With the exception of symbols and colors, minor modifications in the specific design elements of a device may be made provided the essential appearance characteristics are preserved.

Section 1A.04 Placement and Operation of Traffic Control Devices

Guidance:

- 01 *Placement of a traffic control device should be within the road user's view so that adequate visibility is provided. To aid in conveying the proper meaning, the traffic control device should be appropriately positioned with respect to the location, object, or situation to which it applies. The location and legibility of the traffic control device should be such that a road user has adequate time to make the proper response in both day and night conditions.*
- 02 *Traffic control devices should be placed and operated in a uniform and consistent manner.*
- 03 *Unnecessary traffic control devices should be removed. The fact that a device is in good physical condition should not be a basis for deferring needed removal or change.*

Section 1A.05 Maintenance of Traffic Control Devices

Guidance:

- 01 *Functional maintenance of traffic control devices should be used to determine if certain devices need to be changed to meet current traffic conditions.*
- 02 *Physical maintenance of traffic control devices should be performed to retain the legibility and visibility of the device, and to retain the proper functioning of the device.*

Support:

- 03 Clean, legible, properly mounted devices in good working condition command the respect of road users.

Section 1A.06 Uniformity of Traffic Control Devices

Support:

- 01 Uniformity of devices simplifies the task of the road user because it aids in recognition and understanding, thereby reducing perception/reaction time. Uniformity assists road users, law enforcement officers, and traffic courts by giving everyone the same interpretation. Uniformity assists public highway officials through efficiency in manufacture, installation, maintenance, and administration. Uniformity means treating similar situations in a similar way. The use of uniform traffic control devices does not, in itself, constitute uniformity. A standard device used where it is not appropriate is as objectionable as a nonstandard device; in fact, this

might be worse, because such misuse might result in disrespect at those locations where the device is needed and appropriate.

Section 1A.07 Responsibility for Traffic Control Devices

Support:

01 As noted in the Introduction, the “Ohio Manual of Uniform Traffic Control Devices” (OMUTCD) has been developed pursuant to Section 4511.09 of the ORC, to establish standards for the use of traffic control devices in the State of Ohio. ORC Section 4511.09 also requires that the “uniform system of traffic control devices” established in the OMUTCD “correlate with, and so far as possible conform to, the system approved by the federal highway administration.”

02 **23 CFR (Code of Federal Regulations) 655.603 requires that such State manuals be in substantial conformance with the National MUTCD, published by the Federal Highway Administration (FHWA).**

03 23 CFR 655.603 also states that traffic control devices on all streets, highways, bikeways, and private roads open to public travel in each State shall be in substantial conformance with standards issued or endorsed by the Federal Highway Administrator.

Standard:

04 **As provided in ORC Sections 4511.09, 4511.10 and 4511.11, the responsibility for the design, placement, operation, maintenance, and uniformity of traffic control devices shall rest with the public agency or the official having jurisdiction, or, in the case of private roads open to public travel, with the private owner or private official having jurisdiction (see Appendix B2).**

Support:

05 The Introduction of this Manual contain information regarding the meaning of substantial conformance and the applicability of the OMUTCD to private roads open to public travel.

06 The National MUTCD has been adopted by the National Park Service, the U.S. Forest Service, the U.S. Military Command, the Bureau of Indian Affairs, the Bureau of Land Management and the U.S. Fish and Wildlife Service.

Section 1A.08 Authority for Placement of Traffic Control Devices

Standard:

01 **Traffic control devices, advertisements, announcements, and other signs or messages within the highway right-of-way shall be placed only as authorized by a public authority or the official having jurisdiction, or, in the case of private roads open to public travel, by the private owner or private official having jurisdiction, for the purpose of regulating, warning, or guiding traffic.**

02 **When the public agency or the official having jurisdiction over a street or highway or, in the case of private roads open to public travel, by the private owner or private official having jurisdiction, has granted proper authority, others such as contractors and public utility companies shall be permitted to install temporary traffic control devices in temporary traffic control zones. Such traffic control devices shall conform with the Standards of this Manual.**

03 **All regulatory traffic control devices shall be supported by laws, ordinances, or regulations.**

Support:

04 Provisions of this Manual are based upon the concept that effective traffic control depends upon both appropriate application of the devices and reasonable enforcement of the regulations.

05 Although some highway design features, such as curbs, median barriers, guardrails, speed humps or tables, and textured pavement, have a significant impact on traffic operations and safety, they are not considered to be traffic control devices and provisions regarding their design and use are generally not included in this Manual.

06 Certain types of signs and other devices that do not have any traffic control purpose are sometimes placed within the highway right-of-way by or with the permission of the public agency or the official having jurisdiction over the street or highway. Most of these signs and other devices are not intended for use by road users in general, and their message is only important to individuals who have been instructed in their meanings.

These signs and other devices are not considered to be traffic control devices and provisions regarding their design and use are not included in this Manual. Among these signs and other devices are the following:

- A. Devices whose purpose is to assist highway maintenance personnel. Examples include markers to guide snowplow operators, devices that identify culvert and drop inlet locations, and devices that precisely identify highway locations for maintenance or mowing purposes.
- B. Devices whose purpose is to assist fire or law enforcement personnel. Examples include markers that identify fire hydrant locations, signs that identify fire or water district boundaries, speed measurement pavement markings, small indicator lights to assist in enforcement of red light violations, and photo enforcement systems.
- C. Devices whose purpose is to assist utility company personnel and highway contractors, such as markers that identify underground utility locations.
- D. Signs posting local non-traffic ordinances.
- E. Signs giving civic organization meeting information.

Standard:

- 07 **Signs and other devices that do not have any traffic control purpose that are placed within the highway right-of-way shall not be located where they will interfere with, or detract from, traffic control devices.**

Guidance:

- 08 *Any unauthorized traffic control device or other sign or message placed on the highway right-of-way by a private organization or individual constitutes a public nuisance and should be removed. All unofficial or nonessential traffic control devices, signs, or messages should be removed.*

Support:

- 09 Section 4511.16 of the Ohio Revised Code (ORC) prohibits the display of any unauthorized sign, signal, marking or device which interferes with the effectiveness of any official traffic control device and permits its removal by the authority having jurisdiction over the street or highway (see Appendix B2).

Section 1A.09 Engineering Study and Engineering Judgment

Support:

- 01 Definitions of an engineering study and engineering judgment are contained in Section 1A.13.

Standard:

- 02 **This Manual describes the application of traffic control devices, but shall not be a legal requirement for their installation.**

Guidance:

- 03 *The decision to use a particular device at a particular location should be made on the basis of either an engineering study or the application of engineering judgment. Thus, while this Manual provides Standards, Guidance, and Options for design and application of traffic control devices, this Manual should not be considered a substitute for engineering judgment.*

- 04 *Early in the process of location and design of roads and streets, engineers should coordinate such location and design with the design and placement of the traffic control devices to be used with such roads and streets.*

- 05 *Jurisdictions, or owners of private roads open to public travel, with responsibility for traffic control that do not have engineers on their staffs who are trained and/or experienced in traffic control devices should seek engineering assistance from others, such as the Ohio Department of Transportation (ODOT), their county, a nearby large city, or a traffic engineering consultant.*

Standard:

- 06 **If site-specific conditions lead agencies to determine that it is impossible or impractical to comply with a particular Standard and that they must deviate from the Standard at that location(s), the reasons for the deviation shall be fully documented.**

Support:

- 07 As part of the Federal-aid Program, each State is required to have a Local Technical Assistance Program (LTAP) and to provide technical assistance to local highway agencies. Requisite technical training in the

application of the principles of the OMUTCD is available from the State's Local Technical Assistance Program for needed engineering guidance and assistance.

Section 1A.10 Interpretations, Experimentations, Changes, and Interim Approvals

Standard:

- 01 **Design, application, and placement of traffic control devices other than those adopted in this Manual shall be prohibited unless the provisions of this Section are followed.**

Support:

- 02 Continuing advances in technology will produce changes in the highway, vehicle, and road user proficiency; therefore, portions of the system of traffic control devices in this Manual will require updating. In addition, unique situations often arise for device applications that might require interpretation or clarification of this Manual. It is important to have a procedure for recognizing these developments and for introducing new ideas and modifications into the system.

Standard:

- 03 **Except as provided in Paragraph 5, requests for any permission to experiment or interim approval shall be submitted electronically to the Federal Highway Administration (FHWA), Office of Transportation Operations, MUTCD team, at the following e-mail address: MUTCDofficialrequest@dot.gov. A copy of the request shall be sent to the of the Ohio Department of Transportation (ODOT), Office of Traffic Engineering (see page ii for contact information).**

- 04 **Requests for interpretations or changes shall be sent to the Ohio Department of Transportation (ODOT), Office of Traffic Engineering (see page ii for contact information).**

Option:

- 05 If electronic submission to FHWA is not possible, requests for permission to experiment or interim approval may instead be mailed to the Office of Transportation Operations, HOTP-1, Federal Highway Administration, 1200 New Jersey Avenue, SE, Washington, DC 20590.

Support:

- 06 Communications to FHWA regarding other MUTCD matters that are not related to official requests will receive quicker attention if they are submitted electronically to the MUTCD Team Leader or to the appropriate individual MUTCD team member. Their e-mail addresses are available through the links contained on the "Who's Who" page on the MUTCD website at <http://mutcd.fhwa.dot.gov/team.htm>.

Support:

- 07 An interpretation includes a consideration of the application and operation of standard traffic control devices, official meanings of standard traffic control devices, or the variations from standard device designs.

Guidance:

- 08 *Requests for an interpretation of this Manual should contain the following information:*

- A. *A concise statement of the interpretation being sought;*
- B. *A description of the condition that provoked the need for an interpretation;*
- C. *Any illustration that would be helpful to understand the request; and*
- D. *Any supporting research data that is pertinent to the item to be interpreted.*

Support:

- 09 Requests to experiment include consideration of field deployment for the purpose of testing or evaluating a new traffic control device, its application or manner of use, or a provision not specifically described in this Manual.

- 10 A request for permission to experiment will be considered only when submitted by the public agency or toll facility operator responsible for the operation of the road or street on which the experiment is to take place. For a private road open to public travel, the request will be considered only if it is submitted by the private owner or private official having jurisdiction.

- 11 A diagram indicating the process for experimenting with traffic control devices is shown in Figure 1A-1.

Guidance:

- 12 *The request to FHWA for permission to experiment should contain the following:*

- A. *A statement indicating the nature of the problem.*
- B. *A description of the proposed change to the traffic control device or application of the traffic control device, how it was developed, the manner in which it deviates from the standard, and how it is expected to be an improvement over existing standards.*
- C. *Any illustration that would be helpful to understand the traffic control device or use of the traffic control device.*
- D. *Any supporting data explaining how the traffic control device was developed, if it has been tried, in what ways it was found to be adequate or inadequate, and how this choice of device or application was derived.*
- E. *A legally binding statement certifying that the concept of the traffic control device is not protected by a patent or copyright. (An example of a traffic control device concept would be countdown pedestrian signals in general. Ordinarily an entire general concept would not be patented or copyrighted, but if it were it would not be acceptable for experimentation unless the patent or copyright owner signs a waiver of rights acceptable to the FHWA. An example of a patented or copyrighted specific device within the general concept of countdown pedestrian signals would be a manufacturer's design for its specific brand of countdown signal, including the design details of the housing or electronics that are unique to that manufacturer's product. As long as the general concept is not patented or copyrighted, it is acceptable for experimentation to incorporate the use of one or more patented devices of one or several manufacturers.)*
- F. *The time period and location(s) of the experiment.*
- G. *A detailed research or evaluation plan that must provide for close monitoring of the experimentation, especially in the early stages of its field implementation. The evaluation plan should include before and after studies as well as quantitative data describing the performance of the experimental device.*
- H. *An agreement to restore the site of the experiment to a condition that complies with the provisions of this Manual within 3 months following the end of the time period of the experiment. This agreement must also provide that the agency sponsoring the experimentation will terminate the experimentation at any time that it determines significant safety concerns are directly or indirectly attributable to the experimentation. The FHWA's Office of Transportation Operations has the right to terminate approval of the experimentation at any time if there is an indication of safety concerns. If, as a result of the experimentation, a request is made that the National Manual be changed to include the device or application being experimented with, the device or application will be permitted to remain in place until an official rulemaking action has occurred.*
- I. *An agreement to provide semiannual progress reports for the duration of the experimentation, and an agreement to provide a copy of the final results of the experimentation to the FHWA's Office of Transportation Operations within 3 months following completion of the experimentation. The FHWA's Office of Transportation Operations has the right to terminate approval of the experimentation if reports are not provided in accordance with this schedule.*

Support:

- 13 A change to the Manual includes consideration of a new device to replace a present standard device, an additional device to be added to the list of standard devices, or a revision to a traffic control device application or placement criteria.

Guidance:

- 14 *Requests for a change to this Manual should contain the following information:*
- A. *A statement indicating what change is proposed;*
 - B. *Any illustration that would be helpful to understand the request; and*
 - C. *Any supporting research data that is pertinent to the item to be reviewed.*

Support:

- 15 Interim approval by FHWA allows interim use, pending official rulemaking, of a new traffic control device, a revision to the application or manner of use of an existing traffic control device, or a provision not specifically described in this Manual. The FHWA issues an Interim Approval by official memorandum signed by the Associate Administrator for Operations and posts this memorandum on the MUTCD website. The

Figure 1A-1. Process for Requesting and Conducting Experimentations for New Traffic Control Devices

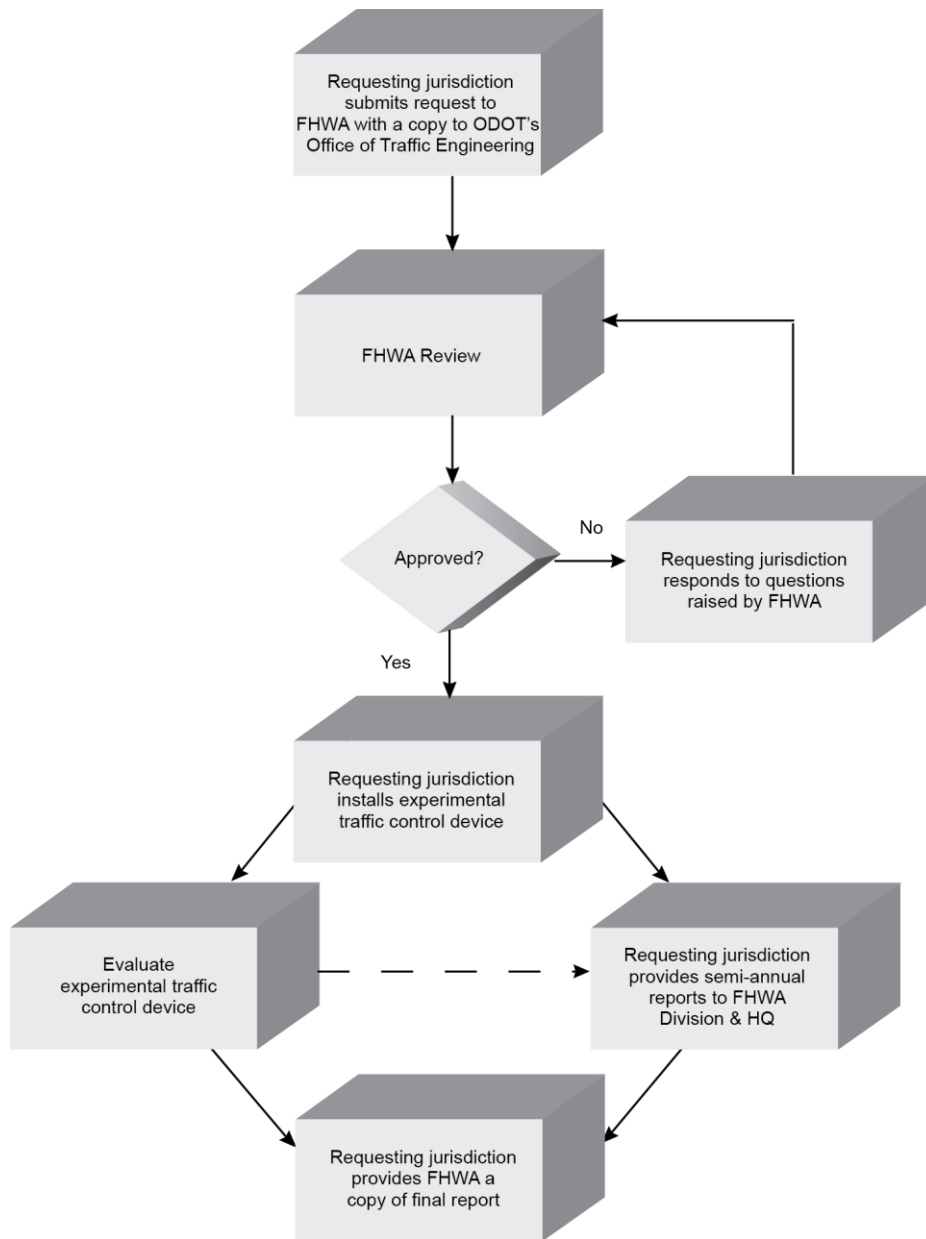

issuance by FHWA of an interim approval will typically result in the traffic control device or application being placed into the next scheduled rulemaking process for revisions to the National Manual.

16 Interim approval is considered based on the results of successful experimentation, results of analytical or laboratory studies, and/or review of non-U.S. experience with a traffic control device or application. Interim approval considerations include an assessment of relative risks, benefits, costs, impacts, and other factors.

17 Interim approval allows for optional use of a traffic control device or application and does not create a new mandate or recommendation for use. Interim approval includes conditions that jurisdictions agree to comply with in order to use the traffic control device or application until an official rulemaking action has occurred.

Standard:

18 **A jurisdiction, toll facility operator, or owner of a private road open to public travel that desires to use a traffic control device for which FHWA has issued an interim approval shall request permission from FHWA.**

Guidance:

- 19 *The request for permission to place a traffic control device under an interim approval should contain the following:*
- A. *A description of where the device will be used, such as a list of specific locations or highway segments or types of situations, or a statement of the intent to use the device jurisdiction-wide;*
 - B. *An agreement to abide by the specific conditions for use of the device as contained in the FHWA's interim approval document;*
 - C. *An agreement to maintain and continually update a list of locations where the device has been installed; and*
 1. *An agreement to: Restore the site(s) of the interim approval to a condition that complies with the provisions in this Manual within 3 months following the issuance of a Final Rule on this traffic control device; and*
 2. *Terminate use of the device or application installed under the interim approval at any time that it determines significant safety concerns are directly or indirectly attributable to the device or application. The FHWA's Office of Transportation Operations has the right to terminate the interim approval at any time if there is an indication of safety concerns.*

Option:

- 20 The Ohio Department of Transportation (ODOT) may submit a request for use of a device under interim approval for all jurisdictions in the State, as long as the request contains the information listed in Paragraph 19.

Guidance:

- 21 *A local jurisdiction, toll facility operator, or owner of a private road open to public travel using a traffic control device or application under an interim approval that was granted by FHWA either directly or on a statewide basis based on ODOT's request should inform ODOT of the locations of such use.*
- 22 *A local jurisdiction, toll facility operator, or owner of a private road open to public travel that is requesting permission to experiment or permission to use a device or application under an interim approval should first check for any State laws and/or directives covering the application of OMUTCD provisions that might exist.*

Option:

- 23 A device or application installed under an interim approval may remain in place, under the conditions established in the interim approval, until an official rulemaking action has occurred.

Support:

- 24 A diagram outlining FHWA's process for incorporating new traffic control devices into the National MUTCD is shown in Figure 1A-2.
- 25 For additional information concerning interpretations, experimentation, changes, or interim approvals, visit the MUTCD website at <http://mutcd.fhwa.dot.gov> or contact the ODOT, Office of Traffic Engineering at the addresses provided on page ii.

Section 1A.11 Relation to Other Publications**Standard:**

- 01 **To the extent that they are incorporated by specific reference, the latest editions of the following publications, or those editions specifically noted, shall be a part of this Manual: the current "Sign Designs and Markings Manual" (SDMM), published by ODOT; and "Color Specifications for Retroreflective Sign and Pavement Marking Materials" (appendix to subpart F of Part 655 of Title 23 of the Code of Federal Regulations).**

Support:

- 02 The "Sign Designs and Markings Manual" includes standard alphabets and symbols and arrows for signs and pavement markings.
- 03 For information about publications from the Federal Highway Administration, visit FHWA's MUTCD website at <http://mutcd.fhwa.dot.gov>, or write to the FHWA, 400 Seventh Street, SW, HOTO, Washington, DC 20590.

Figure 1A-2. Process for Incorporating New Traffic Control Devices into the National MUTCD

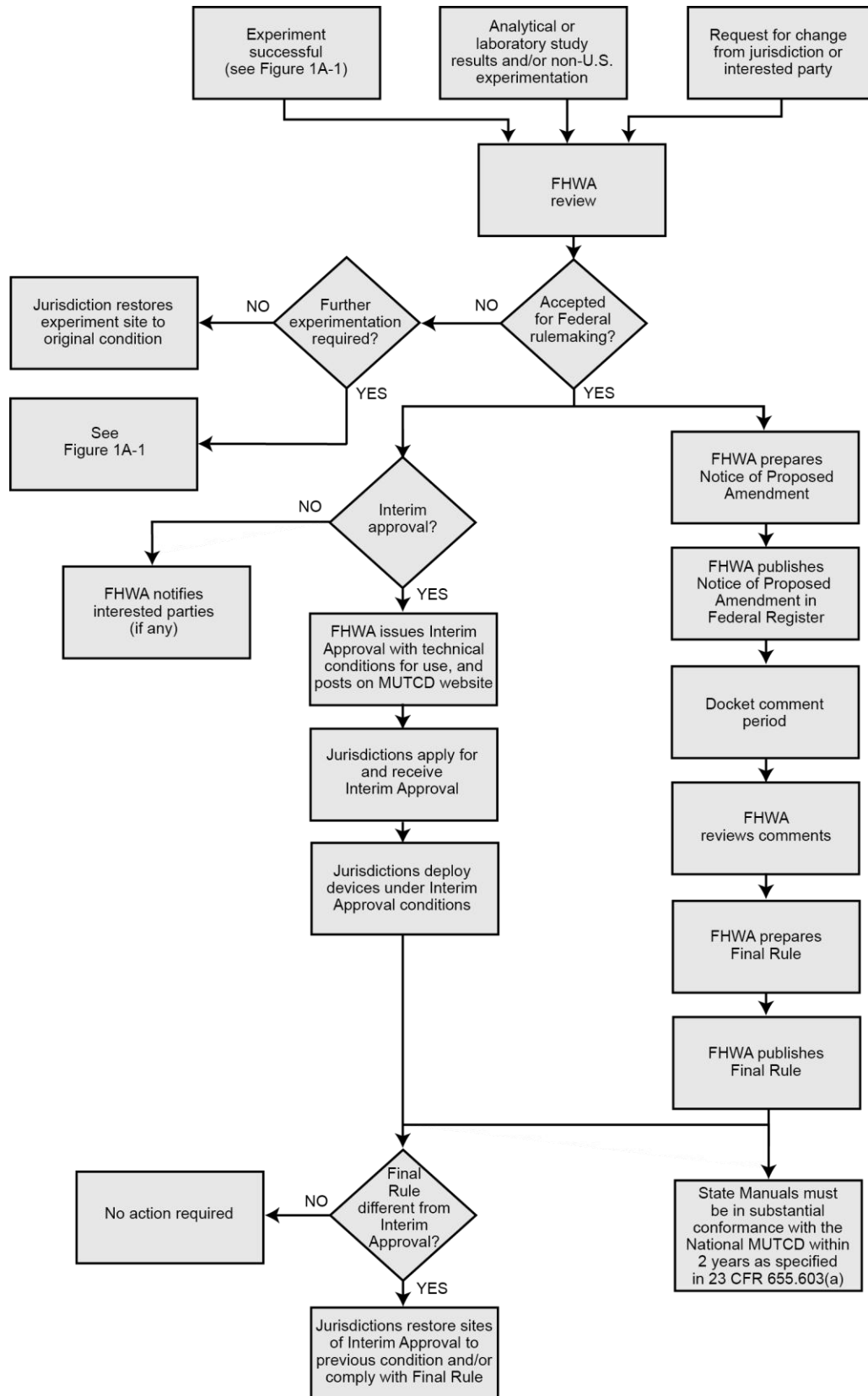

04 For information about publications published by the Ohio Department of Transportation (ODOT), visit the ODOT reference resource website at www.dot.state.oh.us/drrc, or write to the ODOT Office of Contracts, 1980 West Broad Street, P.O. Box 899, Columbus, Ohio 43216-0899.

05 Other publications that are useful sources of information with respect to use of this Manual are listed in this paragraph. See the Preface of this Manual for ordering information for the following publications (later editions might also be available as useful sources of information):

1. "AAA School Safety Patrol Operations Manual," 2006 Edition (American Automobile Association—AAA)
2. "A Policy on Geometric Design of Highways and Streets," 2004 Edition (American Association of State Highway and Transportation Officials—AASHTO)
3. "Guide for the Development of Bicycle Facilities," 1999 Edition (AASHTO)
4. "Guide for the Planning, Design, and Operation of Pedestrian Facilities," 2004 Edition (AASHTO)
5. "Guide to Metric Conversion," 1993 Edition (AASHTO)
6. "Guidelines for the Selection of Supplemental Guide Signs for Traffic Generators Adjacent to Freeways," 4th Edition/Guide Signs, Part II: Guidelines for Airport Guide Signing/Guide Signs, Part III: List of Control Cities for Use in Guide Signs on Interstate Highways," Item Code: GSGLC-4, 2001 Edition (AASHTO)
7. "Roadside Design Guide," 2006 Edition (AASHTO)
8. "Standard Specifications for Movable Highway Bridges," 1988 Edition (AASHTO)
9. "Traffic Engineering Metric Conversion Folders—Addendum to the Guide to Metric Conversion," 1993 Edition (AASHTO)
10. "2009 AREMA Communications & Signals Manual," (American Railway Engineering & Maintenance-of-Way Association—AREMA)
11. "Changeable Message Sign Operation and Messaging Handbook (FHWA-OP-03-070)," 2004 Edition (Federal Highway Administration—FHWA)
12. "Designing Sidewalks and Trails for Access—Part 2—Best Practices Design Guide (FHWA-EP-01-027)," 2001 Edition (FHWA)
13. "Federal-Aid Highway Program Guidance on High Occupancy Vehicle (HOV) Lanes," 2001 (FHWA)
14. "Maintaining Traffic Sign Retroreflectivity," 2007 Edition (FHWA)
15. "Railroad-Highway Grade Crossing Handbook—Revised Second Edition (FHWA-SA-07-010)," 2007 Edition (FHWA)
16. "Ramp Management and Control Handbook (FHWA-HOP-06-001)," 2006 Edition (FHWA)
17. "Roundabouts-An Informational Guide (FHWA-RD-00-067)," 2000 Edition (FHWA)
18. "Signal Timing Manual (FHWA-HOP-08-024)," 2008 Edition (FHWA)
19. "Signalized Intersections: an Informational Guide (FHWA-HRT-04-091)," 2004 Edition (FHWA)
20. "Travel Better, Travel Longer: A Pocket Guide to Improving Traffic Control and Mobility for Our Older Population (FHWA-OP-03-098)," 2003 Edition (FHWA)
21. "Practice for Roadway Lighting," RP-8, 2001 (Illuminating Engineering Society—IES)
22. "Safety Guide for the Prevention of Radio Frequency Radiation Hazards in the Use of Commercial Electric Detonators (Blasting Caps)," Safety Library Publication No. 20, July 2001 Edition (Institute of Makers of Explosives)
23. "American National Standard for High-Visibility Public Safety Vests," (ANSI/ISEA 207-2006), 2006 Edition (International Safety Equipment Association—ISEA)
24. "American National Standard for High-Visibility Safety Apparel and Headwear," (ANSI/ISEA 107-2004), 2004 Edition (ISEA)
25. "Manual of Traffic Signal Design," 1998 Edition (Institute of Transportation Engineers—ITE)
26. "Manual of Transportation Engineering Studies," 1994 Edition (ITE)
27. "Pedestrian Traffic Control Signal Indications," Part 1—1985 Edition; Part 2 (LED Pedestrian Traffic Signal Modules)—2004 Edition (ITE)
28. "Preemption of Traffic Signals Near Railroad Crossings," 2006 Edition (ITE)
29. "Purchase Specification for Flashing and Steady Burn Warning Lights," 1981 Edition (ITE)
30. "Traffic Control Devices Handbook," 2001 Edition (ITE)
31. "Traffic Detector Handbook," 1991 Edition (ITE)
32. "Traffic Engineering Handbook," 2009 Edition (ITE)

33. "Traffic Signal Lamps," 1980 Edition (ITE)
34. "Vehicle Traffic Control Signal Heads," Part 1—1985 Edition; Part 2 (LED Circular Signal Supplement)—2005 Edition; Part 3 (LED Vehicular Arrow Traffic Signal Supplement)—2004 Edition (ITE)
35. "Uniform Vehicle Code (UVC) and Model Traffic Ordinance," 2000 Edition (National Committee on Uniform Traffic Laws and Ordinances—NCUTLO)
36. "NEMA Standards Publication TS 4-2005 Hardware Standards for Dynamic Message Signs (DMS) With NTCIP Requirements," 2005 Edition (National Electrical Manufacturers Association—NEMA)
37. "Occupational Safety and Health Administration Regulations (Standards - 29 CFR), General Safety and Health Provisions - 1926.20," amended June 30, 1993 (Occupational Safety and Health Administration—OSHA)
38. "Accessible Pedestrian Signals—A Guide to Best Practices (NCHRP Web-Only Document 117A)," 2008 Edition (Transportation Research Board—TRB)
39. "Guidelines for Accessible Pedestrian Signals (NCHRP Web-Only Document 117B)," 2008 Edition (TRB)
40. "Highway Capacity Manual," 2000 Edition (TRB)
41. "Recommended Procedures for the Safety Performance Evaluation of Highway Features," (NCHRP Report 350), 1993 Edition (TRB)
42. "The Americans with Disabilities Act Accessibility Guidelines for Buildings and Facilities (ADAAG)," July 1998 Edition (The U.S. Access Board)
43. "Ohio Revised Code"
44. "Traffic Engineering Manual," current Edition (ODOT)
45. "Manual on Uniform Traffic Control Devices," 2009 Edition (FHWA)
46. "Location & Design Manual, Volume One – Roadway Design," current Edition (ODOT)
47. "Manual for Assessing Safety Hardware" (AASHTO)

Section 1A.12 Color Code

Support:

- 01 The following color code establishes general meanings for 11 colors of a total of 13 colors that have been identified as being appropriate for use in conveying traffic control information. Tolerance limits for each color are contained in 23 CFR Part 655, Appendix to Subpart F and are available at the Federal Highway Administration's MUTCD website at <http://mutcd.fhwa.dot.gov> or by writing to the FHWA, Office of Safety Research and Development (HRD-T-301), 6300 Georgetown Pike, McLean, VA 22101.
- 02 The two colors for which general meanings have not yet been assigned are being reserved for future applications that will be determined only by FHWA after consultation with the States, the engineering community, and the general public. The meanings described in this Section are of a general nature. More specific assignments of colors are given in the individual Parts of this Manual relating to each class of devices.

Standard:

- 03 **The general meaning of the 13 colors shall be as follows:**
 - A. Black—regulation**
 - B. Blue—road user services guidance, tourist information, and evacuation route**
 - C. Brown—recreational and cultural interest area guidance**
 - D. Coral—unassigned**
 - E. Fluorescent Pink—incident management**
 - F. Fluorescent Yellow-Green—pedestrian warning, bicycle warning, playground warning, school bus and school warning**
 - G. Green—indicated movements permitted, direction guidance**
 - H. Light Blue—unassigned**
 - I. Orange—temporary traffic control**
 - J. Purple—lanes restricted to use only by vehicles with registered electronic toll collection (ETC) accounts**
 - K. Red—stop or prohibition**
 - L. White—regulation**

M. Yellow—warning

Section 1A.13 Definitions of Headings, Words and Phrases in This Manual

Standard:

01 When used in this Manual, the text headings of Standard, Guidance, Option, and Support shall be defined as follows:

- A. **Standard**—a statement of required, mandatory, or specifically prohibitive practice regarding a traffic control device. All Standard statements are labeled, and the text appears in bold type. The verb “shall” is typically used. The verbs “should” and “may” are not used in Standard statements. Standard statements are sometimes modified by Options. Standard statements shall not be modified or compromised based on engineering judgment or engineering study.
- B. **Guidance**—a statement of recommended, but not mandatory, practice in typical situations, with deviations allowed if engineering judgment or engineering study indicates the deviation to be appropriate. All Guidance statements are labeled, and the text appears in unbold type. The verb “should” is typically used. The verbs “shall” and “may” are not used in Guidance statements. Guidance statements are sometimes modified by Options.
- C. **Option**—a statement of practice that is a permissive condition and carries no requirement or recommendation. Option statements contain allowable modifications to a Standard or Guidance statement. All Option statements are labeled, and the text appears in unbold type. The verb “may” is typically used. The verbs “shall” and “should” are not used in Option statements.
- D. **Support**—an informational statement that does not convey any degree of mandate, recommendation, authorization, prohibition, or enforceable condition. Support statements are labeled, and the text appears in unbold type. The verbs “shall,” “should,” and “may” are not used in Support statements.

02 Unless otherwise defined in this Section, or in other Parts of this Manual, words or phrases shall have the meaning(s) as defined in the most recent editions of the “AASHTO Transportation Glossary (Highway Definitions),” and other publications mentioned in Section 1A.11.

03 The following words and phrases, when used in this Manual, shall have the following meanings:

- 1. **Accessible Pedestrian Signal**—a device that communicates information about pedestrian signal timing in non-visual format such as audible tones, speech messages, and/or vibrating surfaces.
- 2. **Accessible Pedestrian Signal Detector**—a device designated to assist the pedestrian who has visual or physical disabilities in activating the pedestrian phase.
- 3. **Active Grade Crossing Warning System**—the flashing-light signals, with or without warning gates, together with the necessary control equipment used to inform road users of the approach or presence of rail traffic at grade crossings.
- 4. **Actuated Operation**—a type of traffic control signal operation in which some or all signal phases are operated on the basis of actuation.
- 5. **Actuation**—initiation of a change in or extension of a traffic signal phase through the operation of any type of detector.
- 6. **Advance Preemption**—the notification of approaching rail traffic that is forwarded to the highway traffic signal controller unit or assembly by the railroad or light rail transit equipment in advance of the activation of the railroad or light rail transit warning devices.
- 7. **Advance Preemption Time**—the period of time that is the difference between the required maximum highway traffic signal preemption time and the activation of the railroad or light rail transit warning devices.
- 8. **Advisory Speed**—a recommended speed for all vehicles operating on a section of highway and based on the highway design, operating characteristics, and conditions.
- 9. **Alley**—“a street or highway intended to provide access to the rear or side of lots or buildings in urban districts and not intended for the purpose of through vehicular traffic, and includes any street or highway that has been declared an “alley” by the legislative authority of the municipal corporation in which such street or highway is located.” [4511.01(XX), ORC]

10. **Altered Speed Zone**—a speed limit, other than a statutory speed limit, that is based upon an engineering study.
11. **Approach**—all lanes of traffic moving towards an intersection or a midblock location from one direction, including any adjacent parking lane(s).
12. **Arterial Highway (Street)**—“any United States or state numbered route, controlled access highway, or other major radial or circumferential street or highway designated by local authorities within their respective jurisdictions as part of a major arterial system of streets or highways.” [4511.01(CCC), ORC]
13. **Attended Lane (Manual Lane)**—a toll lane adjacent to a toll booth occupied by a human toll collector who makes change, issues receipts, and perform other toll-related functions. Attended lanes at toll plazas typically require vehicles to stop to pay the toll.
14. **Automatic Lane**—see Exact Change Lane.
15. **Average Annual Daily Traffic (AADT)**—the total volume of traffic passing a point or segment of a highway facility in both directions for one year divided by the number of days in the year. Normally, periodic daily traffic volumes are adjusted for hours of the day counted, days of the week, and seasons of the year to arrive at average annual daily traffic.
16. **Average Daily Traffic (ADT)**—the average 24 hour volume, being the total volume during a stated period divided by the number of days in that period. Normally, this would be periodic daily traffic volumes over several days, not adjusted for days of the week or seasons of the year.
17. **Average Day**—a day representing traffic volumes normally and repeatedly found at a location, typically a weekday when volumes are influenced by employment or a weekend day when volumes are influenced by entertainment or recreation.
18. **Backplate**—see Signal Backplate.
19. **Barrier-Separated Lane**—a preferential lane or other special purpose lane that is separated from the adjacent general-purpose lane(s) by a physical barrier.
20. **Beacon**—“a highway traffic signal with one or more signal sections that operate in a flashing mode.” [4511.01(KKK), ORC]
21. **Bicycle**—“every device, other than a tricycle designed solely for use as a play vehicle by a child, propelled solely by human power upon which any person may ride having two tandem wheels, or one wheel in the front and two wheels in the rear, or two wheels in the front and one wheel in the rear, any of which is more than fourteen inches in diameter.” [4511.01(G), ORC]
22. **Bicycle Facilities**—a general term denoting improvements and provisions that accommodate or encourage bicycling, including parking and storage facilities, and shared roadways not specifically defined for bicycle use.
23. **Bicycle Lane**—a portion of a roadway that has been designated for preferential or exclusive use by bicyclists by pavement markings and, if used, signs.
24. **Bikeway**—a generic term for any road, street, path, or way that in some manner is specifically designated for bicycle travel, regardless of whether such facilities are designated for the exclusive use of bicycles or are to be shared with other transportation modes.
25. **Buffer-Separated Lane**—a preferential lane or other special purpose lane that is separated from the adjacent general-purpose lane(s) by a pattern of standard longitudinal pavement markings that is wider than a normal or wide lane line marking. The buffer area might include rumble strips, textured pavement, or channelizing devices such as tubular markers or traversable curbs, but does not include a physical barrier.
26. **Cantilevered Signal Structure**—a structure, also referred to as a mast arm, that is rigidly attached to a vertical pole and is used to provide overhead support of highway traffic signal faces or grade crossing signal units.
27. **Center Line Markings**—the yellow pavement marking line(s) that delineates the separation of traffic lanes that have opposite directions of travel on a roadway. These markings need not be at the geometrical center of the pavement.
28. **Changeable Message Sign**—a sign that is capable of displaying more than one message (one of which might be a “blank” display), changeable manually, by remote control, or by automatic control. Electronic-display changeable message signs are referred to as Dynamic Message Signs in the National Intelligent Transportation Systems (ITS) Architecture and are referred

to as **Variable Message Signs in the National Electrical Manufacturers Association (NEMA) standards publication.**

29. **Channelizing Line Markings**—a wide or double solid white line used to form islands where traffic in the same direction of travel is permitted on both sides of the island.
30. **Circular Intersection**—an intersection that has an island, generally circular in design, located in the center of the intersection where traffic passes to the right of the island. Circular intersections include roundabouts, rotaries, and traffic circles.
31. **Circulatory Roadway**—the roadway within a circular intersection on which traffic travels in a counterclockwise direction around an island in the center of the circular intersection.
32. **Clear Storage Distance**— when used in Part 8, the distance available for vehicle storage measured between 6 feet from the rail nearest the intersection to the intersection stop line or the normal stopping point on the highway. At skewed grade crossings and intersections, the 6-foot distance shall be measured perpendicular to the nearest rail either along the center line or edge line of the highway, as appropriate, to obtain the shorter distance. Where exit gates are used, the distance available for vehicle storage is measured from the point where the rear of the vehicle would be clear of the exit gate arm. In cases where the exit gate arm is parallel to the track(s) and is not perpendicular to the highway, the distance is measured either along the center line or edge line of the highway, as appropriate, to obtain the shorter distance.
33. **Clear Zone**—the total roadside border area, starting at the edge of the traveled way, that is available for an errant driver to stop or regain control of a vehicle. This area might consist of a shoulder, a recoverable slope, and/or a non-recoverable, traversable slope with a clear run-out area at its toe.
34. **Collector Highway**—a term denoting a highway that in rural areas connects small towns and local highways to arterial highways, and in urban areas provides land access and traffic circulation within residential, commercial, and business areas and connects local highways to the arterial highways.
35. **Concurrent Flow Preferential Lane**—a preferential lane that is operated in the same direction as the adjacent mixed flow lanes, separated from the adjacent general-purpose freeway lanes by a standard lane stripe, painted buffer, or barrier.
36. **Conflict Monitor**—a device used to detect and respond to improper or conflicting signal indications and improper operating voltages in a traffic controller assembly.
37. **Constant Warning Time Detection**—a means of detecting rail traffic that provides relatively uniform warning time for the approach of trains or light rail transit traffic that are not accelerating or decelerating after being detected.
38. **Contiguous Lane**—a lane, preferential or otherwise, that is separated from the adjacent lane(s) only by a normal or wide lane line marking.
39. **Contrast Ratio**—see **Luminance Contrast**.
40. **Controller Assembly**—a complete electrical device mounted in a cabinet for controlling the operation of a highway traffic signal.
41. **Controller Unit**—that part of a controller assembly that is devoted to the selection and timing of the display of signal indications.
42. **Conventional Road**—a street or highway other than a low-volume road (as defined in Section 5A.01), expressway, or freeway.
43. **Counter-Flow Lane**—a lane operating in a direction opposite to the normal flow of traffic designated for peak direction of travel during at least a portion of the day. Counter-flow lanes are usually separated from the off-peak direction lanes by tubular markers or other flexible channelizing devices, temporary lane separators, or moveable or permanent barrier.
44. **Crashworthy**—a characteristic of a roadside appurtenance that has been successfully crash tested in accordance with a national standard such as the National Cooperative Highway Research Program Report 350, “Recommended Procedures for the Safety Performance Evaluation of Highway Features,” or the “Manual for Assessing Safety Hardware” (MASH).
45. **Crosswalk**—“means:
 - (1) That part of a roadway at intersections ordinarily included within the real or projected prolongation of property lines and curb lines or, in the absence of curbs, the edges of the traversable roadway;

- (2) Any portion of a roadway at an intersection or elsewhere, distinctly indicated for pedestrian crossing by lines or other markings on the surface;**
- (3) Notwithstanding divisions (LL)(1) and (2) of this section, there shall not be a crosswalk where local authorities have placed signs indicating no crossing.” [4511.01(LL), ORC]**
- 46. Crosswalk Lines—white pavement marking lines that identify a crosswalk.**
- 47. Cycle Length—the time required for one complete sequence of signal indications.**
- 48. Dark Mode—the lack of all signal indications at a signalized location. (The dark mode is most commonly associated with power failures, ramp meters, hybrid beacons, beacons, and some movable bridge signals.)**
- 49. Delineator—a retroreflective device mounted on the roadway surface or at the side of the roadway in a series to indicate the alignment of the roadway, especially at night or in adverse weather.**
- 50. Design Vehicle—the longest vehicle permitted by statute of the road authority (State or other) on that roadway.**
- 51. Designated Bicycle Route—a system of bikeways designated by the jurisdiction having authority with appropriate directional and informational route signs, with or without specific bicycle route numbers.**
- 52. Detectable—having a continuous edge within 6 inches of the surface so that pedestrians who have visual disabilities can sense its presence and receive usable guidance information.**
- 53. Detector—a device used for determining the presence or passage of vehicles or pedestrians.**
- 54. Downstream—a term that refers to a location that is encountered by traffic subsequent to an upstream location as it flows in an “upstream to downstream” direction. For example, “the downstream end of a lane line separating the turn lane from a through lane on the approach to an intersection” is the end of the lane line that is closest to the intersection.**
- 55. Driver (or Operator)—“every person who drives or is in actual physical control of a vehicle, trackless trolley, or streetcar.” [4511.01 (Y), ORC]**
- 56. Dropped Lane—a through lane that becomes a mandatory turn lane on a conventional roadway, or a through lane that becomes a mandatory exit lane on a freeway or expressway. The end of an acceleration lane and reductions in the number of through lanes that do not involve a mandatory turn or exit are not considered dropped lanes.**
- 57. Dual-Arrow Signal Section—a type of signal section designed to include both a yellow arrow and a green arrow.**
- 58. Dynamic Envelope—the clearance required for light rail transit traffic or a train and its cargo overhang due to any combination of loading, lateral motion, or suspension failure (see Figure 8B-8).**
- 59. Dynamic Exit Gate Operating Mode—a mode of operation where the exit gate operation is based on the presence of vehicles within the minimum track clearance distance.**
- 60. Edge Line Markings—white or yellow pavement marking lines that delineate the right or left edge(s) of a traveled way.**
- 61. Electronic Toll Collection (ETC)—a system for automated collection of tolls from moving or stopped vehicles through wireless technologies such as radio-frequency communication or optical scanning. ETC systems are classified as one of the following: (1) systems that require users to have registered toll accounts, with the use of equipment inside or on the exterior of vehicles, such as a transponder or barcode decal, that communicates with or is detected by roadside or overhead receiving equipment, or with the use of license plate optical scanning, to automatically deduct the toll from the registered user account, or (2) systems that do not require users to have registered toll accounts because vehicle license plates are optically scanned and invoices for the toll amount are sent through postal mail to the address of the vehicle owner.**
- 62. Electronic Toll Collection (ETC) Account Only Lane—a non-attended toll lane that is restricted to use only by vehicles with a registered toll payment account.**
- 63. Emergency-Vehicle Hybrid Beacon—a special type of hybrid beacon used to warn and control traffic at an unsignalized location to assist authorized emergency vehicles in entering or crossing a street or highway.**
- 64. Emergency-Vehicle Traffic Control Signal—a special traffic control signal that assigns the right-of-way to an authorized emergency vehicle.**

65. **End-of-Roadway Marker**—a device used to warn and alert road users of the end of a roadway in other than temporary traffic control zones.
66. **Engineering Judgment**—the evaluation of available pertinent information, and the application of appropriate principles, provisions, and practices as contained in this Manual and other sources, for the purpose of deciding upon the applicability, design, operation, or installation of a traffic control device. Engineering judgment shall be exercised by an engineer, or by an individual working under the supervision of an engineer, through the application of procedures and criteria established by the engineer. Documentation of engineering judgment is not required.
67. **Engineering Study**—the comprehensive analysis and evaluation of available pertinent information, and the application of appropriate principles, provisions, and practices as contained in this Manual and other sources, for the purpose of deciding upon the applicability, design, operation, or installation of a traffic control device. An engineering study shall be performed by an engineer, or by an individual working under the supervision of an engineer, through the application of procedures and criteria established by the engineer. An engineering study shall be documented.
68. **Entrance Gate**—an automatic gate that can be lowered across the lanes approaching a grade crossing to block road users from entering the grade crossing.
69. **Exact Change Lane (Automatic Lane)**—a non-attended toll lane that has a receptacle into which road users deposit coins totaling the exact amount of the toll. Exact Change lanes at toll plazas typically require vehicles to stop to pay the toll.
70. **Exit Gate**—an automatic gate that can be lowered across the lanes departing a grade crossing to block road users from entering the grade crossing by driving in the opposing traffic lanes.
71. **Exit Gate Clearance Time**—for Four-Quadrant Gate systems at grade crossings, the amount of time provided to delay the descent of the exit gate arm(s) after entrance gate arm(s) begin to descend.
72. **Exit Gate Operating Mode**—for Four-Quadrant Gate systems at grade crossings, the mode of control used to govern the operation of the exit gate arms.
73. **Expressway**—“a divided arterial highway for through traffic with full or partial control of access with an excess of fifty percent of all crossroads separated in grade.” [4511.01(ZZ), ORC]
74. **Flagger**—a person who actively controls the flow of vehicular traffic into and/or through a temporary traffic control zone using hand-signaling devices or an Automated Flagger Assistance Device (AFAD).
75. **Flasher**—a device used to turn highway traffic signal indications on and off at a repetitive rate of approximately once per second.
76. **Flashing**—an operation in which a light source, such as a traffic signal indication, is turned on and off repetitively.
77. **Flashing-Light Signals**—a warning device consisting of two red signal indications arranged horizontally that are activated to flash alternately when rail traffic is approaching or present at a grade crossing.
78. **Flashing Mode**—a mode of operation in which at least one traffic signal indication in each vehicular signal face of a highway traffic signal is turned on and off repetitively.
79. **Freeway**—“a divided multi-lane highway for through traffic with all crossroads separated in grade and with full control of access.” [4511.01(Y Y), ORC]
80. **Full-Actuated Operation**—a type of traffic control signal operation in which all signal phases function on the basis of actuation.
81. **Gate**—an automatically-operated or manually-operated traffic control device that is used to physically obstruct road users such that they are discouraged from proceeding past a particular point on a roadway or pathway, or such that they are discouraged from entering a particular grade crossing, ramp, lane, roadway, or facility.
82. **Grade Crossing**—the general area where a highway and a railroad and/or light rail transit route cross at the same level, within which are included the tracks, highway, and traffic control devices for traffic traversing that area.
83. **Guide Sign**—a sign that shows route designations, destinations, directions, distances, services, points of interest, or other geographical, recreational, or cultural information.

84. **High Occupancy Vehicle (HOV)**—a motor vehicle carrying at least two or more persons, including carpools, vanpools, and buses.
85. **Highway (or Street)**—“the entire width between the boundary lines of every way open to the use of the public as a thoroughfare for purposes of vehicular travel.” [4511.01(BB), ORC]
86. **Highway, Controlled-Access**—“Every street or highway in respect to which owners or occupants of abutting lands and other persons have no legal right of access to or from the same except at such points only and in such manner as may be determined by the public authority having jurisdiction over such street or highway.” [4511.01 (CC), ORC]
87. **Highway, Through**—“Every street or highway as provided in section 4511.65 of the Revised Code.” [4511.01(HH), ORC]
88. **Highway-Light Rail Transit Grade Crossing**—the general area where a highway and a light rail transit route cross at the same level, within which are included the light rail transit tracks, highway, and traffic control devices for traffic traversing that area.
89. **Highway-Rail Grade Crossing**—the general area where a highway and a railroad cross at the same level, within which are included the railroad tracks, highway, and traffic control devices for highway traffic traversing that area.
90. **Highway Traffic Signal**—“a power-operated traffic control device by which traffic is warned or directed to take some specific action. ‘Highway traffic signal’ does not include a power-operated sign, steadily-illuminated pavement marker, warning light, or steady burning electric lamp.” [4511.01(MMM), ORC]
91. **HOV Lane**—any preferential lane designated for exclusive use by high-occupancy vehicles for all or part of a day—including a designated lane on a freeway, other highway, street, or independent roadway on a separate right-of-way.
92. **Hybrid Beacon**—“a type of beacon that is intentionally placed in a dark mode between periods of operation where no indications are displayed and, when in operation, displays both steady and flashing traffic control signal indications.” [4511.01(LL), ORC]
93. **Inherently Low Emission Vehicle (ILEV)**—any kind of vehicle that, because of inherent properties of the fuel system design, will not have significant evaporative emissions, even if its evaporative emission control system has failed.
94. **In-Roadway Lights**—a special type of highway traffic signal installed in the roadway surface to warn road users that they are approaching a condition on or adjacent to the roadway that might not be readily apparent and might require the road users to slow down and/or come to a stop.
95. **Interchange**—a system of interconnecting roadways providing for traffic movement between two or more highways that do not intersect at grade.
96. **Interconnection**— when used in Part 8, the electrical connection between the railroad or light rail transit active warning system and the highway traffic signal controller assembly for the purpose of preemption.
97. **Intermediate Interchange**—an interchange with an urban or rural route that is not a major or minor interchange as defined in this Section.
98. **Intersection**—“means:
 - (1) The area embraced within the prolongation or connection of the lateral curb lines, or, if none, the lateral boundary lines of the roadways of two highways that join one another at, or approximately at, right angles, or the area within which vehicles traveling upon different highways that join at any other angle might come into conflict. The junction of an alley or driveway with a roadway or highway does not constitute an intersection unless the roadway or highway at the junction is controlled by a traffic control device.
 - (2) If a highway includes two roadways that are thirty feet or more apart, then every crossing of each roadway of such divided highway by an intersecting highway constitutes a separate intersection. If both intersecting highways include two roadways thirty feet or more apart, then every crossing of any two roadways of such highways constitutes a separate intersection.
 - (3) At a location controlled by a traffic control signal, regardless of the distance between the separate intersections as defined in division (KK)(2) of this section:

- (a) If a stop line, yield line, or crosswalk has not been designated on the roadway within the median between the separate intersections, the two intersections and the roadway and median constitute one intersection.
- (b) Where a stop line, yield line, or crosswalk line is designated on the roadway on the intersection approach, the area within the crosswalk and any area beyond the designated stop line or yield line shall be part of the intersection.
- (c) Where a crosswalk is designated on a roadway on the departure from the intersection, the intersection shall include the area that extends to the far side of the crosswalk.” [4511.01(KK), ORC]

- 99. **Intersection Control Beacon**—a beacon used only at an intersection to control two or more directions of travel.
- 100. **Interval**—the part of a signal cycle during which signal indications do not change.
- 101. **Interval Sequence**—the order of appearance of signal indications during successive intervals of a signal cycle.
- 102. **Island**—a defined area between traffic lanes for control of vehicular movements, for toll collection, or for pedestrian refuge. It includes all end protection and approach treatments. Within an intersection area, a median or an outer separation is considered to be an island.
- 103. **Lane Drop**—see **Dropped Lane**.
- 104. **Lane Line Markings**—white pavement marking lines that delineate the separation of traffic lanes that have the same direction of travel on a roadway.
- 105. **Lane-Use Control Signal**—a signal face displaying indications to permit or prohibit the use of specific lanes of a roadway or to indicate the impending prohibition of such use.
- 106. **Legend**—see **Sign Legend**.
- 107. **Lens**—see **Signal Lens**.
- 108. **Light Rail Transit Traffic (Light Rail Transit Equipment)**—every device in, upon, or by which any person or property can be transported on light rail transit tracks, including single-unit light rail transit cars (such as streetcars and trolleys) and assemblies of multiple light rail transit cars coupled together.
- 109. **Locomotive Horn**—an air horn, steam whistle, or similar audible warning device (see 49 CFR Part 229.129) mounted on a locomotive or control cab car. The terms “locomotive horn,” “train whistle,” “locomotive whistle,” and “train horn” are used interchangeably in the railroad industry.
- 110. **Logo**—a distinctive emblem, or trademark that identifies a commercial business and/or the product or service offered by the business.
- 111. **Longitudinal Markings**—pavement markings that are generally placed parallel and adjacent to the flow of traffic such as lane lines, center lines, edge lines, channelizing lines, and others.
- 112. **Louver**—see **Signal Louver**.
- 113. **Luminance Contrast (or Contrast Ratio)**—a photometric term used herein in describing the ratio of luminance of the lighter element to the darker one in the same display for a changeable message sign.
- 114. **Major Interchange**—an interchange with another freeway or expressway, or an interchange with a high-volume multi-lane highway, principal urban arterial, or major rural route where the interchanging traffic is heavy or includes many road users unfamiliar with the area.
- 115. **Major Street**—the street normally carrying the higher volume of vehicular traffic.
- 116. **Malfunction Management Unit**—same as **Conflict Monitor**.
- 117. **Managed Lane**—a highway lane or set of lanes, or a highway facility, for which variable operational strategies such as direction of travel, tolling, pricing, and/or vehicle type or occupancy requirements are implemented and managed in real-time in response to changing conditions. Managed lanes are typically buffer- or barrier-separated lanes parallel to the general-purpose lanes of a highway in which access is restricted to designated locations. There are also some highways on which all lanes are managed.
- 118. **Manual Lane**—see **Attended Lane**.

119. **Maximum Highway Traffic Signal Preemption Time**—the maximum amount of time needed following initiation of the preemption sequence for the highway traffic signals to complete the timing of the right-of-way transfer time, queue clearance time, and separation time.
120. **Median**—“the area between two roadways of a divided highway, measured from edge of traveled way to edge of traveled way, but excluding turn lanes. The width of a median may be different between intersections, between interchanges, and at opposite approaches of the same intersection.” [4511.01(NNN), ORC]
121. **Minimum Track Clearance Distance**—for standard two-quadrant warning devices, the minimum track clearance distance is the length along a highway at one or more railroad or light rail transit tracks, measured from the highway stop line, warning device, or 12 feet perpendicular to the track center line, to 6 feet beyond the track(s) measured perpendicular to the far rail, along the center line or edge line of the highway, as appropriate, to obtain the longer distance. For Four-Quadrant Gate systems, the minimum track clearance distance is the length along a highway at one or more railroad or light rail transit tracks, measured either from the highway stop line or entrance warning device, to the point where the rear of the vehicle would be clear of the exit gate arm. In cases where the exit gate arm is parallel to the track(s) and is not perpendicular to the highway, the distance is measured either along the center line or edge line of the highway, as appropriate, to obtain the longer distance.
122. **Minimum Warning Time**—when used in Part 8, the least amount of time active warning devices shall operate prior to the arrival of rail traffic at a grade crossing.
123. **Minor Interchange**—an interchange where traffic is local and very light, such as interchanges with land service access roads. Where the sum of the exit volumes is estimated to be lower than 100 vehicles per day in the design year, the interchange is classified as local.
124. **Minor Street**—the street normally carrying the lower volume of vehicular traffic.
125. **Movable Bridge Resistance Gate**—a type of traffic gate, which is located downstream of the movable bridge warning gate, that provides a physical deterrent to vehicle and/or pedestrian traffic when placed in the appropriate position.
126. **Movable Bridge Signal**—a highway traffic signal installed at a movable bridge to notify traffic to stop during periods when the roadway is closed to allow the bridge to open.
127. **Movable Bridge Warning Gate**—a type of traffic gate designed to warn, but not primarily to block, vehicle and/or pedestrian traffic when placed in the appropriate position.
128. **Multi-Lane**—more than one lane moving in the same direction. A multi-lane street, highway, or roadway has a basic cross-section comprised of two or more through lanes in one or both directions. A multi-lane approach has two or more lanes moving toward the intersection, including turning lanes.
129. **Neutral Area**—the paved area between the channelizing lines separating an entrance or exit ramp or a channelized turn lane or channelized entering lane from the adjacent through lane(s).
130. **Object Marker**—a device used to mark obstructions within or adjacent to the roadway.
131. **Occupancy Requirement**—any restriction that regulates the use of a facility or one or more lanes of a facility for any period of the day based on a specified number of persons in a vehicle.
132. **Occupant**—a person driving or riding in a car, truck, bus, or other vehicle.
133. **Open-Road ETC Lane**—a non-attended lane that is designed to allow toll payments to be electronically collected from vehicles traveling at normal highway speeds. Open-Road ETC lanes are typically physically separated from the toll plaza, often following the alignment of the mainline lanes, with toll plaza lanes for cash toll payments being on a different alignment after diverging from the mainline lanes or a subset thereof.
134. **Open-Road Tolling**—a system designed to allow electronic toll collection (ETC) from vehicles traveling at normal highway speeds. Open-Road Tolling might be used on toll roads or toll facilities in conjunction with toll plazas. Open-Road Tolling is also typically used on managed lanes and on toll facilities that only accept payment by ETC.
135. **Open-Road Tolling Point**—the location along an Open-Road ETC lane at which roadside or overhead detection and receiving equipment are placed and vehicles are electronically assessed a toll.

136. **Operator**—see **Driver**.
137. **Opposing Traffic**—vehicles that are traveling in the opposite direction. At an intersection, vehicles entering from an approach that is approximately straight ahead would be considered to be opposing traffic, but vehicles entering from approaches on the left or right would not be considered to be opposing traffic.
138. **Overhead Sign**—a sign that is placed such that a portion or the entirety of the sign or its support is directly above the roadway or shoulder such that vehicles travel below it. Typical installations include signs placed on cantilever arms that extend over the roadway or shoulder, on sign support structures that span the entire width of the pavement, on mast arms or span wires that also support traffic control signals, and on highway bridges that cross over the roadway.
139. **Parking Area**—a parking lot or parking garage that is separated from a roadway. Parallel or angle parking spaces along a roadway are not considered a parking area.
140. **Passive Grade Crossing**—a grade crossing where none of the automatic traffic control devices associated with an Active Grade Crossing Warning System are present and at which the traffic control devices consist entirely of signs and/or markings.
141. **Pathway**—a general term denoting a public way for purposes of travel by authorized users outside the traveled way and physically separated from the roadway by an open space or barrier and either within the highway right-of-way or within an independent alignment. Pathways include shared-use paths, but do not include sidewalks.
142. **Pathway Grade Crossing**—the general area where a pathway and railroad or light rail transit tracks cross at the same level, within which are included the tracks, pathway, and traffic control devices for pathway traffic traversing that area.
143. **Paved**—a bituminous surface treatment, mixed bituminous concrete, or Portland cement concrete roadway surface that has both a structural (weight bearing) and a sealing purpose for the roadway.
144. **Pedestrian**—“any natural person afoot.” [4511.01(X), ORC] However, for purposes of this Manual the term Pedestrian also includes a person on foot, in a wheelchair, on skates, or on a skateboard.
145. **Pedestrian Change Interval**—an interval during which the flashing UPRAISED HAND (symbolizing DONT WALK) signal indication is displayed.
146. **Pedestrian Clearance Time**—the time provided for a pedestrian crossing in a crosswalk, after leaving the curb or shoulder, to travel to the far side of the traveled way or to a median.
147. **Pedestrian Facilities**—a general term denoting improvements and provisions made to accommodate or encourage walking.
148. **Pedestrian Hybrid Beacon**— a special type of hybrid beacon used to warn and control traffic at an unsignalized location to assist pedestrians in crossing a street or highway at a marked crosswalk.
149. **Pedestrian Signal Head**—a signal head, which contains the symbols WALKING PERSON (symbolizing WALK) and UPRAISED HAND (symbolizing DONT WALK), that is installed to direct pedestrian traffic at a traffic control signal.
150. **Permissive Mode**—a mode of traffic control signal operation in which left or right turns are permitted to be made after yielding to pedestrians, if any, and/or opposing traffic, if any. When a CIRCULAR GREEN signal indication is displayed, both left and right turns are permitted unless otherwise prohibited by another traffic control device. When a flashing YELLOW ARROW signal indication is displayed, the turn indicated by the arrow is permitted.
151. **Physical Gore**—a longitudinal point where a physical barrier or the lack of a paved surface inhibits road users from crossing from a ramp or channelized turn lane or channelized entering lane to the adjacent through lane(s) or vice versa.
152. **Pictograph**—a pictorial representation used to identify a governmental jurisdiction, an area of jurisdiction, a governmental agency, a military base or branch of service, a governmental-approved university or college, a toll payment system, or a government-approved institution.
153. **Plaque**—a traffic control device intended to communicate specific information to road users through a word, symbol, or arrow legend that is placed immediately adjacent to a sign to

- supplement the message on the sign. The difference between a plaque and a sign is that a plaque cannot be used alone. The designation for a plaque includes a “P” suffix.
154. **Platoon**—a group of vehicles or pedestrians traveling together as a group, either voluntarily or involuntarily, because of traffic signal controls, geometrics, or other factors.
 155. **Portable Traffic Control Signal**—a temporary traffic control signal that is designed so that it can be easily transported and reused at different locations.
 156. **Post-Mounted Sign**—a sign that is placed to the side of the roadway such that no portion of the sign or its support is directly above the roadway or shoulder.
 157. **Posted Speed Limit**—a speed limit determined by law or regulation and displayed on Speed Limit signs.
 158. **Preemption**—the transfer of normal operation of a traffic control signal to a special control mode of operation.
 159. **Preferential Lane**—a highway lane reserved for the exclusive use of one or more specific types of vehicles or vehicles with at least a specific number of occupants.
 160. **Pre-Signal**—traffic control signal faces that control traffic approaching a grade crossing in conjunction with the traffic control signal faces that control traffic approaching a highway-highway intersection beyond the tracks. Supplemental near-side traffic control signal faces for the highway-highway intersection are not considered pre-signals. Pre-signals are typically used where the clear storage distance is insufficient to store one or more design vehicles.
 161. **Pretimed Operation**—a type of traffic control signal operation in which none of the signal phases function on the basis of actuation.
 162. **Primary Signal Face**—one of the required or recommended minimum number of signal faces for a given approach or separate turning movement, but not including near-side signal faces required as a result of the far-side signal faces exceeding the maximum distance from the stop line.
 163. **Principal Legend**—place names, street names, and route numbers placed on guide signs.
 164. **Priority Control**—a means by which the assignment of right-of-way is obtained or modified.
 165. **Private Road Open to Public Travel**—“private toll road or road including any adjacent sidewalks that generally run parallel to the road, within a shopping center, airport, sports arena, or other similar business or recreation facility that is privately owned but where the public is allowed to travel without access restrictions. “Private road open to public travel” includes a gated toll road but does not include a road within a private gated property where access is restricted at all times, a parking area, a driving aisle within a parking area, or a private grade crossings.” [4511.01(OOO), ORC]
 166. **Protected Mode**—a mode of traffic control signal operation in which left or right turns are permitted to be made when a left or right GREEN ARROW signal indication is displayed.
 167. **Public Road**—any road, street, or similar facility under the jurisdiction of and maintained by a public agency and open to public travel.
 168. **Pushbutton**—a button to activate a device or signal timing for pedestrians, bicyclists, or other road users.
 169. **Pushbutton Information Message**—a recorded message that can be actuated by pressing a pushbutton when the walk interval is not timing and that provides the name of the street that the crosswalk associated with that particular pushbutton crosses and can also provide other information about the intersection signalization or geometry.
 170. **Pushbutton Locator Tone**—a repeating sound that informs approaching pedestrians that a pushbutton exists to actuate pedestrian timing or receive additional information and that enables pedestrians who have visual disabilities to locate the pushbutton.
 171. **Queue Clearance Time**—when used in Part 8, the time required for the design vehicle of maximum length stopped just inside the minimum track clearance distance to start up and move through and clear the entire minimum track clearance distance. If pre-signals are present, this time shall be long enough to allow the vehicle to move through the intersection, or to clear the tracks if there is sufficient clear storage distance. If a Four-Quadrant Gate system is present, this time shall be long enough to permit the exit gate arm to lower after the design vehicle is clear of the minimum track clearance distance.

- 172. Quiet Zone**—a segment of a rail line, with one or a number of consecutive public highway-rail grade crossings at which locomotive horns are not routinely sounded per 49 CFR Part 222.
- 173. Rail Traffic**—every device in, upon, or by which any person or property can be transported on rails or tracks and to which all other traffic must yield the right-of-way by law at grade crossings, including trains, one or more locomotives coupled (with or without cars), other railroad equipment, and light rail transit operating in exclusive or semi-exclusive alignments. Light rail transit operating in a mixed-use alignment, to which other traffic is not required to yield the right-of-way by law, is a vehicle and is not considered to be rail traffic.
- 174. Railroad**—“a carrier of persons or property operating upon rails placed principally on a private right-of-way.” [4511.01(P), ORC]
- 175. Raised Pavement Marker**—a device mounted on or in a road surface that has a height generally not exceeding approximately 1 inch above the road surface for a permanent marker, or not exceeding approximately 2 inches above the road surface for a temporary flexible marker, and that is intended to be used as a positioning guide and/or to supplement or substitute for pavement markings.
- 176. Ramp Control Signal**—a highway traffic signal installed to control the flow of traffic onto a freeway at an entrance ramp or at a freeway-to-freeway ramp connection.
- 177. Ramp Meter**—see Ramp Control Signal.
- 178. Red Clearance Interval**—an interval that follows a yellow change interval and precedes the next conflicting green interval.
- 179. Regulatory Sign**—a sign that gives notice to road users of traffic laws or regulations.
- 180. Retroreflectivity**—a property of a surface that allows a large portion of the light coming from a point source to be returned directly back to a point near its origin.
- 181. Right-of-Way**—“means either of the following, as the context requires:
- (1) The right of a vehicle, streetcar, trackless trolley, or pedestrian to proceed uninterruptedly in a lawful manner in the direction in which it or the individual is moving in preference to another vehicle, streetcar, trackless trolley, or pedestrian approaching from a different direction into its or the individual's path;
 - (2) A general term denoting land, property, or the interest therein, usually in the configuration of a strip, acquired for or devoted to transportation purposes. When used in this context, right-of-way includes the roadway, shoulders or berm, ditch, and slopes extending to the right-of-way limits under the control of the state or local authority.” [4511.01 (UU), ORC]
- 182. Road**—see Roadway.
- 183. Road User**—a vehicle operator, bicyclist, or pedestrian, including persons with disabilities, within the highway or on a private road open to public travel.
- 184. Roadway**—“that portion of a highway improved, designed, or ordinarily used for vehicular travel, except the berm or shoulder. If a highway includes two or more separate roadways the term "roadway" means any such roadway separately but not all such roadways collectively.” [4511.01(EE), ORC]
- 185. Roadway Network**—a geographical arrangement of intersecting roadways.
- 186. Roundabout**—a circular intersection with yield control at entry, which permits a vehicle on the circulatory roadway to proceed, and with deflection of the approaching vehicle counter-clockwise around a central island.
- 187. Rumble Strip**—a series of intermittent, narrow, transverse areas of rough-textured, slightly raised, or depressed road surface that extend across the travel lane to alert road users to unusual traffic conditions or are located along the shoulder, along the roadway center line, or within islands formed by pavement markings to alert road users that they are leaving the travel lanes.
- 188. Rural Highway**—a type of roadway normally characterized by lower volumes, higher speeds, fewer turning conflicts, and less conflict with pedestrians.
- 189. Safe-Positioned**—the positioning of emergency vehicles at an incident in a manner that attempts to protect both the responders performing their duties and road users traveling

- through the incident scene, while minimizing, to the extent practical, disruption of the adjacent traffic flow.
190. **Safety Zone**—“the area or space officially set apart within a roadway for the exclusive use of pedestrians and protected or marked or indicated by adequate signs as to be plainly visible at all times.” [4511.01(MM), ORC]
 191. **School**—see ORC Division 4511.21(B)(1)(b) (see Appendix B2).
 192. **School Zone**—see ORC Division 4511.21(B)(1)(c) (see Appendix B2).
 193. **Semi-Actuated Operation**—a type of traffic control signal operation in which at least one, but not all, signal phases function on the basis of actuation.
 194. **Separate Turn Signal Face**—a signal face that exclusively controls a turn movement and that displays signal indications that are applicable only to the turn movement.
 195. **Separation Time**—the component of maximum highway traffic signal preemption time during which the minimum track clearance distance is clear of vehicular traffic prior to the arrival of rail traffic.
 196. **Shared Roadway**—a roadway that is officially designated and marked as a bicycle route, but which is open to motor vehicle travel and upon which no bicycle lane is designated.
 197. **Shared Turn Signal Face**—a signal face, for controlling both a turn movement and the adjacent through movement, that always displays the same color of circular signal indication that the adjacent through signal face or faces display.
 198. **Shared-Use Path**—“a bikeway outside the traveled way and physically separated from motorized vehicular traffic by an open space or barrier and either within the highway right-of-way or within an independent alignment. A shared-use path also may be used by pedestrians, including skaters, joggers, users of manual and motorized wheelchairs, and other authorized motorized and non-motorized users.” [4511.01(PPP), ORC]
 199. **Sidewalk**—“that portion of a street between the curb lines, or the lateral lines of a roadway, and the adjacent property lines, intended for the use of pedestrians.” [4511.01(FF), ORC]
 200. **Sign**—any traffic control device that is intended to communicate specific information to road users through a word, symbol, and/or arrow legend. Signs do not include highway traffic signals, pavement markings, delineators, or channelization devices.
 201. **Sign Assembly**—a group of signs, located on the same support(s), that supplement one another in conveying information to road users.
 202. **Sign Illumination**—either internal or external lighting that shows similar color by day or night. Street or highway lighting shall not be considered as meeting this definition.
 203. **Sign Legend**—all word messages, logos, pictographs and symbol and arrow designs that are intended to convey specific meanings. The border, if any, on a sign is not considered to be a part of the legend.
 204. **Sign Panel**—a separate panel or piece of material containing a word, symbol, and/or arrow legend that is affixed to the face of a sign.
 205. **Signal Backplate**—a thin strip of material that extends outward from and parallel to a signal face on all sides of a signal housing to provide a background for improved visibility of the signal indications.
 206. **Signal Coordination**—the establishment of timed relationships between adjacent traffic control signals.
 207. **Signal Face**—an assembly of one or more signal sections that is provided for controlling one or more traffic movements on a single approach.
 208. **Signal Head**—an assembly of one or more signal faces that is provided for controlling traffic movements on one or more approaches.
 209. **Signal Housing**—that part of a signal section that protects the light source and other required components.
 210. **Signal Indication**—the illumination of a signal lens or equivalent device.
 211. **Signal Lens**—that part of the signal section that redirects the light coming directly from the light source and its reflector, if any.
 212. **Signal Louver**—a device that can be mounted inside a signal visor to restrict visibility of a signal indication from the side or to limit the visibility of the signal indication to a certain lane or lanes, or to a certain distance from the stop line.

213. **Signal Phase**—the right-of-way, yellow change, and red clearance intervals in a cycle that are assigned to an independent traffic movement or combination of movements.
214. **Signal Section**—the assembly of a signal housing, signal lens, if any, and light source with necessary components to be used for displaying one signal indication.
215. **Signal System**—two or more traffic control signals operating in signal coordination.
216. **Signal Timing**—the amount of time allocated for the display of a signal indication.
217. **Signal Visor**—that part of a signal section that directs the signal indication specifically to approaching traffic and reduces the effect of direct external light entering the signal lens.
218. **Signing**—individual signs or a group of signs, not necessarily on the same support(s), that supplement one another in conveying information to road users.
219. **Simultaneous Preemption**—notification of approaching rail traffic is forwarded to the highway traffic signal controller unit or assembly and railroad or light rail transit active warning devices at the same time.
220. **Special Purpose Road**—a low-volume, low-speed road that serves recreational areas or resource development activities.
221. **Speed**—speed is defined based on the following classifications:
 - (a) **Average Speed**—the summation of the instantaneous or spot-measured speeds at a specific location of vehicles divided by the number of vehicles observed.
 - (b) **Design Speed**—a selected speed used to determine the various geometric design features of a roadway.
 - (c) **85th-Percentile Speed**—the speed at or below which 85 percent of the motor vehicles travel.
 - (d) **Operating Speed**—a speed at which a typical vehicle or the overall traffic operates. Operating speed might be defined with speed values such as the average, pace, or 85th-percentile speeds.
 - (e) **Pace**—the 10 mph speed range representing the speeds of the largest percentage of vehicles in the traffic stream.
222. **Speed Limit**—the maximum (or minimum) speed applicable to a section of highway as established by law or regulation.
223. **Speed Limit Sign Beacon**—a beacon used to supplement a SPEED LIMIT sign.
224. **Speed Measurement Marking**—a white transverse pavement marking placed on the roadway to assist the enforcement of speed regulations.
225. **Speed Zone**—a section of highway with a speed limit that is established by law or regulation but which might be different from a legislatively specified statutory speed limit.
226. **Splitter Island**—a median island used to separate opposing directions of traffic entering and exiting a roundabout.
227. **State Highway**—“a highway under the jurisdiction of the department of transportation, outside the limits of municipal corporations, provided that the authority conferred upon the director of transportation in section 5511.01 of the Revised Code to erect state highway route markers and signs directing traffic shall not be modified by sections 4511.01 to 4511.79, and 4511.99 of the Revised Code.” [4511.01(II), ORC]
228. **State Route**—“every highway which is designated with an official state route number and so marked.” [4511.01(JJ), ORC]
229. **Station Crossing**—a pathway grade crossing that is associated with a station platform.
230. **Statutory Speed Limit**—a speed limit established by legislative action that typically is applicable for a particular class of highways with specified design, functional, jurisdictional and/or location characteristics and that is not necessarily displayed on Speed Limit signs.
231. **Steady (Steady Mode)**—the continuous display of a signal indication for the duration of an interval, signal phase, or consecutive signal phases.
232. **Stop Beacon**—a beacon used to supplement a STOP sign, a DO NOT ENTER sign, or a WRONG WAY sign.
233. **Stop Line**—a solid white pavement marking line extending across approach lanes to indicate the point at which a stop is intended or required to be made.
234. **Street**—see Highway.

235. **Supplemental Signal Face**—a signal face that is not a primary signal face but which is provided for a given approach or separate turning movement to enhance visibility or conspicuity.
236. **Symbol**—the approved design of a pictorial representation of a specific traffic control message for signs, pavement markings, traffic control signals, or other traffic control devices, as shown in the National MUTCD.
237. **Temporary Traffic Control Signal**—a traffic control signal that is installed for a limited time period.
238. **Temporary Traffic Control Zone**—an area of a highway where road user conditions are changed because of a work zone or incident by the use of temporary traffic control devices, flaggers, uniformed law enforcement officers, or other authorized personnel.
239. **Theoretical Gore**—a longitudinal point at the upstream end of a neutral area at an exit ramp or channelized turn lane where the channelizing lines that separate the ramp or channelized turn lane from the adjacent through lane(s) begin to diverge, or a longitudinal point at the downstream end of a neutral area at an entrance ramp or channelized entering lane where the channelizing lines that separate the ramp or channelized entering lane from the adjacent through lane(s) intersect each other.
240. **Timed Exit Gate Operating Mode**—a mode of operation where the exit gate descent at a grade crossing is based on a predetermined time interval.
241. **Toll Booth**—a shelter where a toll attendant is stationed to collect tolls or issue toll tickets. A toll booth is located adjacent to a toll lane and is typically set on a toll island.
242. **Toll Island**—a raised island on which a toll booth or other toll collection and related equipment are located.
243. **Toll Lane**—an individual lane located within a toll plaza in which a toll payment is collected or, for toll-ticket systems, a toll ticket is issued.
244. **Toll Plaza**—the location at which tolls are collected consisting of a grouping of toll booths, toll islands, toll lanes, and, typically, a canopy. Toll plazas might be located on highway mainlines or on interchange ramps. A mainline toll plaza is sometimes referred to as a barrier toll plaza because it interrupts the traffic flow.
245. **Toll-Ticket System**—a system in which the user of a toll road receives a ticket from a machine or toll booth attendant upon entering a toll system. The ticket denotes the user's point of entry and, upon exiting the toll system, the user surrenders the ticket and is charged a toll based on the distance traveled between the points of entry and exit.
246. **Traffic**—"pedestrians, ridden or herded animals, vehicles, streetcars, trackless trolleys, and other devices, either singly or together, while using for purposes of travel any highway or private road open to public travel." [4511.01(TT), ORC]
247. **Traffic Control Device**—"a flagger, sign, signal, marking, or other device used to regulate, warn, or guide traffic, placed on, over, or adjacent to a street, highway, private road open to public travel, pedestrian facility, or shared-use path by authority of a public agency or official having jurisdiction, or, in the case of a private road open to public travel, by authority of the private owner or private official having jurisdiction." [4511.01(QQ), ORC]
248. **Traffic Control Signal (Traffic Signal)**—"any highway traffic signal by which traffic is alternately directed to stop and permitted to proceed." [4511.01(RR), ORC]
249. **Train**—one or more locomotives coupled, with or without cars, that operates on rails or tracks and to which all other traffic must yield the right-of-way by law at highway-rail grade crossings.
The ORC defines "Railroad train" as "a steam engine or an electric or other motor, with or without cars coupled thereto, operated by a railroad." [4511.01(Q), ORC]
250. **Transverse Markings**—pavement markings that are generally placed perpendicular and across the flow of traffic such as shoulder markings; word, symbol, and arrow markings, stop lines, crosswalk lines, speed measurement markings, parking space markings, and others.
251. **Traveled Way**—the portion of the roadway for the movement of vehicles, exclusive of the shoulders, berms, sidewalks, and parking lanes.

- 252. Turn Bay**—a lane for the exclusive use of turning vehicles that is formed on the approach to the location where the turn is to be made. In most cases where turn bays are provided, drivers who desire to turn must move out of a through lane into the newly formed turn bay in order to turn. A through lane that becomes a turn lane is considered to be a dropped lane rather than a turn bay.
- 253. Upstream**—a term that refers to a location that is encountered by traffic prior to a downstream location as it flows in an “upstream to downstream” direction. For example, “the upstream end of a lane line separating the turn lane from a through lane on the approach to an intersection” is the end of the line that is furthest from the intersection.
- 254. Urban Street**—a type of street normally characterized by relatively low speeds, wide ranges of traffic volumes, narrower lanes, frequent intersections and driveways, significant pedestrian traffic, and more businesses and houses.
- 255. Vehicle**—“every device, including a motorized bicycle, in, upon, or by which any person or property may be transported or drawn upon a highway, except that “vehicle” does not include any motorized wheelchair, any electric personal assistive mobility device, any device that is moved by power collected from overhead electric trolley wires or that is used exclusively upon stationary rails or tracks, or any device, other than a bicycle, that is moved by human power.” [4511.01(A), ORC]
- 256. Vehicle, Emergency**—“emergency vehicles of municipal, township, or county departments or public utility corporations when identified as such as required by law, the director of public safety, or local authorities, and motor vehicles when commandeered by a police officer.” [4511.01(D), ORC]
- 257. Vehicle, Motor**—“every vehicle propelled or drawn by power other than muscular power or power collected from overhead electric trolley wires, except motorized bicycles, road rollers, traction engines, power shovels, power cranes, and other equipment used in construction work and not designed for or employed in general highway transportation, hole-digging machinery, well-drilling machinery, ditch-digging machinery, farm machinery, and trailers designed and used exclusively to transport a boat between a place of storage and a marina, or in and around a marina, when drawn or towed on a street or highway for a distance of no more than ten miles and at a speed of twenty-five miles per hour or less.” [4511.01(B), ORC]
- 258. Vehicle, Public Safety**—“means any of the, following:
- (1) Ambulances, including private ambulance companies under contract to a municipal corporation, township, or county, and private ambulances and nontransport vehicles bearing license plates issued under section 4503.49 of the Revised Code;
 - (2) Motor vehicles used by public law enforcement officers or other persons sworn to enforce the criminal and traffic laws of the state;
 - (3) Any motor vehicle when properly identified as required by the director of public safety, when used in response to fire emergency calls or to provide emergency medical service to ill or injured persons, and when operated by a duly qualified person who is a member of a volunteer rescue service or a volunteer fire department, and who is on duty pursuant to the rules or directives of that service. The state fire marshal shall be designated by the director of public safety as the certifying agency for all public safety vehicles described in division (E)(3) of this section.
 - (4) Vehicles used by fire departments, including motor vehicles when used by volunteer fire fighters responding to emergency calls in the fire department service when identified as required by the director of public safety.
Any vehicles used to transport or provide emergency medical service to an ill or injured person, when certified as a public safety vehicle, shall be considered a public safety vehicle when transporting an ill or injured person to a hospital regardless of whether such vehicle has already passed a hospital.
 - (5) Vehicles used by the commercial motor vehicle safety enforcement unit for the enforcement of orders and rules of the public utilities commission as specified in section 5503.34 of the Revised Code.” [4511.01(E), ORC]
- 259. Vibrotactile Pedestrian Device**—an accessible pedestrian signal feature that communicates, by touch, information about pedestrian timing using a vibrating surface.

- 260. Visibility-Limited Signal Face or Visibility-Limited Signal Section**—a type of signal face or signal section designed (or shielded, hooded, or louvered) to restrict the visibility of a signal indication from the side, to a certain lane or lanes, or to a certain distance from the stop line.
- 261. Walk Interval**—an interval during which the WALKING PERSON (symbolizing WALK) signal indication is displayed.
- 262. Warning Beacon**—a beacon used only to supplement an appropriate warning or regulatory sign or marker.
- 263. Warning Light**—a portable, powered, yellow, lens-directed, enclosed light that is used in a temporary traffic control zone in either a steady burn or a flashing mode.
- 264. Warning Sign**—a sign that gives notice to road users of a situation that might not be readily apparent.
- 265. Warrant**—a warrant describes a threshold condition based upon average or normal conditions that, if found to be satisfied as part of an engineering study, shall result in analysis of other traffic conditions or factors to determine whether a traffic control device or other improvement is justified. Warrants are not a substitute for engineering judgment. The fact that a warrant for a particular traffic control device is met is not conclusive justification for the installation of the device.
- 266. Wayside Equipment**—the signals, switches, and/or control devices for railroad or light rail transit operations housed within one or more enclosures located along the railroad or light rail transit right-of-way and/or on railroad or light rail transit property.
- 267. Wayside Horn System**—a stationary horn (or series of horns) located at a grade crossing that is used in conjunction with train-activated or light rail transit-activated warning systems to provide audible warning of approaching rail traffic to road users on the highway or pathway approaches to a grade crossing, either as a supplement or alternative to the sounding of a locomotive horn.
- 268. Worker**—a person on foot whose duties place him or her within the right-of-way of a street, highway, or pathway, such as street, highway, or pathway construction and maintenance forces, survey crews, utility crews, responders to incidents within the street, highway, or pathway right-of-way, and law enforcement personnel when directing traffic, investigating crashes, and handling lane closures, obstructed roadways, and disasters within the right-of-way of a street, highway, or pathway.
- 269. Wrong-Way Arrow**—a slender, elongated, white pavement marking arrow placed upstream from the ramp terminus to indicate the correct direction of traffic flow. Wrong-way arrows are intended primarily to warn wrong-way road users that they are going in the wrong direction.
- 270. Yellow Change Interval**—the first interval following the green or flashing arrow interval during which the steady yellow signal indication is displayed.
- 271. Yield Line**—a row of solid white isosceles triangles pointing toward approaching vehicles extending across approach lanes to indicate the point at which the yield is intended or required to be made.

Section 1A.14 Meanings of Acronyms and Abbreviations in this Manual

Standard:

- 01 The following acronyms and abbreviations, when used in this Manual, shall have the following meanings:

1. AADT—annual average daily traffic
2. AASHTO—American Association of State Highway and Transportation Officials
3. ADA—Americans with Disabilities Act
4. ADAAG—Americans with Disabilities Accessibility Guidelines
5. ADT—average daily traffic
6. AFAD—Automated Flagger Assistance Device
7. ANSI—American National Standards Institute
8. CFR—Code of Federal Regulations

9. CMS—changeable message sign
10. dBA—A-weighted decibels
11. EPA—Environmental Protection Agency
12. ETC—electronic toll collection
13. EV—electric vehicle
14. FHWA—Federal Highway Administration
15. FRA—Federal Railroad Administration
16. FTA—Federal Transit Administration
17. HOT—high occupancy tolls
18. HOTM—FHWA’s Office of Transportation Management
19. HOTO—FHWA’s Office of Transportation Operations
20. HOV—high-occupancy vehicle
21. ILEV—inherently low emission vehicle
22. ISEA—International Safety Equipment Association
23. ITE—Institute of Transportation Engineers
24. ITS—intelligent transportation systems
25. LED—light emitting diode
26. LP—liquid petroleum
27. LRT – light rail transit
28. MPH or mph—miles per hour
29. MASH—“Manual for Assessing Safety Hardware”
30. MUTCD—“Manual on Uniform Traffic Control Devices”
31. NCHRP—National Cooperative Highway Research Program
32. OAC—Ohio Administrative Code
33. ODOT—Ohio Department of Transportation
34. OMUTCD—“Ohio Manual of Uniform Traffic Control Devices”
35. ORC—Ohio Revised Code
36. ORT—open-road tolling
37. OTE—Office of Traffic Engineering (ODOT)
38. PUCO—Public Utilities Commission
39. PCMS—portable changeable message sign
40. PRT—perception-response time
41. RPM—raised pavement marker
42. RRPM—raised retroreflective pavement marker
43. RV—recreational vehicle
44. SDMM—“Sign Designs and Markings Manual”
45. TDD—telecommunication devices for the deaf
46. TEM—“Traffic Engineering Manual”
47. TRB—Transportation Research Board
48. TTC—temporary traffic control
49. U.S.—United States
50. U.S.C.—United States Code
51. USDOT—United States Department of Transportation
52. UVC—Uniform Vehicle Code
53. VPH or vph—vehicles per hour

Section 1A.15 Abbreviations Used on Traffic Control Devices

Standard:

- 01 When the word messages shown in Table 1A-1 need to be abbreviated in connection with traffic control devices, the abbreviations shown in Table 1A-1 shall be used.
- 02 When the word messages shown in Table 1A-2 need to be abbreviated on a portable changeable message sign, the abbreviations shown in Table 1A-2 shall be used. Unless indicated by an asterisk, these abbreviations shall only be used on portable changeable message signs.

Guidance:

- 03 *The abbreviations for the words listed in Table 1A-2 that also show a prompt word should not be used on a portable changeable message sign unless the prompt word shown in Table 1A-2 either precedes or follows the abbreviation, as applicable.*

Standard:

- 04 **The abbreviations shown in Table 1A-3 shall not be used in connection with traffic control devices because of their potential to be misinterpreted by road users.**

Guidance:

- 05 *If multiple abbreviations are permitted in Table 1A-1 or 1A-2, the same abbreviation should be used throughout a single jurisdiction.*
- 06 *Except as otherwise provided in Table 1A-1 or 1A-2 or unless necessary to avoid confusion, periods, commas, apostrophes, question marks, ampersands, and other punctuation marks or characters that are not letters or numerals should not be used in any abbreviation.*

Table 1A-1. Acceptable Abbreviations

Word Message	Standard Abbreviation
Afternoon / Evening	PM
Alternate	ALT
AM Radio	AM
Avenue	AVE, AV
Bicycle	BIKE
Boulevard	BLVD
Bridge	(See Table 1A-2)
CB Radio	CB
Center (as part of a place name)	CTR
Circle	CIR*
Civil Defense	CD
Compressed Natural Gas	CNG
Court	CT*
Crossing (other than highway-rail)	X-ING
Drive	DR*
East	E
Electric Vehicle	EV
Expressway	EXPWY*
Feet	FT
FM Radio	FM
Freeway	FRWY, FWY*
Friday	FRI
Hazardous Material	HAZMAT*
High Occupancy Vehicle	HOV
Highway	HWY*
Hospital	HOSP
Hour(s)	HR, HRS
Information	INFO
Inherently Low Emission Vehicle	ILEV
International	INTL
Interstate	(See Table 1A-2)
Junction / Intersection	JCT
Lane	(See Table 1A-2)
Liquid Propane Gas	LP-GAS
Maximum	MAX

Word Message	Standard Abbreviation
Mile(s)	MI
Miles Per Hour	MPH
Minimum	MIN
Minute(s)	MIN
Monday	MON
Morning / Late Night	AM
Mount	MT
Mountain	MTN
National	NATL
North	N
Parkway	PKWY*
Pedestrian	PED
Place	PL*
Pounds	LBS
Road	RD*
Saint	ST
Saturday	SAT
South	S
State, county, or other non-US or non-interstate numbered route	(See Table 1A-2)
Street	ST*
Sunday	SUN
Telephone	PHONE
Temporary	TEMP
Terrace	TER*
Thursday	THURS
Thruway	THWY*
Tons of Weight	T
Trail	TR*
Tuesday	TUES*
Turnpike	TPK*
Two-Way Intersection	2-WAY
US Numbered Route	US
Wednesday	WED
West	W

*This abbreviation shall not be used for any application other than the name of a roadway.

Table 1A-2. Abbreviations That Shall be Used Only on Portable Changeable Message Signs

Word Message	Standard Abbreviation	Prompt Word That Should Precede the Abbreviation	Prompt Word That Should Follow the Abbreviation
Access	ACCS	—	Road
Ahead	AHD	Fog	—
Blocked	BLKD	Lane	—
Bridge	BR*	[Name]	—
Cannot		—	—
Center	CNTR	—	Lane
Chemical	CHEM	—	Spill
Condition	COND	Traffic	—
Congested	CONG	Traffic	—
Construction	CONST	—	Ahead
Crossing	XING	—	—
Do Not	DONT	—	—
Downtown	DWNTN	—	Traffic
Eastbound	E-BND	—	—
Emergency	EMER	—	—
Entrance Enter	ENT	—	—
Exit	EX	Next	—
Express	EXP	—	Lane
Frontage	FRNTG	—	Road
Hazardous	HAZ	—	Driving
Highway-Rail Grade Crossing	RR XING	—	—
Interstate	I-*	—	[Number]
It Is	ITS	—	—
Lane	LN	[Roadway Name]*, Right, Left, Center	—
Left	LFT	—	—
Local	LOC	—	Traffic
Lower	LWR	—	Level
Maintenance	MAINT	—	—
Major	MAJ	—	Accident
Minor	MNR	—	Accident
Normal	NORM	—	—
Northbound	N-BND	—	—
Oversized	OVRSZ	—	Load
Parking	PKING	—	—
Pavement	PVMT	Wet	—
Prepare	PREP	—	To Stop
Quality	QLTY	Air	—
Right	RT	Keep, Next	—
Right	RT	—	Lane
Roadwork	RDWK	—	Ahead, [Distance]
Route	RT, RTE	Best	—
Service	SERV	—	—
Shoulder	SHLDR	—	—
Slippery	SLIP	—	—
Southbound	S-BND	—	—
Speed	SPD	—	—
State, county, or other non-US or non-Interstate numbered route	[Route Abbreviation determined by highway agency]**	—	Number
Tires with Lugs	LUGS	—	—
Traffic	TRAF	—	—
Travelers	TRVLRS	—	—
Two-Wheeled Vehicles	CYCLES	—	—
Upper	UPR	—	Level
Vehicle(s)	VEH, VEHS	—	—
Warning	WARN	—	—
Westbound	W-BND	—	—
Will Not	WONT	—	—

* This abbreviation, when accompanied by the prompt word, may be used on traffic control devices other than portable changeable message signs.

** A space and no dash shall be placed between the abbreviation and the number of the route.

Table 1A-3. Unacceptable Abbreviations

Abbreviation	Intended Word	Common Misinterpretation
ACC	Accident	Access (Road)
CLRS	Clears	Colors
DLY	Delay	Daily
FDR	Feeder	Federal
L	Left	Lane (Merge)
LT	Light (Traffic)	Left
PARK	Parking	Park
POLL	Pollution (Index)	Poll
RED	Reduce	Red
STAD	Stadium	Standard
WRGN	Warning	Wrong

CHAPTER 2A. GENERAL

Section 2A.01 Function and Purpose of Signs

Support:

- 01 This Manual contains Standards, Guidance, and Options for the signing of all types of highways, and private roads open to public travel. The functions of signs are to provide regulations, warnings, and guidance information for road users. Words, symbols, and arrows are used to convey the messages. Signs are not typically used to confirm rules of the road.
- 02 Detailed sign requirements are located in the following Chapters of Part 2:
- Chapter 2B—Regulatory Signs, Barricades, and Gates
 - Chapter 2C—Warning Signs and Object Markers
 - Chapter 2D—Guide Signs for Conventional Roads
 - Chapter 2E—Guide Signs for Freeways and Expressways
 - Chapter 2F—Toll Road Signs
 - Chapter 2G—Preferential and Managed Lane Signs
 - Chapter 2H—General Information Signs
 - Chapter 2I—General Service Signs
 - Chapter 2J—Specific Service (Logo) Signs
 - Chapter 2K—Tourist-Oriented Direction Signs
 - Chapter 2L—Changeable Message Signs
 - Chapter 2M—Recreational and Cultural Interest Area Signs
 - Chapter 2N—Emergency Management Signs

Standard:

- 03 **Because the requirements and standards for signs depend on the particular type of highway upon which they are to be used, the definitions for freeway, expressway, conventional road, and special purpose road given in Section 1A.13 shall apply in Part 2.**

Section 2A.02 Definitions

Support:

- 01 Definitions and acronyms that are applicable to signs are given in Sections 1A.13 and 1A.14.

Section 2A.03 Standardization of Application

Support:

- 01 It is recognized that urban traffic conditions differ from those in rural environments, and in many instances signs are applied and located differently. Where pertinent and practical, this Manual sets forth separate recommendations for urban and rural conditions.

Guidance:

- 02 *Signs should be used only where justified by engineering judgment or studies, as provided in Section 1A.09.*
- 03 *Results from traffic engineering studies of physical and traffic factors should indicate the locations where signs are deemed necessary or desirable.*
- 04 *Roadway geometric design and sign application should be coordinated so that signing can be effectively placed to give the road user any necessary regulatory, warning, guidance, and other information.*

Standard:

- 05 **Each standard sign shall be displayed only for the specific purpose as prescribed in this Manual. Determination of the particular signs to be applied to a specific condition shall be made in accordance with the provisions set forth in Part 2. Before any new highway, private road open to public travel (see definition in Section 1A.13), detour, or temporary route is opened to public travel, all necessary signs shall be in place. Signs required by road conditions or restrictions shall be removed when those conditions cease to exist or the restrictions are withdrawn.**

Section 2A.04 Excessive Use of Signs

Guidance:

- 01 *Regulatory and warning signs should be used conservatively because these signs, if used to excess, tend to lose their effectiveness. If used, route signs and directional guide signs should be used frequently because their use promotes efficient operations by keeping road users informed of their location.*

Section 2A.05 Classification of Signs

Standard:

- 01 **Signs shall be defined by their function as follows:**
- A. **Regulatory signs give notice of traffic laws or regulations.**
 - B. **Warning signs give notice of a situation that might not be readily apparent.**
 - C. **Guide signs show route designations, destinations, directions, distances, services, points of interest, and other geographical, recreational, or cultural information.**

Support:

- 02 Object markers are defined in Section 2C.63.

Section 2A.06 Design of Signs

Support:

- 01 This Manual shows many typical standard signs and object markers approved for use on streets, highways, bikeways, and pedestrian crossings.
- 02 In the specifications for individual signs and object markers, the general appearance of the legend, color, and size are shown in the accompanying tables and illustrations, and are not always detailed in the text.
- 03 Detailed drawings of standard signs, object markers, alphabets, symbols, and arrows (see Figure 2D-2) are shown in the “Sign Designs and Markings Manual (SDMM)” published by ODOT. Section 1A.11 contains information regarding how to obtain this publication.
- 04 The basic requirements of a sign are that it be legible to those for whom it is intended and that it be understandable in time to permit a proper response. Desirable attributes include:
- A. High visibility by day and night; and
 - B. High legibility (adequately sized letters, symbols, or arrows, and a short legend for quick comprehension by a road user approaching a sign).
- 05 Standardized colors and shapes are specified so that the several classes of traffic signs can be promptly recognized. Simplicity and uniformity in design, position, and application are important.

Standard:

- 06 **The term legend shall include all word messages and symbol and arrow designs that are intended to convey specific meanings.**
- 07 **Uniformity in design shall include shape, color, dimensions, legends, borders, and illumination or retroreflectivity.**
- 08 **Standardization of these designs does not preclude further improvement by minor changes in the proportion or orientation of symbols, width of borders, or layout of word messages, but all shapes and colors shall be as indicated.**
- 09 **All symbols shall be unmistakably similar to, or mirror images of, the adopted symbol signs, all of which are shown in the “Sign Designs and Markings Manual (SDMM)” (see Section 1A.11). Symbols and colors shall not be modified unless otherwise provided in this Manual. All symbols and colors for signs not shown in the SDMM shall follow the procedures for experimentation and change described in Section 1A.10.**

Support:

- 10 The symbols in the SDMM conform to the symbols in the “Standard Highway Signs and Markings” book published by the Federal Highway Administration (FHWA).

Option:

- 11 Although the standard design of symbol signs cannot be modified, the orientation of the symbol may be changed to better reflect the direction of travel, if appropriate.

Standard:

- 12 **Where a standard word message is applicable, the wording shall be as provided in this Manual.**

- 13 **In situations where word messages are required other than those provided in this Manual, the signs shall be of the same shape and color as standard signs of the same functional type.**

Option:

- 14 Highway agencies may develop special word message signs in situations where roadway conditions make it necessary to provide road users with additional regulatory, warning, or guidance information, such as when road users need to be notified of special regulations or warned about a situation that might not be readily apparent. Unlike colors that have not been assigned or symbols that have not been approved for signs, new word message signs may be used without the need for experimentation.

Standard:

- 15 **Except as provided in Paragraph 17 and except for the Carpool Information (D12-2) sign (see Section 2I.11), Internet addresses and e-mail addresses, including domain names and uniform resource locators (URL), shall not be displayed on any sign, supplemental plaque, sign panel (including logo sign panels on Specific Service signs), or changeable message sign.**

Guidance:

- 16 *Unless otherwise provided in this Manual or shown in the SDMM for a specific sign, and except as provided in Paragraph 17, telephone numbers of more than four characters should not be displayed on any sign, supplemental plaque, sign panel (including logo sign panels on specific service signs), or changeable message sign.*

Option:

- 17 Internet addresses, e-mail addresses, or telephone numbers with more than four characters may be displayed on signs, supplemental plaques, sign panels, and changeable message signs that are intended for viewing only by pedestrians, bicyclists, occupants of parked vehicles, or drivers of vehicles on low-speed roadways where engineering judgment indicates that an area is available for drivers to stop out of the traffic flow to read the message.

Standard:

- 18 **Pictographs (see definition in Section 1A.13) shall not be displayed on signs except as specifically provided in this Manual. Pictographs shall be simple, dignified, and devoid of any advertising. When used to represent a political jurisdiction (such as a State, county, or municipal corporation) the pictograph shall be the official designation adopted by the jurisdiction. When used to represent a college or university, the pictograph shall be the official seal adopted by the institution. Pictorial representations of university or college programs shall not be permitted to be displayed on a sign.**

Section 2A.07 Retroreflectivity and Illumination

Support:

- 01 There are many materials currently available for retroreflection and various methods currently available for the illumination of signs and object markers. New materials and methods continue to emerge. New materials and methods can be used as long as the signs and object markers meet the standard requirements for color, both by day and by night.

Standard:

- 02 **Regulatory, warning, and guide signs and object markers shall be retroreflective (see Section 2A.08) or illuminated to show the same shape and similar color by both day and night, unless otherwise provided in the text discussion in this Manual for a particular sign or group of signs.**

- 03 **The requirements for sign illumination shall not be considered to be satisfied by street or highway lighting.**

Option:

- 04 Sign elements may be illuminated by the means shown in Table 2A-1.

05 Retroreflection of sign elements may be accomplished by the means shown in Table 2A-2.

06 Light Emitting Diode (LED) units may be used individually within the legend of a sign and in the border of a sign, except for changeable message signs, to improve the conspicuity, increase the legibility of sign legends and borders, or provide a changeable message.

Standard:

07 **Except as provided in Paragraphs 11 and 12, neither individual LEDs nor groups of LEDs shall be placed within the background area of a sign.**

08 **If used, the LEDs shall have a maximum diameter of 1/4 inch and shall be the following colors based on the type of signs:**

- A. White or red, if used with STOP or YIELD signs.
- B. White, if used with regulatory signs other than STOP or YIELD signs.
- C. White or yellow, if used with warning signs.
- D. White, if used with guide signs.
- E. White, yellow, or orange, if used with temporary traffic control signs.
- F. White or yellow, if used with school area signs.

09 **If flashed, all LED units shall flash simultaneously at a rate of more than 50 and less than 60 times per minute.**

10 **The uniformity of the sign design shall be maintained without any decrease in visibility, legibility, or driver comprehension during either daytime or nighttime conditions.**

Option:

11 For STOP and YIELD signs, LEDs may be placed within the border or within one border width within the background of the sign.

12 For STOP/SLOW paddles (see Section 6E.03) used by flaggers and the STOP paddles (see Section 7D.05) used by adult crossing guards, individual LEDs or groups of LEDs may be used.

Support:

13 Other methods of enhancing the conspicuity of standard signs are described in Section 2A.15.

14 Information regarding the use of retroreflective material on the sign support is contained in Section 2A.21.

Table 2A-1. Illumination of Sign Elements

Means of Illumination	Sign Element To Be Illuminated
Light behind the sign face	<ul style="list-style-type: none"> • Symbol or word message • Background • Symbol, word message, and background (through a translucent material)
Attached or independently mounted light source designed to direct essentially uniform illumination onto the sign face	<ul style="list-style-type: none"> • Entire sign face
Light emitting diodes (LEDs)	<ul style="list-style-type: none"> • Symbol or word message • Portions of the sign border
Other devices, or treatments that highlight the sign shape, color, or message: Luminous tubing Fiber optics Incandescent light bulbs Luminescent panels	<ul style="list-style-type: none"> • Symbol or word message • Entire sign face

Table 2A-2. Retroreflection of Sign Elements

Means of Retroreflection	Sign Element
Reflector “buttons” or similar units	Symbol Word Message Border
A material that has a smooth, sealed outer surface over a microstructure that reflects light	Symbol Word Message Border Background

Section 2A.08 Maintaining Minimum Retroreflectivity

Support:

01 Retroreflectivity is one of several factors associated with maintaining nighttime sign visibility (see Section 2A.22).

Standard:

02 **Public agencies or officials having jurisdiction shall use an assessment or management method that is designed to maintain sign retroreflectivity at or above the minimum levels in Table 2A-3.**

Support:

03 Compliance with the Standard in Paragraph 2 is achieved by having a method in place and using the method to maintain the minimum levels established in Table 2A-3. Provided that an assessment or management method is being used, an agency or official having jurisdiction would be in compliance with the Standard in Paragraph 2 even if there are some individual signs that do not meet the minimum retroreflectivity levels at a particular point in time.

Guidance:

04 *Except for those signs specifically identified in Paragraph 6, one or more of the following assessment or management methods should be used to maintain sign retroreflectivity:*

- A. *Visual Nighttime Inspection—The retroreflectivity of an existing sign is assessed by a trained sign inspector conducting a visual inspection from a moving vehicle during nighttime conditions. Signs that are visually identified by the inspector to have retroreflectivity below the minimum levels should be replaced.*
- B. *Measured Sign Retroreflectivity—Sign retroreflectivity is measured using a retroreflectometer. Signs with retroreflectivity below the minimum levels should be replaced.*
- C. *Expected Sign Life—When signs are installed, the installation date is labeled or recorded so that the age of a sign is known. The age of the sign is compared to the expected sign life. The expected sign life is based on the experience of sign retroreflectivity degradation in a geographic area compared to the minimum levels. Signs older than the expected life should be replaced.*
- D. *Blanket Replacement—All signs in an area/corridor, or of a given type, should be replaced at specified intervals. This eliminates the need to assess retroreflectivity or track the life of individual signs. The replacement interval is based on the expected sign life, compared to the minimum levels, for the shortest-life material used on the affected signs.*
- E. *Control Signs—Replacement of signs in the field is based on the performance of a sample of control signs. The control signs might be a small sample located in a maintenance yard or a sample of signs in the field. The control signs are monitored to determine the end of retroreflective life for the associated signs. All field signs represented by the control sample should be replaced before the retroreflectivity levels of the control sample reach the minimum levels.*
- F. *Other Methods—Other methods developed based on engineering studies can be used.*

Support:

05 Additional information about these methods is contained in the 2007 Edition of FHWA’s “Maintaining Traffic Sign Retroreflectivity” (see Section 1A.11).

Table 2A-3. Minimum Maintained Retroreflectivity Levels¹

Sign Color	Sheeting Type (ASTM D4956-04)**				Additional Criteria
	Beaded Sheeting		Prismatic Sheeting		
	I	II	III	III, IV, VI, VII, VIII, IX, X	
White On Green	W*; G ≥ 7	W*; G ≥ 15	W*; G ≥ 25	W ≥ 250; G ≥ 25	Overhead
	W*; G ≥ 7	W ≥ 120; G ≥ 15			Post-mounted
Black on Yellow or Black on Orange	Y*; O*	Y ≥ 50; O ≥ 50			2
	Y*; O*	Y ≥ 75; O ≥ 75			3
White on Red	W ≥ 35; R ≥ 7				4
Black on White	W ≥ 50				–
¹ The minimum maintained retroreflectivity levels shown in this table are in units of cd/lx/m ² measured at an observation angle of 0.2° and an entrance angle of -4.0°.					
² For text and fine symbol signs measuring at least 48 inches and for all sizes of bold symbol signs					
³ For text and fine symbol signs measuring less than 48 inches					
⁴ Minimum Sign Contrast Ratio ≥ 3:1 (white retroreflectivity ÷ red retroreflectivity)					
* This sheeting type shall not be used for this color for this application.					
Bold Symbol Signs					
<ul style="list-style-type: none"> • W1-1,2 – Turn and Curve • W1-3,4 – Reverse Turn and Curve • W1-5 – Winding Road • W1-6,7 – Large Arrow • W1-8 – Chevron • W1-10 – Intersection in Curve • W1-11 – Hairpin Curve • W1-15 – 270 Degree Loop • W2-1 – Cross Road • W2-2,3 – Side Road • W2-4,5 – T and Y Intersection • W2-6 – Circular Intersection • W2-7,8 – Double Side Roads 		<ul style="list-style-type: none"> • W3-1 – Stop Ahead • W3-2 – Yield Ahead • W3-3 – Signal Ahead • W4-1 – Merge • W4-2 – Lane Ends • W4-3 – Added Lane • W4-5 – Entering Roadway Merge • W4-6 – Entering Roadway Added Lane • W6-1,2 – Divided Highway Begins and Ends • W6-3 – Two-Way Traffic • W10-1,2,3,4,11,12 – Grade Crossing Advance Warning 		<ul style="list-style-type: none"> • W11-2 – Pedestrian Crossing • W11-3,4,16-22 – Large Animals • W11-5 – Farm Equipment • W11-6 – Snowmobile Crossing • W11-7 – Equestrian Crossing • W11-8 – Fire Station • W11-10 – Truck Crossing • W12-1 – Double Arrow • W16-5P,6P,7P – Pointing Arrow Plaques • W20-7 – Flagger • W21-1 – Worker 	
Fine Symbol Signs (symbol signs not listed as bold symbol signs)					
Special Cases					
<ul style="list-style-type: none"> • W3-1 – Stop Ahead: Red retroreflectivity ≥ 7 • W3-2 – Yield Ahead: Red retroreflectivity ≥ 7; White retroreflectivity ≥ 35 • W3-3 – Signal Ahead: Red retroreflectivity ≥ 7; Green retroreflectivity ≥ 7 • W3-5 – Speed Reduction: White retroreflectivity ≥ 50 • For non-diamond shaped signs, such as W14-3 (No Passing Zone), W4-4p (Cross Traffic Does Not Stop), or W13-1P,2,3,6,7 (Speed Advisory Plaques), use largest sign dimension to determine proper minimum retroreflectivity level. 					

** There is a 2009 version of this ASTM standard available that may have additional information available.

Option:

- 06 Highway agencies may exclude the following signs from the retroreflectivity maintenance guidelines described in this Section:
- A. Parking, Standing, and Stopping signs (R7 and R8 series)
 - B. Walking/Hitchhiking/Crossing signs (R9 series, R10-1 through R10-4b)
 - C. Acknowledgment signs (see Section 2H.08)
 - D. All signs with blue or brown backgrounds
 - E. Bikeway signs that are intended for exclusive use by bicyclists or pedestrians

Section 2A.09 Shapes

Standard:

- 01 **Particular shapes, as shown in Table 2A-4, shall be used exclusively for specific signs or series of signs, unless otherwise provided in the text discussion in this Manual for a particular sign or class of signs.**

Section 2A.10 Sign Colors

Standard:

- 01 **The colors to be used on standard signs and their specific use on these signs shall be as provided in the applicable Sections of this Manual. The color coordinates and values shall be as described in 23 CFR, Part 655, Subpart F, Appendix.**

Support:

- 02 As a quick reference, common uses of sign colors are shown in Table 2A-5. Color schemes on specific signs are shown in the illustrations located in each appropriate Chapter.
- 03 Whenever white is specified in this Manual or in the "Sign Designs and Markings Manual" (SDMM) (see Section 1A.11) as a color, it is understood to include silver-colored retroreflective coatings or elements that reflect white light.
- 04 The colors coral and light blue are being reserved for uses that will be determined in the future by the Federal Highway Administration.
- 05 Information regarding color coding of destinations on guide signs, including community wayfinding signs, is contained in Chapter 2D.

Option:

- 06 The approved fluorescent version of the standard red, yellow, green, or orange color may be used as an alternative to the corresponding standard color.

Section 2A.11 Dimensions

Support:

- 01 The SDMM (see Section 1A.11) prescribes design details for various sizes depending on the type of traffic facility, including bikeways. Smaller sizes are designed to be used on bikeways and some other off-road applications. Larger sizes are designed for use on freeways and expressways, and can also be used to enhance road user safety and convenience on other facilities, especially on multi-lane divided highways and on undivided highways having five or more lanes of traffic and/or high speeds. The intermediate sizes are designed to be used on other highway types.

Standard:

- 02 **The sign dimensions prescribed in the sign size tables in the various Parts and Chapters in this Manual and in the SDMM (see Section 1A.11) shall be used unless engineering judgment determines that other sizes are appropriate. Except as provided in Paragraph 3, where engineering judgment determines that sizes smaller than the prescribed dimensions are appropriate for use, the sign dimensions shall not be less than the minimum dimensions specified in this Manual. The sizes shown in the Minimum columns that are smaller than the sizes shown in the Conventional Road columns in the various sign size tables in this Manual shall only be used on low-speed roadways, alleys, and private roads open to public travel where the reduced legend size would be adequate for the regulation or warning or where physical conditions preclude the use of larger sizes.**

03 For alleys with restrictive physical conditions and vehicle usage that limits installation of the Minimum size sign (or the Conventional Road size sign if no Minimum size is shown), both the sign height and the sign width may be decreased by up to 6 inches.

Guidance:

04 *The sizes shown in the Freeway and Expressway columns in the various sign size tables in this Manual should be used on freeways and expressways, and for other higher-speed applications based upon engineering judgment, to provide larger signs for increased visibility and recognition.*

05 *The sizes shown in the Oversized columns in the various sign size tables in this Manual size should be used for those special applications where speed, volume, or other factors result in conditions where increased emphasis, improved recognition, or increased legibility is needed, as determined by engineering judgment or study.*

06 *Increases above the prescribed sizes should be used where greater legibility or emphasis is needed. If signs larger than the prescribed sizes are used, the overall sign dimensions should be increased in 6-inch increments.*

Standard:

07 **Where engineering judgment determines that sizes that are different than the prescribed dimensions are appropriate for use, standard shapes and colors shall be used and standard proportions shall be retained as much as practical.**

Guidance:

08 *When supplemental plaques are installed with larger sized signs, a corresponding increase in the size of the plaque and its legend should also be made. The resulting plaque size should be approximately in the same relative proportion to the larger sized sign as the conventional sized plaque is to the conventional sized sign.*

Table 2A-4. Use of Sign Shapes

Shape	Signs
Octagon	Stop*
Equilateral Triangle (1 point down)	Yield*
Circle	Grade Crossing Advance Warning*
Pennant Shape/Isosceles Triangle (longer axis horizontal)	No Passing*
Pentagon (pointed up)	School Advance Warning Sign (squared bottom corners)* County Route Sign*
Crossbuck (two rectangles in an "X" configuration)	Grade Crossing*
Diamond	Warning Series
Rectangle (including square)	Regulatory Series Guide Series** Warning Series
Trapezoid	Recreational and Cultural Interest Area Series National Forest Route Sign

* This sign shall be exclusively the shape shown.

** Guide series includes general service, specific service, tourist-oriented directional, general information, recreational and cultural interest area, and emergency management signs.

Table 2A-5. Common Uses of Sign Colors

Type of Sign	Legend								Background											
	Black	Green	Red	White	Yellow	Orange	Fluorescent Yellow-Green	Fluorescent Pink	Black	Blue	Brown	Green	Orange ¹	Red ¹	White	Yellow ¹	Purple	Fluorescent Yellow-Green	Fluorescent Pink	
Regulatory	X		X	X					X					X	X					
Prohibitive			X	X										X	X					
Permissive		X													X					
Warning	X															X				
Pedestrian	X															X			X	
Bicycle	X															X			X	
Guide				X							X									
Interstate Route				X						X				X						
State Route	X														X					
U.S. Route	X														X					
County Route					X					X										
Forest Route				X							X									
Street Name				X								X								
Destination				X								X								
Reference Location				X								X								
Information				X						X	X									
Evacuation Route				X						X										
Road User Service				X						X										
Recreational				X							X	X								
Temporary Traffic Control	X											X								
Incident Management	X											X								X
School	X																			X
ETC-Account Only	X																X ³			
Changeable Message Sign																				
Regulatory			X ³	X					X											
Warning					X				X											
Temporary Traffic Control					X	X			X											
Guide				X					X			X ²								
Motorist Services				X					X	X ²										
Incident Management					X		X		X											
School, Pedestrian, Bicycle					X		X		X											

¹ Fluorescent versions of these background colors may also be used.
² These alternative background colors would be provided by blue or green lighted pixels such that the entire CMS would be lighted, not just the legend.
³ Red is used only for the circle and slash or other red elements of a similar static regulatory sign.
⁴ The use of the color purple on signs is restricted per the provisions of Paragraph 1 of Section 2F.03.

Section 2A.12 Symbols**Standard:**

01 **Symbol designs shall in all cases be unmistakably similar to those shown in this Manual and in the SDMM (see Section 1A.11).**

Support:

02 New symbol designs are adopted by the Federal Highway Administration based on research evaluations to determine road user comprehension, sign conspicuity, and sign legibility.

03 Sometimes a change from word messages to symbols requires significant time for public education and transition. Therefore, this Manual sometimes includes the practice of using educational plaques to accompany new symbol signs.

Guidance:

04 *New warning or regulatory symbol signs not readily recognizable by the public should be accompanied by an educational plaque.*

Option:

05 Educational plaques may be left in place as long as they are in serviceable condition.

06 Highway agencies may conduct research studies to determine road user comprehension, sign conspicuity, and sign legibility.

Guidance:

07 *Although most standard symbols are oriented facing left, mirror images of these symbols should be used where the reverse orientation might better convey to road users a direction of movement.*

Standard:

08 **A symbol used for a given category of signs (regulatory, warning, or guide) shall not be used for a different category of signs, except as specifically authorized in this Manual.**

09 **Except as provided in Paragraph 11, a recreational and cultural interest area symbol (see Chapter 2M) shall not be used on streets or highways outside of recreational and cultural interest areas.**

10 **A recreational and cultural interest area guide sign symbol (see Chapter 2M) shall not be used on any regulatory or warning sign on any street, road, or highway.**

Option:

11 A recreational and cultural interest area guide sign symbol (see Section 2M.04) may be used on a highway guide sign outside of a recreational and cultural interest area to supplement a comparable word message for which there is no approved symbol for that message in Chapters 2B through 2I or 2N.

Support:

12 Section 2M.07 contains provisions for the use of recreational and cultural interest area symbols to indicate prohibited activities or items in non-road applications.

Section 2A.13 Word Messages**Standard:**

01 **Except as provided in Section 2A.06, all word messages shall use standard wording and letters as shown in this Manual and the SDMM (see Section 1A.11).**

Guidance:

02 *Word messages should be as brief as possible and the lettering should be large enough to provide the necessary legibility distance. A minimum specific ratio of 1 inch of letter height per 30 feet of legibility distance should be used.*

03 *Abbreviations (see Section 1A.14) should be kept to a minimum.*

04 *Word messages should not contain periods, apostrophes, question marks, ampersands, or other punctuation or characters that are not letters, numerals, or hyphens unless necessary to avoid confusion.*

05 *The solidus (slanted line or forward slash) is intended to be used for fractions only and should not be used to separate words on the same line of legend. Instead, a hyphen should be used for this purpose, such as "TRUCKS - BUSES."*

Standard:

- 06 **Fractions shall be displayed with the numerator and denominator diagonally arranged about the solidus (slanted line or forward slash). The overall height of the fraction is measured from the top of the numerator to the bottom of the denominator, each of which is vertically aligned with the upper and lower ends of the solidus. The overall height of the fraction shall be determined by the height of the numerals within the fraction, and shall be 1.5 times the height of an individual numeral within the fraction.**

Support:

- 07 The SDMM (see Section 1A.11) contains details regarding the layouts of fractions on signs.

Guidance:

- 08 *When initials are used to represent an abbreviation for separate words (such as “U S” for a United States route), the initials should be separated by a space of between 1/2 and 3/4 of the letter height of the initials.*

- 09 *When an Interstate route is displayed in text form instead of using the route shield, a hyphen should be used for clarity, such as “I-50.”*

Standard:

- 10 **All sign lettering shall be in upper-case letters as provided in the SDMM, unless otherwise provided in this Manual for a particular sign or type of message.**

- 11 **The sign lettering for names of places, streets, and highways shall be composed of a combination of lower-case letters with initial upper-case letters.**

Support:

- 12 Letter height is expressed in terms of the height of an upper-case letter. For mixed-case legends (those composed of an initial upper-case letter followed by lower-case letters), the height of the lower-case letters is derived from the specified height of the initial upper-case letter based on a prescribed ratio. Letter heights for mixed-case legends might be expressed in terms of both the upper- and lower-case letters, or in terms of the initial upper-case letter alone. When the height of a lower-case letter is specified or determined from the prescribed ratio, the reference is to the nominal loop height of the letter. The term loop height refers to the portion of a lower-case letter that excludes any ascending or descending stems or tails of the letter, such as with the letters “d” or “q.” The nominal loop height is equal to the actual height of a non-rounded lower-case letter whose form does not include ascending or descending stems or tails, such as the letter “x.” The rounded portions of a lower-case letter extend slightly above and below the baselines projected from the top and bottom of such a non-rounded letter so that the appearance of a uniform letter height within a word is achieved. The actual loop height of a rounded lower-case letter is slightly greater than the nominal loop height and this additional height is excluded from the expression of the lower-case letter height.

Standard:

- 13 **When a mixed-case legend is used, the height of the lower-case letters shall be 3/4 of the height of the initial upper-case letter.**

- 14 **The unique letter forms for each of the Standard Alphabet series shall not be stretched, compressed, warped, or otherwise manipulated.**

Support:

- 15 Section 2D.04 contains information regarding the acceptable methods of modifying the length of a word for a given letter height and series.

Section 2A.14 Sign Borders**Standard:**

- 01 **Unless otherwise provided, each sign illustrated in this Manual shall have a border of the same color as the legend, at or just inside the edge.**

- 02 **The corners of all sign borders shall be rounded, except for STOP signs.**

Guidance:

- 03 *A dark border on a light background should be set in from the edge, while a light border on a dark background should extend to the edge of the sign. A border for 30-inch signs with a light background should*

be from 1/2 to 3/4 inch in width, 1/2 inch from the edge. For similar signs with a light border, a width of 1 inch should be used. For other sizes, the border width should be of similar proportions, but should not exceed the stroke-width of the major lettering of the sign. On signs exceeding 72 x 120 inches in size, the border should be 2 inches wide, or on larger signs, 3 inches wide. Except for STOP signs and as otherwise provided in Section 2E.16, the corners of the sign should be rounded to a radius that is concentric with that of the border.

Section 2A.15 Enhanced Conspicuity for Standard Signs

Option:

- 01 Based upon engineering judgment, where the improvement of the conspicuity of a standard regulatory, warning, or guide sign is desired, any of the following methods may be used, as appropriate, to enhance the sign's conspicuity (see Figure 2A-1):
- A. Increasing the size of a standard regulatory, warning, or guide sign.
 - B. Doubling-up of a standard regulatory, warning, or guide sign by adding a second identical sign on the left-hand side of the roadway.
 - C. Adding a solid yellow or fluorescent yellow rectangular "header panel" above a standard regulatory sign, with the width of the panel corresponding to the width of the standard regulatory sign. A legend of "NOTICE," "STATE LAW," or other appropriate text may be added in black letters within the header panel for a period of time determined by engineering judgment.
 - D. Adding a NEW plaque (see Section 2C.62) above a new standard regulatory or warning sign, for a period of time determined by engineering judgment, to call attention to the new sign.
 - E. Adding one or more red or orange flags (cloth or retroreflective sheeting) above a standard regulatory or warning sign, with the flags oriented so as to be at 45 degrees to the vertical.
 - F. Adding a solid yellow, a solid fluorescent yellow, or a diagonally striped black and yellow (or black and fluorescent yellow) strip of retroreflective sheeting at least 3 inches wide around the perimeter of a standard warning sign. This may be accomplished by affixing the standard warning sign on a background that is 6 inches larger than the size of the standard warning sign.
 - G. Adding a warning beacon (see Section 4L.03) to a standard regulatory (other than a STOP or a Speed Limit sign), warning, or guide sign.
 - H. Adding a speed limit sign beacon (see Section 4L.04) to a standard Speed Limit sign.
 - I. Adding a stop beacon (see Section 4L.05) to a STOP sign.
 - J. Adding light emitting diode (LED) units within the symbol or legend of a sign or border of a standard regulatory, warning, or guide sign, as provided in Section 2A.07.
 - K. Adding a strip of retroreflective material to the sign support in compliance with the provisions of Section 2A.21.
 - L. Using other methods that are specifically allowed for certain signs as described elsewhere in this Manual.

Support:

- 02 Sign conspicuity improvements can also be achieved by removing non-essential and illegal signs from the right-of-way (see Section 1A.08), and by relocating signs to provide better spacing.

Standard:

- 03 **The NEW plaque (see Section 2C.62) shall not be used alone.**
- 04 **Strobe lights shall not be used to enhance the conspicuity of highway signs.**

Section 2A.16 Standardization of Location

Support:

- 01 Standardization of position cannot always be attained in practice. Examples of heights and lateral locations of signs for typical installations are illustrated in Figure 2A-2, and examples of locations for some typical signs at intersections are illustrated in Figures 2A-3 and 2A-4.

- 02 Examples of advance signing on an intersection approach are illustrated in Figure 2A-4. Chapters 2B, 2C, and 2D contain provisions regarding the application of regulatory, warning, and guide signs, respectively.

Figure 2A-1. Examples of Enhanced Conspicuity for Signs

A – W16-15P plaque above a regulatory or warning sign if the regulation or condition is new



B – Red or orange flags above a regulatory, warning, or guide sign



C – W16-18P plaque above a regulatory sign



D – Solid yellow, solid fluorescent yellow, or diagonally striped black and yellow (or black and fluorescent yellow) strip of retroreflective sheeting around a warning sign



E – Vertical retroreflective strip on sign support



F – Supplemental beacon



Standard:

- 03 Signs requiring separate decisions by the road user shall be spaced sufficiently far apart for the appropriate decisions to be made. One of the factors considered when determining the appropriate spacing shall be the posted or 85th-percentile speed.

Guidance:

- 04 Signs should be located on the right-hand side of the roadway where they are easily recognized and understood by road users. Signs in other locations should be considered only as supplementary to signs in the normal locations, except as otherwise provided in this Manual.
- 05 Signs should be individually installed on separate posts or mountings except where:
- A. One sign supplements another, or
 - B. Route or directional signs are grouped to clarify information to motorists, or
 - C. Regulatory signs that do not conflict with each other are grouped, such as turn prohibition signs posted with ONE WAY signs or a parking regulation sign posted with a Speed Limit sign.
 - D. Street Name signs are posted with a STOP or YIELD sign.
- 06 Signs should be located so that they:
- A. Are outside the clear zone unless placed on a breakaway or yielding support (see Section 2A.19);
 - B. Optimize nighttime visibility;
 - C. Minimize the effects of mud splatter and debris;

Figure 2A-2. Examples of Heights and Lateral Locations of Sign Installations

A - ROADSIDE SIGN IN RURAL AREA

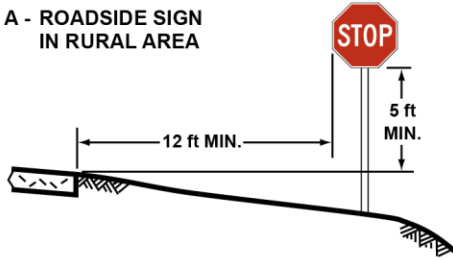

B - ROADSIDE SIGN IN RURAL AREA

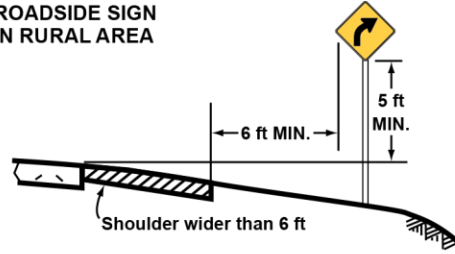

C - ROADSIDE SIGN IN BUSINESS, COMMERCIAL, OR RESIDENTIAL AREA

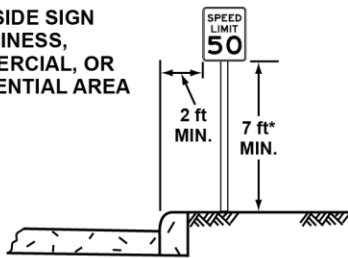

*Where parking or pedestrian movements are likely to occur

D - WARNING SIGN WITH ADVISORY SPEED PLAQUE IN RURAL AREA

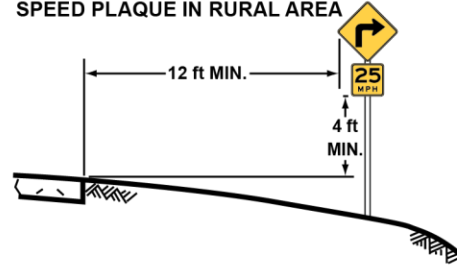

E - ROADSIDE ASSEMBLY IN RURAL AREA

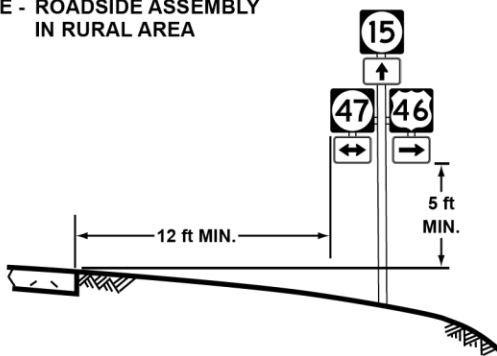

F - SIGN ON NOSE OF MEDIAN

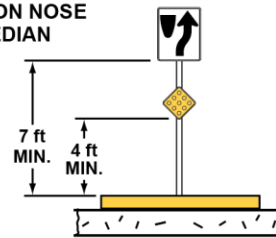

G - FREEWAY OR EXPRESSWAY SIGN WITH SECONDARY SIGN

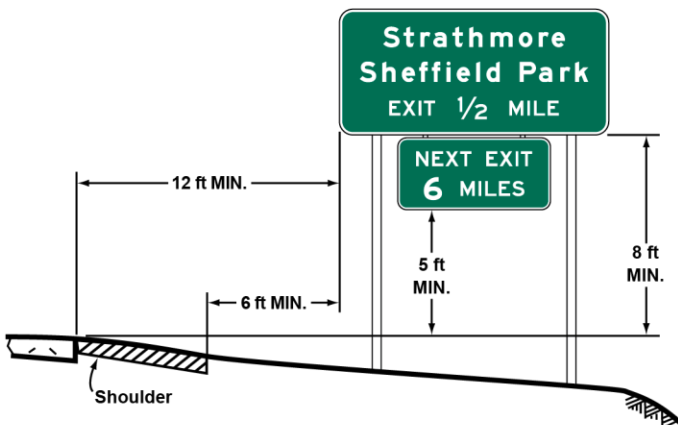

H - OVERHEAD SIGN

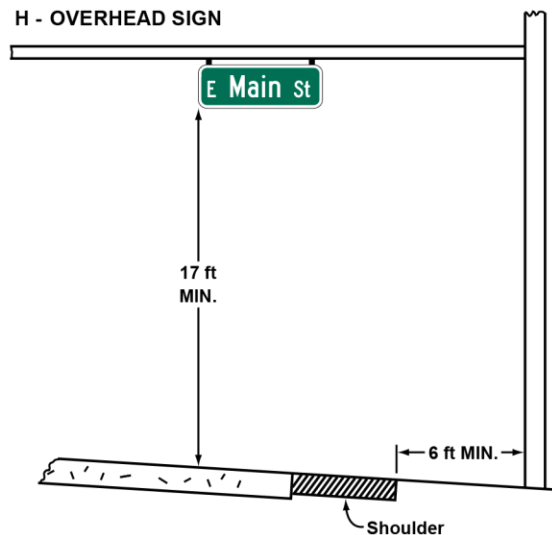

Note:

See Section 2A.19 for reduced lateral offset distances that may be used in areas where lateral offsets are limited, and in business, commercial, or residential areas where sidewalk width is limited or where existing poles are close to the curb.

Figure 2A-3. Examples of Locations for Some Typical Signs at Intersections

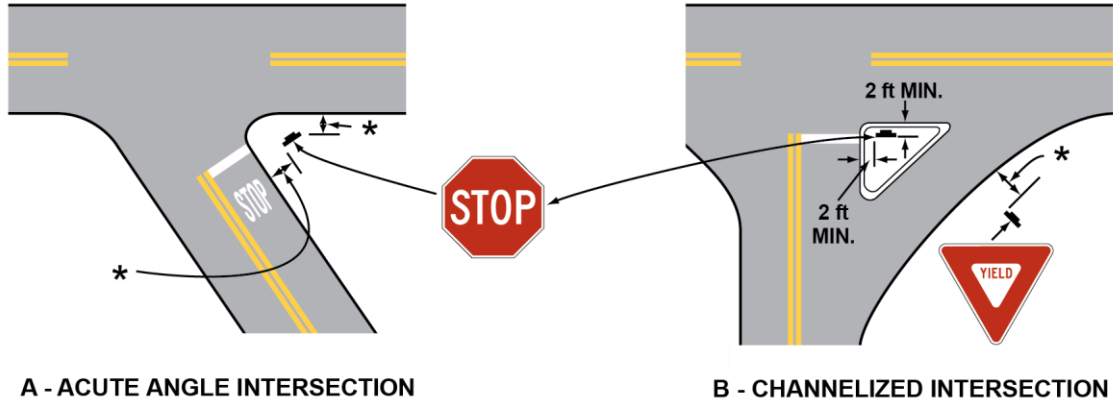

A - ACUTE ANGLE INTERSECTION

B - CHANNELIZED INTERSECTION

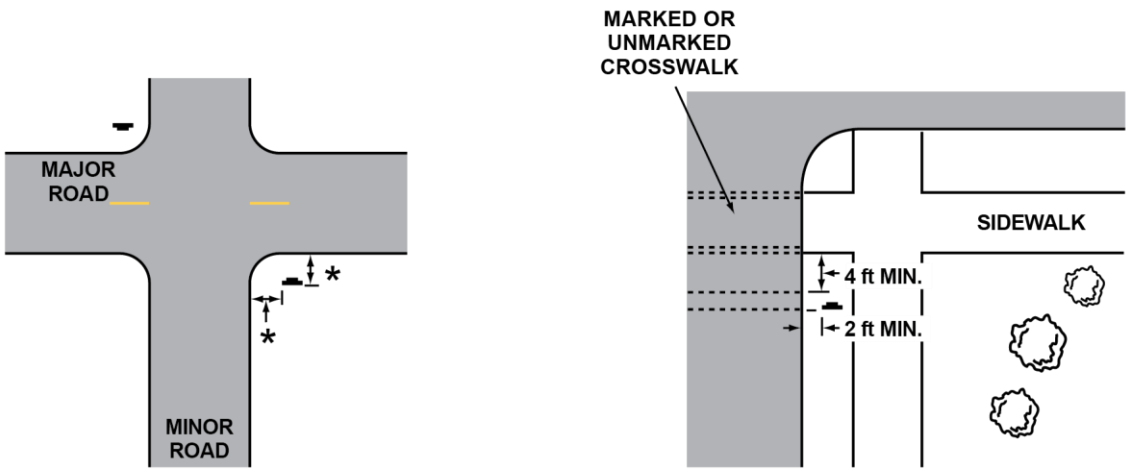

C - MINOR CROSSROAD

D - URBAN INTERSECTION

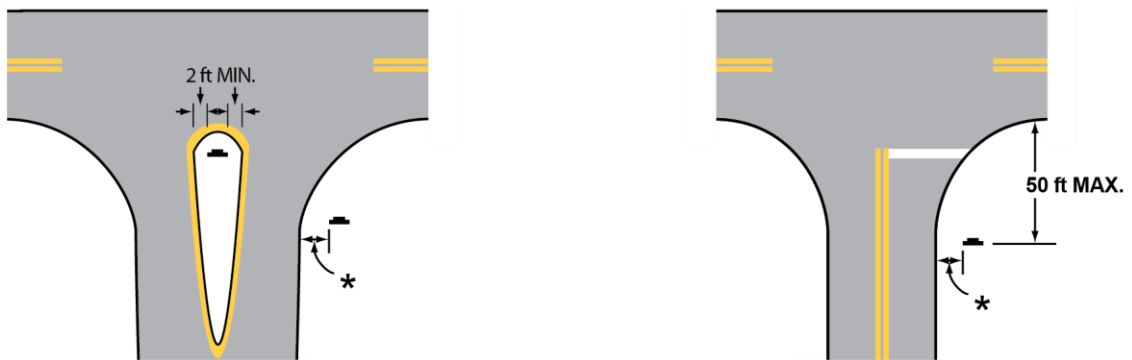

E - DIVISIONAL ISLAND

F - WIDE THROAT INTERSECTION

* Lateral offset is a minimum of 6 feet measured from the edge of the shoulder, or 12 feet measured from the edge of the traveled way. See Section 2A.19 for lower minimums that may be used in urban areas, or where lateral offset space is limited.

Figure 2A-4. Relative Locations of Regulatory, Warning, and Guide Signs on an Intersection Approach

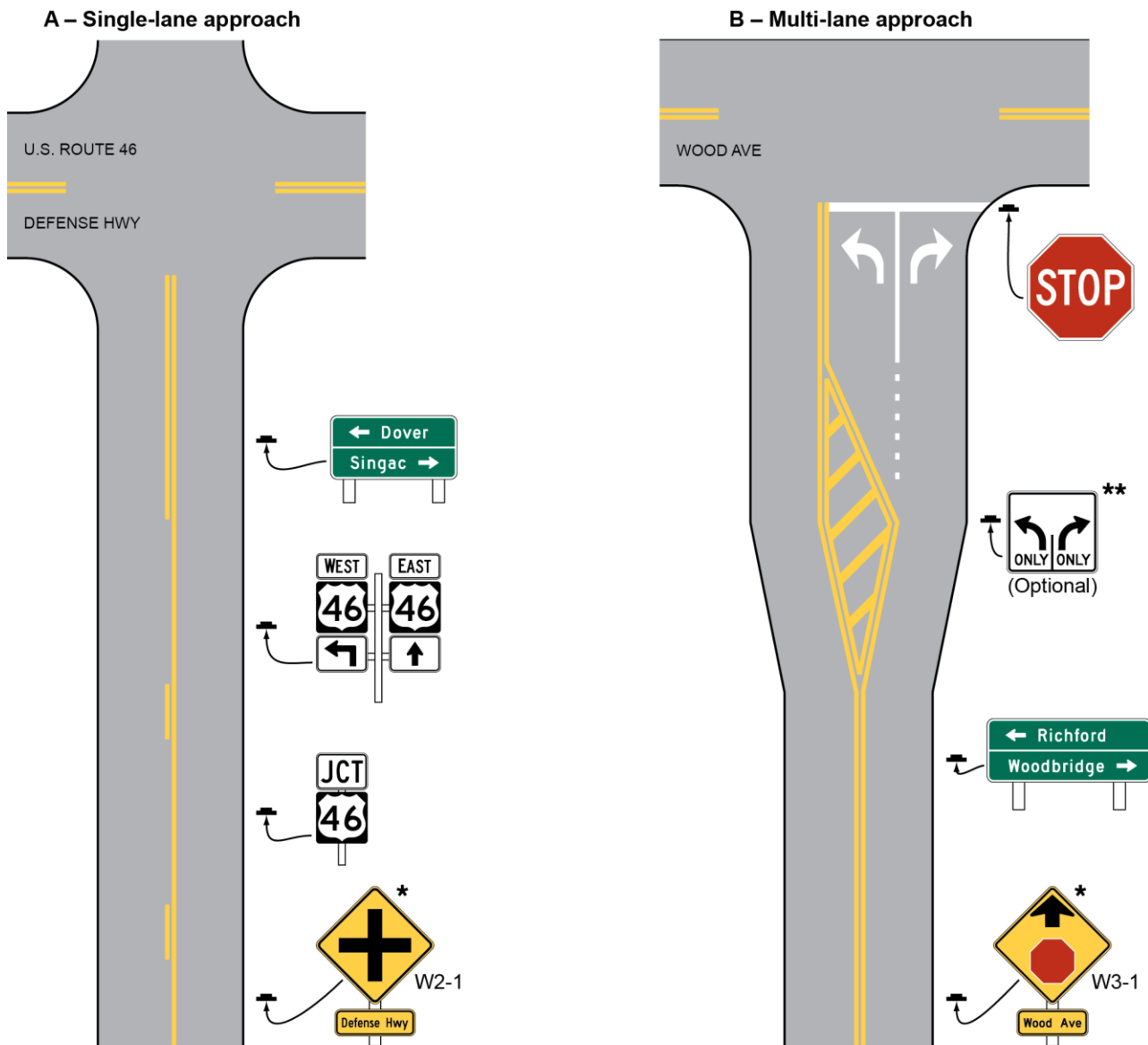

Note: See Chapter 2D for information on guide signs and Part 3 for information on pavement markings.

- * See Section 2C.46 for the application of the W2-1 sign and Section 2C.36 for the application of the W3-1 sign.
- ** See Section 2B.22 for the application of Intersection Lane Control signs.

- D. Do not obscure each other;
- E. Do not obscure the sight distance to approaching vehicles on the major street for drivers who are stopped on minor-street approaches, and
- F. Are not hidden from view.

Support:

07 The clear zone is the total roadside border area, starting at the edge of the traveled way, available for use by errant vehicles. The width of the clear zone is dependent upon traffic volumes, speeds, and roadside geometry. Additional information can be found in the “AASHTO Roadside Design Guide” (see the Preface for AASHTO’s address) and ODOT’s “Location and Design Manual, Volume One – Roadway Design” (see Section 1A.11).

Guidance:

- 08 *With the increase in traffic volumes and the desire to provide road users regulatory, warning, and guidance information, an order of priority for sign installation should be established.*

Support:

- 09 An order of priority is especially critical where space is limited for sign installation and there is a demand for several different types of signs. Overloading road users with too much information is not desirable.

Guidance:

- 10 *Because regulatory and warning information is more critical to the road user than guidance information, regulatory and warning signing whose location is critical should be displayed rather than guide signing in cases where conflicts occur. Community wayfinding and acknowledgment guide signs should have a lower priority as to placement than other guide signs. Information of a less critical nature should be moved to less critical locations or omitted.*

Option:

- 11 Under some circumstances, such as on curves to the right, signs may be placed on median islands or on the left-hand side of the road. A supplementary sign located on the left-hand side of the roadway may be used on a multi-lane road where traffic in a lane to the right might obstruct the view to the right.

Guidance:

- 12 *In urban areas where crosswalks exist, signs should not be placed within 4 feet in advance of the crosswalk (see Drawing D in Figure 2A-3).*

Section 2A.17 Overhead Sign Installations*Guidance:*

- 01 *Overhead signs should be used on freeways and expressways, at locations where some degree of lane-use control is desirable, and at locations where space is not available at the roadside.*

Support:

- 02 The operational requirements of the present highway system are such that overhead signs have value at many locations. The factors to be considered for the installation of overhead sign displays are not definable in specific numerical terms.

Option:

- 03 The following conditions (not in priority order) may be considered in an engineering study to determine if overhead signs would be beneficial:

- A. Traffic volume at or near capacity,
- B. Complex interchange design,
- C. Three or more lanes in each direction,
- D. Restricted sight distance,
- E. Closely spaced interchanges,
- F. Multi-lane exits,
- G. Large percentage of trucks,
- H. Street lighting background,
- I. High-speed traffic,
- J. Consistency of sign message location through a series of interchanges,
- K. Insufficient space for post-mounted signs,
- L. Junction of two freeways, and
- M. Left exit ramps.

- 04 Over-crossing structures may be used to support overhead signs.

Support:

- 05 Under some circumstances, the use of over-crossing structures as sign supports might be the only practical solution that will provide adequate viewing distance. The use of such structures as sign supports might eliminate the need for the foundations and sign supports along the roadside.

Section 2A.18 Mounting Height**Standard:**

01 **The provisions of this Section shall apply unless specifically stated otherwise for a particular sign or object marker elsewhere in this Manual.**

Support:

02 The mounting height requirements for object markers are provided in Chapter 2C.

03 In addition to the provisions of this Section, information affecting the minimum mounting height of signs as a function of crash performance can be found in AASHTO's "Roadside Design Guide" (see Section 1A.11).

Standard:

04 **The minimum height, measured vertically from the bottom of the sign to the elevation of the near edge of the pavement, of signs installed at the side of the road in rural areas shall be 5 feet (see Figure 2A-2).**

05 **The minimum height, measured vertically from the bottom of the sign to the top of the curb, or in the absence of curb, measured vertically from the bottom of the sign to the elevation of the near edge of the traveled way, of signs installed at the side of the road in business, commercial, or residential areas where parking or pedestrian movements are likely to occur, or where the view of the sign might be obstructed shall be 7 feet (see Figure 2A-2).**

Option:

06 The height to the bottom of a secondary sign mounted below another sign may be 1 foot less than the height specified in Paragraphs 4 and 5.

Standard:

07 **The minimum height, measured vertically from the bottom of the sign to the sidewalk, of signs installed above sidewalks shall be 7 feet.**

08 **If the bottom of a secondary sign that is mounted below another sign is mounted lower than 7 feet above a pedestrian sidewalk or pathway (see Section 6D.02), the secondary sign shall not project more than 4 inches into the pedestrian facility.**

Option:

09 Signs that are placed 30 feet or more from the edge of the traveled way may be installed with a minimum height of 5 feet, measured vertically from the bottom of the sign to the elevation of the near edge of the pavement.

Standard:

10 **Directional signs on freeways and expressways shall be installed with a minimum height of 7 feet measured vertically from the bottom of the sign to the elevation of the near edge of the pavement. All route signs, warning signs, and regulatory signs on freeways and expressways shall be installed with a minimum height of 7 feet, measured vertically from the bottom of the sign to the elevation of the near edge of the pavement. If a secondary sign is mounted below another sign on a freeway or expressway, the major sign shall be installed with a minimum height of 8 feet and the secondary sign shall be installed with a minimum height of 5 feet, measured vertically from the bottom of the sign to the elevation of the near edge of the pavement.**

11 **Where large signs having an area exceeding 50 square feet are installed on multiple breakaway posts, the clearance from the ground to the bottom of the sign shall be at least 7 feet.**

Option:

12 A route sign assembly consisting of a route sign and auxiliary signs (see Section 2D.12) may be treated as a single sign for the purposes of this Section.

13 The mounting height may be adjusted when supports are located near the edge of the right-of-way on a steep backslope in order to avoid the sometimes less desirable alternative of placing the sign closer to the roadway.

Standard:

- 14 **Overhead signs shall provide a vertical clearance of not less than 17 feet to the sign, light fixture, or sign bridge over the entire width of the pavement and shoulders except where the structure on which the overhead signs are to be mounted or other structures along the roadway near the sign structure have a lesser vertical clearance.**

Option:

- 15 If the vertical clearance of other structures along the roadway near the sign structure is less than 16 feet, the vertical clearance to an overhead sign structure or support may be as low as 1 foot higher than the vertical clearance of the other structures in order to improve the visibility of the overhead signs.
- 16 In special cases it may be necessary to reduce the clearance to overhead signs because of substandard dimensions in tunnels and other major structures such as double-deck bridges.

Support:

- 17 Figure 2A-2 illustrates some examples of the mounting height requirements contained in this Section.

Section 2A.19 Lateral Offset**Standard:**

- 01 **For overhead sign supports, the minimum lateral offset from the edge of the shoulder (or if no shoulder exists, from the edge of the pavement) to the near edge of overhead sign supports (cantilever or sign bridges) shall be 6 feet. Overhead sign supports shall have a barrier or crash cushion to shield them if they are within the clear zone.**
- 02 **Post-mounted sign and object marker supports shall be crashworthy (breakaway, yielding, or shielded with a longitudinal barrier or crash cushion) if within the clear zone.**

Guidance:

- 03 *For post-mounted signs, the minimum lateral offset should be 12 feet from the edge of the traveled way. If a shoulder wider than 6 feet exists, the minimum lateral offset for post-mounted signs should be 6 feet from the edge of the shoulder.*

Support:

- 04 The minimum lateral offset requirements for object markers are provided in Section 2C.65.
- 05 The minimum lateral offset is intended to keep trucks and cars that use the shoulders from striking the signs or supports.

Guidance:

- 06 *All supports should be located as far as practical from the edge of the shoulder. Advantage should be taken to place signs behind existing roadside barriers, on over-crossing structures, or other locations that minimize the exposure of the traffic to sign supports.*

Option:

- 07 Where permitted, signs may be placed on existing supports used for other purposes, such as highway traffic signal supports, highway lighting supports, and utility poles.

Standard:

- 08 **If signs are placed on existing supports, they shall meet other placement criteria contained in this Manual.**

Option:

- 09 Lesser lateral offsets may be used on connecting roadways or ramps at interchanges, but not less than 6 feet from the edge of the traveled way.
- 10 On conventional roads in areas where it is impractical to locate a sign with the lateral offset prescribed by this Section, a lateral offset of at least 2 feet may be used.
- 11 A lateral offset of at least 1 foot from the face of the curb may be used in business, commercial or residential areas where sidewalk width is limited or where existing poles are close to the curb.

Guidance:

- 12 *Overhead sign supports and post-mounted sign and object marker supports should not intrude into the usable width of a sidewalk or other pedestrian facility.*

13 Figures 2A-2 and 2A-3 illustrate some examples of the lateral offset requirements contained in this Section.

Section 2A.20 Orientation

Guidance:

01 *Unless otherwise provided in this Manual, signs should be vertically mounted at right angles to the direction of, and facing, the traffic that they are intended to serve.*

02 *Where mirror reflection from the sign face is encountered to such a degree as to reduce legibility, the sign should be turned slightly away from the road. Signs that are placed 30 feet or more from the pavement edge should be turned toward the road. On curved alignments, the angle of placement should be determined by the direction of approaching traffic rather than by the roadway edge at the point where the sign is located.*

Option:

03 On grades, sign faces may be tilted forward or back from the vertical position to improve the viewing angle.

Section 2A.21 Posts and Mountings

Standard:

01 **Sign posts, foundations, and mountings shall be so constructed as to hold signs in a proper and permanent position, and to resist swaying in the wind or displacement by vandalism.**

Support:

02 The latest edition of AASHTO's "Specifications for Structural Supports for Highway Signs, Luminaires, and Traffic Signals" contains additional information regarding posts and mounting (see the Preface for AASHTO's address).

Option:

03 Where engineering judgment indicates a need to draw attention to the sign during nighttime conditions, a strip of retroreflective material may be used on regulatory and warning sign supports.

Standard:

04 **If a strip of retroreflective material is used on the sign support, it shall be at least 2 inches in width, it shall be placed for the full length of the support from the sign to within 2 feet above the edge of the roadway, and its color shall match the background color of the sign, except that the color of the strip for the YIELD and DO NOT ENTER signs shall be red.**

Section 2A.22 Maintenance

Guidance:

01 *Maintenance activities should consider proper position, cleanliness, legibility, and daytime and nighttime visibility (see Section 2A.08). Damaged or deteriorated signs, gates, or object markers should be replaced.*

02 *To assure adequate maintenance, a schedule for inspecting (both day and night), cleaning, and replacing signs, gates, and object markers should be established. Employees of highway, law enforcement, and other public agencies whose duties require that they travel on the roadways should be encouraged to report any damaged, deteriorated, or obscured signs, gates, or object markers at the first opportunity.*

03 *Steps should be taken to see that weeds, trees, shrubbery, and construction, maintenance, and utility materials and equipment do not obscure the face of any sign or object marker.*

04 *A regular schedule of replacement of lighting elements for illuminated signs should be maintained.*

Section 2A.23 Median Opening Treatments for Divided Highways with Wide Medians

Guidance:

01 *For traffic control purposes, where divided highways are separated by median widths at the median opening itself of 30 feet or more, median openings should be signed as two separate intersections.*

CHAPTER 2B. REGULATORY SIGNS, BARRICADES AND GATES

Section 2B.01 Application of Regulatory Signs

Standard:

- 01 **Regulatory signs shall be used to inform road users of selected traffic laws or regulations and indicate the applicability of the legal requirements.**
- 02 **Regulatory signs shall be installed at or near where the regulations apply. The signs shall clearly indicate the requirements imposed by the regulations and shall be designed and installed to provide adequate visibility and legibility in order to obtain compliance.**
- 03 **Regulatory signs shall be retroreflective or illuminated (see Section 2A.07) to show the same shape and similar color by both day and night, unless specifically stated otherwise in the text discussion in this Manual for a particular sign or group of signs.**
- 04 **Regulatory sign designs contained in the “Sign Designs and Markings Manual” (SDMM) (see Section 1A.11) are incorporated by reference into this Manual, and shall have the same legal applicability as if they had been included in this Manual.**
- 05 **The requirements for sign illumination shall not be considered to be satisfied by street or highway lighting.**

Support:

- 06 Section 1A.09 contains information regarding the assistance that is available to jurisdictions that do not have engineers on their staffs who are trained and/or experienced in traffic control devices.

Section 2B.02 Design of Regulatory Signs

Standard:

- 01 **Regulatory signs shall be rectangular unless specifically designated otherwise. Regulatory signs shall be designed in accordance with the sizes, shapes, colors, and legends contained in the “Sign Designs and Markings Manual” (SDMM).**

Option:

- 02 Regulatory word message signs other than those classified and specified in this Manual and the “Sign Designs and Markings Manual” (SDMM) (see Section 1A.11) may be developed to aid the enforcement of other laws or regulations.
- 03 Except for symbols on regulatory signs, minor modifications in the design may be permitted provided that the essential appearance characteristics are met.

Support:

- 04 The use of educational plaques to supplement symbol signs is described in Section 2A.12.

Guidance:

- 05 *Changeable message signs displaying a regulatory message incorporating a prohibitory message that includes a red circle and slash on a static sign should display a red symbol that approximates the same red circle and slash as closely as possible.*

Section 2B.03 Size of Regulatory Signs

Standard:

- 01 **Except as provided in Section 2A.11, the sizes for regulatory signs shall be as shown in Table 2B-1 and the “Sign Designs and Markings Manual” (SDMM) (see Section 1A.11).**

Support:

- 02 Section 2A.11 contains information regarding the applicability of the various columns in Table 2B-1.

Standard:

- 03 **Except as provided in Paragraphs 4 and 5, the minimum sizes for regulatory signs facing traffic on multi-lane conventional roads shall be as shown in the Multi-lane column of Table 2B-1.**

Table 2B-1. Regulatory Sign and Plaque Sizes¹ (Sheet 1 of 7)

Sign or Plaque	Sign Designation	Section	Conventional Road		Expressway	Freeway	Minimum ³	Oversized ⁴
			Single Lane	Multi-Lane ²				
STOP	R1-1	2B.05	30 x 30 ⁵	36 x 36	36 x 36	—	30 x 30	48 x 48
YIELD	R1-2	2B.08	36 x 36 x 36	48 x 48 x 48	48 x 48 x 48	60 x 60 x 60	30 x 30 x 30	—
TO ONCOMING TRAFFIC (plaque)	R1-2aP	2B.10	24 x 18		36 x 30	48 x 36	24 x 18	—
ALL WAY (plaque)	R1-3P	2B.05	18 x 6		—	—	—	30 x 12
Yield Here to Peds	R1-5	2B.11	—	36 x 36	—	—	—	36 x 36
Yield Here to Pedestrians	R1-5a	2B.11	—	36 x 36	—	—	—	36 x 48
In-Street Ped Crossing	R1-6	2B.12	12 x 36		—	—	—	—
Overhead Ped Crossing	R1-9	2B.12	90 x 24		—	—	—	—
SPEED LIMIT __	R2-1	2B.13	24 x 30	30 x 36	36 x 48	48 x 60	18 x 24	30 x 36
TRUCKS __ (plaque)	R2-2P	2B.14	24 x 24		36 x 36	48 x 48	—	36 x 36
VEHICLES OVER 4 TONS...	R2-H2a	2B.14	—		36 x 48	48 x 60	—	—
SPEED LIMIT 65 VEHICLES OVER..	R2-H2b	2B.13	—		36 x 72	48 x 96	—	—
Night Speed Limit (plaque)	R2-3P	2B.15	24 x 24		36 x 36	48 x 48	—	36 x 36
Minimum Speed Limit (plaque)	R2-4P	2B.16	24 x 30		36 x 48	48 x 60	—	36 x 48
Combined Speed Limit	R2-4a	2B.16	24 x 48		36 x 72	48 x 96	—	36 x 72
UNLESS OTHERWISE POSTED (plaque)	R2-5P	2B.13	24 x 18		—	—	—	—
CITYWIDE (plaque)	R2-5aP	2B.13	24 x 6		—	—	—	—
NEIGHBORHOOD (plaque)	R2-5bP	2B.13	24 x 6		—	—	—	—
RESIDENTIAL (plaque)	R2-5cP	2B.13	24 x 6		—	—	—	—
FINES HIGHER (plaque)	R2-6P	2B.17	24 x 18		36 x 24	48 x 36	—	36 x 24
FINES DOUBLE (plaque)	R2-6aP	2B.17	24 x 18		36 x 24	48 x 36	—	36 x 24
\$XX FINE (plaque)	R2-6bP	2B.17	24 x 18		36 x 24	48 x 36	—	36 x 24
BEGIN HIGHER FINES ZONE	R2-10	2B.17	24 x 30		36 x 48	48 x 60	—	36 x 48
END HIGHER FINES ZONE	R2-11	2B.17	24 x 30		36 x 48	48 x 60	—	36 x 48
Movement Prohibition	R3-1, 2, 3, 4, 18, 27	2B.18	24 x 24	36 x 36	36 x 36	—	—	48 x 48
Mandatory Movement Lane Control	R3-5,5a	2B.20	30 x 36		—	—	—	—
LEFT LANE (plaque)	R3-5bP	2B.20	30 x 12		—	—	—	—

Table 2B-1. Regulatory Sign and Plaque Sizes¹ (Sheet 2 of 7)

Sign or Plaque	Sign Designation	Section	Conventional Road		Expressway	Freeway	Minimum ³	Oversized ⁴
			Single Lane	Multi-Lane ²				
HOV 2+ (plaque)	R3-5cP	2B.20	24 x 12		—	—	—	—
TAXI LANE (plaque)	R3-5dP	2B.20	30 x 12		—	—	—	—
CENTER LANE (plaque)	R3-5eP	2B.20	30 x 12		—	—	—	—
RIGHT LANE (plaque)	R3-5fP	2B.20	30 x 12		—	—	—	—
BUS LANE (plaque)	R3-5gP	2B.20	30 x 12		—	—	—	—
Optional Movement Lane Control	R3-6	2B.21	30 x 36		—	—	—	—
RIGHT (LEFT) LANE MUST TURN RIGHT (LEFT)	R3-7	2B.20	30 x 30	36 x 36	—	—	—	—
Advance Intersection Lane Control	R3-8, 8a, 8b	2B.22	Varies x 30		Varies x30	Varies x30	—	Varies x36
Two-Way Left Turn Only (overhead)	R3-9a	2B.24	30 x 36		—	—	—	—
Two-Way Left Turn Only (post-mounted)	R3-9b	2B.24	24 x 36		—	—	—	36 x 48
BEGIN	R3-9cP	2B.25	30 x 12		—	—	—	—
END	R3-9dP	2B.25	30 x 12		—	—	—	—
Reversible Lane Control (Symbol)	R3-9e	2B.26	108 x 48		—	—	—	—
Reversible Lane Control (post-mounted)	R3-9f	2B.26	30 x 42	36 x 54	—	—	—	—
Advance Reversible Lane Control Transition Signing	R3-9g,9h	2B.26	108 x 36		—	—	—	—
END REVERSE LANE	R3-9i	2B.26	108 x 48		—	—	—	—
Begin Right (Left) Turn Lane	R3-20	2B.20	24 x 36		—	—	—	—
ALL TURNS (U TURN) FROM RIGHT LANE	R3-23, 23a	2B.27	60 x 36		—	—	—	—
ALL TURNS (U TURN) with arrow	R3-24, 24b, 25, 25b, 26a	2B.27	72 x 18		—	—	—	—
U AND LEFT TURNS with arrow	R3-24a, 25a, 26	2B.27	60 X 24		—	—	—	—
RIGHT LANE MUST EXIT	R3-33	2B.23	—		78 X 36	78 X 36	—	—
DO NOT PASS	R4-1	2B.28	24 x 30		36 x 48	48 x 60	18 x 24	36 x 48
PASS WITH CARE	R4-2	2B.29	24 x 30		36 x 48	48 x 60	18 x 24	36 x 48
SLOWER TRAFFIC KEEP RIGHT	R4-3	2B.30	24 x 30		36 x 48	48 x 60	18 x 24	36 x 48
THROUGH TRAFFIC KEEP RIGHT (LEFT)	R4-H3a	2B.32	24 x 30		36 x 48	48 x 60	18 x 24	36 x 48
TRUCKS USE RIGHT LANE	R4-5	2B.31	24 x 30		36 x 48	48 x 60	—	36 x 48
Keep Right	R4-7, 7a, 7b	2B.32	24 x 30		36 x 48	48 x 60	18 x 24	36 x 48
Narrow Keep Right	R4-7c	2B.32	18 x 30		—	—	—	—
Keep Left	R4-8, 8a, 8b	2B.32	24 x 30		36 x 48	48 x 60	18 x 24	36 x 48

Table 2B-1. Regulatory Sign and Plaque Sizes¹ (Sheet 3 of 7)

Sign or Plaque	Sign Designation	Section	Conventional Road		Expressway	Freeway	Minimum ³	Oversized ⁴
			Single Lane	Multi-Lane ²				
Narrow Keep Left	R4-8c	2B.32	18 x 30		—	—	—	—
STAY IN LANE	R4-9	2B.33	24 x 30		36 x 48	48 x 60	18 x 24	36 x 48
RUNAWAY VEHICLES ONLY	R4-10	2B.34	48 x 48		—	—	—	—
SLOW VEHICLES WITH XX OR MORE FOLLOWING VEHICLES MUST USE TURN-OUT	R4-12	2B.35	42 x 24		—	—	—	—
SLOW VEHICLES MUST USE TURN-OUT AHEAD	R4-13	2B.35	42 x 24		—	—	—	—
SLOW VEHICLES MUST TURN OUT	R4-14	2B.35	30 x 42		—	—	—	—
DO NOT DRIVE ON SHOULDER	R4-17	2B.36	24 x 30		36 x 48	48 x 60	18 x 24	36 x 48
DO NOT PASS ON SHOULDER	R4-18	2B.36	24 x 30		36 x 48	48 x 60	18 x 24	36 x 48
DO NOT ENTER	R5-1	2B.37	30 x 30	36 x 36	36 x 36	48 x 48	—	36 x 36
WRONG WAY	R5-1a	2B.38	36 x 24	42 x 30	36 x 24*	42 x 30	30 x 18*	42 x 30
No Trucks	R5-2, 2a	2B.39	24 x 24		30 x 30	36 x 36	—	36 x 36
NO THROUGH TRUCKS	R5-H2b	2B.39	24 x 24		30 x 30	36 x 36	—	36 x 36
NO THROUGH TRAFFIC	R5-H2c	2B.39	24 x 24		30 x 30	36 x 36	—	36 x 36
NO MOTOR VEHICLES	R5-3	2B.39	24 x 24		—	—	24 x 24	—
NO COMMERCIAL VEHICLES	R5-4	2B.39	24 x 30		36 x 48	36 x 48	—	—
NO VEHICLES WITH LUGS	R5-5	2B.39	24 x 30		36 x 48	48 x 60	—	—
No Bicycles	R5-6	2B.39	24 x 24		30 x 30	36 x 36	24 x 24	48 x 48
NO NON-MOTORIZED TRAFFIC	R5-7	2B.39	30 x 24		42 x 24	48 x 30	—	42 x 24
NO MOTOR-DRIVEN CYCLES	R5-8	2B.39	30 x 24		42 x 24	48 x 30	—	42 x 24
NO PEDESTRIANS, BICYCLES, MOTOR-DRIVEN CYCLES	R5-10a	2B.39	30 x 36		—	—	—	—
NO PEDESTRIANS OR BICYCLES	R5-10b	2B.39	30 x 18		—	—	—	—
NO PEDESTRIANS	R5-10c	2B.39	24 x 12		—	—	—	—
NO PEDESTRIANS FARM MACHINERY ANIMALS....	R5-H10d	2B.39	36 x 36		—	—	—	—
NO PEDESTRIANS BICYCLES MOTORCYCLES...	R5-H10e	2B.39	30 x 30		—	—	—	—
NO SNOWMOBILES ALL PURPOSE VEHICLES	R5-H10f	2B/39	30 x 24		—	—	—	36 x 30
AUTHORIZED VEHICLES ONLY	R5-11	2B.39	30 x 24		—	—	—	—

Table 2B-1. Regulatory Sign and Plaque Sizes¹ (Sheet 4 of 7)

Sign or Plaque	Sign Designation	Section	Conventional Road		Expressway	Freeway	Minimum ³	Oversized ⁴
			Single Lane	Multi-Lane ²				
ONE WAY (enclosed in arrow)	R6-1	2B.40	36 x 12	54 x 18	54 x 18	54 x 18	—	54 x 18
ONE WAY / (arrow)	R6-2	2B.40	24 x 30	30 x 36	36 x 48	48 x 60	18 x 24	36 x 48
Divided Highway Crossing	R6-3, 3a	2B.42	30 x 24		36 x 30	—	—	36 x 30
Roundabout Directional (2 chevrons)	R6-4	2B.43	30 x 24		—	—	—	—
Roundabout Directional (3 chevrons)	R6-4a	2B.43	48 x 24		—	—	—	—
Roundabout Directional (4 chevrons)	R6-4b	2B.43	60 x 24		—	—	—	—
Roundabout Circulation (plaque)	R6-5P	2B.44	30 x 30		—	—	—	—
BEGIN ONE WAY	R6-6	2B.40	24 x 30	30 x 36	—	—	—	—
END ONE WAY	R6-7	2B.40	24 x 30	30 x 36	—	—	—	—
Parking Restrictions	R7-1, 2, 2a, 3, 4, 5, 6, 7, 8, 21, 21a, 22, 23, 23a, 107, 108	2B.46	12 x 18		—	—	—	—
\$250 FINE MINIMUM (plaque)	R7-H8bP	2B.46	12 x 6		—	—	—	—
VAN ACCESSIBLE (plaque)	R7-8P	2B.46	12 x 6		—	—	—	—
Fee Station (symbol)	R7-20	2B.46	24 x 18		—	—	—	—
NO PARKING (with transit logo)	R7-107a	2B.46	12 x 30		—	—	—	—
No Parking/ Restricted Parking (combined sign)	R7-200	2B.46	24 x 18		—	—	—	—
No Parking/ Restricted Parking (combined sign)	R7-200a	2B.46	12 x 30		—	—	—	—
TOW AWAY ZONE (plaque)	R7-201P, 201aP	2B.46	12 x 6		—	—	—	—
THIS SIDE OF SIGN (plaque)	R7-202P	2B.46	12 x 6		—	—	—	—
Emergency Snow Route	R7-203	2B.46	18 x 24		—	—	—	24 x 30
NO PARKING ON PAVEMENT	R8-1	2B.46	24 x 30		36 x 48	48 x 60	—	36 x 48
NO PARKING EXCEPT ON SHOULDER	R8-2	2B.46	24 x 30		36 x 48	48 x 60	—	36 x 48
No Parking (symbol)	R8-3	2B.46	24 x 24	30 x 30	36 x 36	48 x 48	12 x 12	36 x 36
NO PARKING	R8-3a	2B.46	24 x 30		36 x 36	48 x 48	18 x 24	36 x 36
EXCEPT SUNDAYS AND HOLIDAYS	R8-3bP	2B.46	24 x 18		—	—	12 x 9	30 x 24

Table 2B-1. Regulatory Sign and Plaque Sizes¹ (Sheet 5 of 7)

Sign or Plaque	Sign Designation	Section	Conventional Road		Expressway	Freeway	Minimum ³	Oversized ⁴
			Single Lane	Multi-Lane ²				
ON PAVEMENT (plaque)	R8-3cP	2B.46	24 x 18		—	—	12 x 9	30 x 24
ON BRIDGE (plaque)	R8-3dP	2B.46	24 x 18		—	—	12 x 9	30 x 24
ON TRACKS (plaque)	R8-3eP	2B.46	12 x 9		—	—	—	30 x 24
EXCEPT ON SHOULDER (plaque)	R8-3fP	2B.46	24 x 18		—	—	12 x 9	30 x 24
LOADING ZONE (plaque)	R8-3gP	2B.46	24 x 18		—	—	12 x 9	30 x 24
TIMES OF DAY (plaque)	R8-3hP	2B.46	24 x 18		—	—	12 x 9	30 x 24
EMERGENCY PARKING ONLY	R8-4	2B.49	30 x 24		30 x 24	48 x 36	—	48 x 36
NO STOPPING ON PAVEMENT	R8-5	2B.46	24 x 30		36 x 48	48 x 60	—	36 x 48
NO STOPPING EXCEPT ON SHOULDER	R8-6	2B.46	24 x 30		36 x 48	48 x 60	—	36 x 48
EMERGENCY STOPPING ONLY	R8-7	2B.49	30 x 24		48 x 36	48 x 36	—	48 x 36
WALK ON LEFT FACING TRAFFIC	R9-1	2B.50	18 x 24		—	—	—	—
CROSS ONLY AT CROSSWALKS	R9-2	2B.51	12 x 18		—	—	—	—
No Pedestrian Crossing (symbol)	R9-3	2B.51	18 x 18		24 x 24	30 x 30	—	30 x 30
NO PEDESTRIAN CROSSING	R9-3a	2B.51	12 x 18		—	—	—	—
USE CROSSWALK (plaque)	R9-3bP	2B.51	18 x 12		—	—	—	—
No Hitchhiking (symbol)	R9-4	2B.50	18 x 18		—	—	—	24 x 24
NO HITCHHIKING	R9-4a	2B.50	18 x 24		—	—	12 x 18	—
No Skaters	R9-13	2B.39	18 x 18		24 x 24	30 x 30	—	30 x 30
No Equestrians	R9-14	2B.39	18 x 18		24 x 24	30 x 30	—	30 x 30
CROSS ONLY ON GREEN (ball symbol)	R10-1	2B.52	12 x 18		—	—	—	—
Pedestrian Signs and Plaques	R10-2, 3, 3b, 3c, 3d, 4	2B.52	9 x 12		—	—	—	—
Pedestrian Signs	R10-3a, 3e, 3f, 3g, 3h, 3i, 4a	2B.52	9 x 15		—	—	—	—
LEFT ON GREEN ARROW ONLY	R10-5	2B.53	30 x 36		48 x 60	—	24 x 30	48 x 60
STOP HERE ON RED (arrow)	R10-6	2B.53	24 x 36		—	—	—	36 x 48
STOP HERE ON RED (curved arrow)	R10-6a	2B.53	24 x 30		—	—	—	36 x 42
DO NOT BLOCK INTERSECTION	R10-7	2B.53	24 x 30		—	—	—	—
USE LANE WITH GREEN ARROW	R10-8	2B.53	36 x 42		36 x 42	—	—	60 x 72
LEFT (RIGHT) TURN SIGNAL	R10-10	2B.53	30 x 36		—	—	—	—

Table 2B-1. Regulatory Sign and Plaque Sizes¹ (Sheet 6 of 7)

Sign or Plaque	Sign Designation	Section	Conventional Road		Express-way	Freeway	Minimum ³	Oversized ⁴
			Single Lane	Multi-Lane ²				
NO TURN ON RED (red symbol)	R10-11	2B.54	24 x 30	36 x 48	—	—	—	36 x 48
NO TURN ON RED	R10-11a	2B.54	30 x 36	36 x 48	—	—	—	—
NO TURN ON RED (square)	R10-11b	2B.54	36 x 36		—	—	—	—
NO TURN ON RED EXCEPT FROM RIGHT LANE	R10-11c	2B.54	30 x 42		—	—	—	—
NO TURN ON RED FROM THIS LANE	R10-11d	2B.54	30 x 42		—	—	—	—
LEFT TURN YIELD ON GREEN (green symbol)	R10-12	2B.53	30 x 36		—	—	—	—
LEFT TURN YIELD ON FLASHING YELLOW ARROW	R10-H12c	2B.53	30 x 36		—	—	—	—
EMERGENCY SIGNAL	R10-13	2B.53	42 x 30		—	—	—	—
EMERGENCY SIGNAL – STOP ON FLASHING RED	R10-14	2B.53	36 x 42		—	—	—	—
EMERGENCY SIGNAL – STOP ON FLASHING RED (overhead)	R10-14a	2B.53	60 x 24		—	—	—	—
STOP HERE ON FLASHING RED	R10-14b	2B.53	24 x 36		—	—	—	36 x 48
Turning Vehicles Yield To Peds (symbol)	R10-15	2B.53	30 x 30		—	—	—	—
U-TURN YIELD TO RIGHT TURN	R10-16	2B.53	30 x 36		—	—	—	—
RIGHT ON RED ARROW AFTER STOP	R10-17a	2B.54	36 x 48		—	—	—	—
TRAFFIC LAWS PHOTO ENFORCED	R10-18	2B.55	36 x 24		48 x 30	54 x 36	—	54 x 36
Photo Enforced (symbol plaque)	R10-19P	2B.55	24 x 12		36 x 18	48 x 24	—	48 x 24
PHOTO ENFORCED (plaque)	R10-19aP	2B.55	24 x 18		36 x 30	48 x 36	—	48 x 36
MON-FRI (and times) (3 lines) (plaque)	R10-20aP	2B.53	24 x 24		—	—	—	—
SUNDAY (and times) (2 lines) (plaque)	R10-20aP	2B.53	24 x 18		—	—	—	—
CROSSWALK / STOP ON RED (symbol)	R10-23	2B.53	24 x 30		—	—	—	—
PUSH BUTTON TO TURN ON WARNING LIGHTS	R10-25	2B.52	9 x 12		—	—	—	—
LEFT TURN YIELD ON FLASHING RED ARROW AFTER STOP	R10-27	2B.53	30 x 36		30 x 36	—	—	—
XX VEHICLES PER GREEN	R10-28	2B.56	24 x 30		—	—	—	—
XX VEHICLES PER GREEN EACH LANE	R10-29	2B.56	36 x 24		—	—	—	—
RIGHT TURN ON RED MUST YIELD TO U-TURN	R10-30	2B.54	30 x 36		—	—	—	—
AT SIGNAL (plaque)	R10-31P	2B.53	24 x 9		—	—	—	—

Table 2B-1. Regulatory Sign and Plaque Sizes¹ (Sheet 7 of 7)

Sign or Plaque	Sign Designation	Section	Conventional Road		Express -way	Freeway	Minimum ³	Oversized ⁴
			Single Lane	Multi-Lane ²				
PUSH BUTTON FOR 2 SECONDS FOR EXTRA CROSSING TIME	R10-32P	2B.52	9 x 12		—	—	—	—
KEEP OFF MEDIAN	R11-1	2B.57	24 x 30		—	—	—	—
ROAD CLOSED	R11-2	2B.58	48 x 30		—	—	—	—
ROAD CLOSED – LOCAL TRAFFIC ONLY	R11-3a, 3b, 4	2B.58	60 x 30		—	—	—	—
Weight Limit	R12-1, 2	2B.59	24 x 30		36 x 48	—	—	36 x 48
Weight Limit	R12-3	2B.59	24 x 36		—	—	—	—
Weight Limit	R12-4	2B.59	36 x 24		—	—	—	—
Weight Limit	R12-H5	2B.59	30 x 42		36 x 54	48 x 72	—	—
Weigh Station	R13-H1	2B.60	72 x 60		120 x 96	120 x 96	—	—
Weigh Station	R13-H2	2B.60	72 x 48		120 x 72	120 x 72	—	—
TRUCK ROUTE	R14-1	2B.61	24 x 18		—	—	—	—
Hazardous Material	R14-2, 3	2B.62	24 x 24		30 x 30	36 x 36	—	42 x 42
(Seat belt symbol) STATE LAW	R16-H1	2B.66	24 x 30		36 x 48	48 x 60	—	—
FENDER BENDER MOVE VEHICLES...	R16-4	2B.65	36 x 24		48 x 36	60 x 48	—	48 x 36
LIGHTS ON WHEN USING WIPERS OR RAINING	R16-5, 6	2B.64	24 x 30		36 x 48	48 x 60	—	36 x 48
TURN ON HEADLIGHTS NEXT XX MILES	R16-7	2B.64	48 x 15		72 x 24	96 x 30	—	72 x 24
TURN ON (CHECK) HEADLIGHTS	R16-8, 9	2B.64	30 x 15		48 x 24	60 x 30	—	48 x 24
BEGIN, (END) DAYTIME HEADLIGHT SECTION	R16-10, 11	2B.64	48 x 15		72 x 24	96 x 30	—	72 x 24

Notes:

1. a.) Larger signs may be used when appropriate;
b.) Dimensions in inches are shown as width x height;
c.) See Table 9B-1 for minimum sizes required for signs on bicycle facilities.
2. For additional information regarding regulatory sign sizes on multi-lane conventional roads refer to Section 2B.03, Paragraphs 3, 4, and 5.
3. Refer to Section 2A.11, Paragraph 2 regarding the use of Minimum sign sizes.
4. Refer to Section 2A.11, Paragraph 5 regarding the use of Oversized signs.
5. Where a single lane conventional road intersects a multi-lane street or highway that has a speed limit of 45 mph or higher, the minimum size of the STOP sign facing the single lane conventional road shall be 36 x 36 inches (see Section 2B.03, Paragraph 7).

Option:

04 Where the posted speed limit is 35 mph or less on a multi-lane highway or street, other than for a STOP sign, the minimum size shown in the Single Lane column in Table 2B-1 may be used.

05 Where a regulatory sign, other than a STOP sign, is placed on the left-hand side of a multi-lane roadway in addition to the installation of the same regulatory sign on the right-hand side of the roadway, the size shown in the Single Lane column in Table 2B-1 may be used for both the sign on the right-hand side and the sign on the left-hand side of the roadway.

Standard:

- 06 **A minimum size of 36 x 36 inches shall be used for STOP signs that face multi-lane approaches.**
- 07 **Where side roads intersect a multi-lane street or highway that has a speed limit of 45 mph or higher, the minimum size of the STOP signs facing the side road approaches, even if the side road only has one approach lane, shall be 36 x 36 inches.**
- 08 **Where side roads intersect a multi-lane street or highway that has a speed limit of 40 mph or lower, the minimum size of the STOP signs facing the side road approaches shall be as shown in the Single Lane or Multi-lane columns of Table 2B-1 based on the number of approach lanes on the side street approach.**

Guidance:

- 09 *The minimum sizes for regulatory signs facing traffic on exit and entrance ramps should be as shown in the column of Table 2B-1 that corresponds to the mainline roadway classification (Expressway or Freeway). If a minimum size is not provided in the Freeway column, the minimum size in the Expressway column should be used. If a minimum size is not provided in the Freeway or Expressway Column, the size in the Oversized column should be used.*

Section 2B.04 Right-of-Way at Intersections*Support:*

- 01 ORC Section 4511.41 (see Appendix B2) establishes the right-of-way rule at intersections having no regulatory traffic control signs such that the driver of a vehicle approaching an intersection must yield the right-of-way to any vehicle or pedestrian already in the intersection. When two vehicles approach an intersection from different streets or highways at approximately the same time, the right-of-way rule requires the driver of the vehicle on the left to yield the right-of-way to the vehicle on the right. The right-of-way can be modified at through streets or highways by placing YIELD (R1-2) signs (see Sections 2B.08 and 2B.09) or STOP (R1-1) signs (see Sections 2B.05 through 2B.07) on one or more approaches. ORC Sections 4511.42 and 4511.43 establish right-of-way when turning left and at intersections with STOP and YIELD signs (see Appendix B2).

Guidance:

- 02 *Engineering judgment should be used to establish intersection control. The following factors should be considered:*
- A. *Vehicular, bicycle, and pedestrian traffic volumes on all approaches;*
 - B. *Number and angle of approaches;*
 - C. *Approach speeds;*
 - D. *Sight distance available on each approach; and*
 - E. *Reported crash experience.*
- 03 *YIELD or STOP signs should be used at an intersection if one or more of the following conditions exist:*
- A. *An intersection of a less important road with a main road where application of the normal right-of-way rule would not be expected to provide reasonable compliance with the law;*
 - B. *A street entering a designated through highway or street; and/or*
 - C. *An unsignalized intersection in a signalized area.*
- 04 *In addition, the use of YIELD or STOP signs should be considered at the intersection of two minor streets or local roads where the intersection has more than three approaches and where one or more of the following conditions exist:*
- A. *The combined vehicular, bicycle, and pedestrian volume entering the intersection from all approaches averages more than 2,000 units per day;*
 - B. *The ability to see conflicting traffic on an approach is not sufficient to allow a road user to stop or yield in compliance with the normal right-of-way rule if such stopping or yielding is necessary; and/or*
 - C. *Crash records indicate that five or more crashes that involve the failure to yield the right-of-way at the intersection under the normal right-of-way rule have been reported within a 3-year period, or that three or more such crashes have been reported within a 2-year period.*
- 05 *YIELD or STOP signs should not be used for speed control.*

Support:

06 Section 2B.07 contains provisions regarding the application of multi-way STOP control at an intersection.

Guidance:

07 *Once the decision has been made to control an intersection, the decision regarding the appropriate roadway to control should be based on engineering judgment. In most cases, the roadway carrying the lowest volume of traffic should be controlled.*

08 *A YIELD or STOP sign should not be installed on the higher volume roadway unless justified by an engineering study.*

Support:

09 The following are considerations that might influence the decision regarding the appropriate roadway upon which to install a YIELD or STOP sign where two roadways with relatively equal volumes and/or characteristics intersect:

- A. Controlling the direction that conflicts the most with established pedestrian crossing activity or school walking routes;
- B. Controlling the direction that has obscured vision, dips, or bumps that already require drivers to use lower operating speeds; and
- C. Controlling the direction that has the best sight distance from a controlled position to observe conflicting traffic.

Standard:

10 **Because the potential for conflicting commands could create driver confusion, YIELD or STOP signs shall not be used in conjunction with any traffic control signal operation, except in the following cases:**

- A. If the signal indication for an approach is a flashing red at all times;**
- B. If a minor street or driveway is located within or adjacent to the area controlled by the traffic control signal, but does not require separate traffic signal control because an extremely low potential for conflict exists; or**
- C. If a channelized turn lane is separated from the adjacent travel lanes by an island and the channelized turn lane is not controlled by a traffic control signal.**

11 **Except as provided in Section 2B.09, STOP signs and YIELD signs shall not be installed on different approaches to the same unsignalized intersection if those approaches conflict with or oppose each other.**

12 **Portable or part-time STOP or YIELD signs shall not be used except for emergency and temporary traffic control zone purposes.**

13 **A portable or part-time (folding) STOP sign that is manually placed into view and manually removed from view shall not be used during a power outage to control a signalized approach unless the maintaining agency establishes that the signal indication that will first be displayed to that approach upon restoration of power is a flashing red signal indication and that the portable STOP sign will be manually removed from view prior to stop-and-go operation of the traffic control signal.**

Option:

14 A portable or part-time (folding) STOP sign that is electrically or mechanically operated such that it only displays the STOP message during a power outage and ceases to display the STOP message upon restoration of power may be used during a power outage to control a signalized approach.

Support:

15 Section 9B.03 contains provisions regarding the assignment of priority at a shared-use path/roadway intersection.

Figure 2B-1. STOP and YIELD Signs and Plaques



Section 2B.05 STOP Sign (R1-1) and ALL WAY Plaque (R1-3P)

Standard:

01 When it is determined that a full stop is always required on an approach to an intersection, a
 02 STOP (R1-1) sign (see Figure 2B-1) shall be used. See Section 2B.03 for size requirements for STOP
 03 signs.

04 The STOP sign shall be an octagon with a white legend and border on a red background.

05 Secondary legends shall not be used on STOP sign faces.

06 At intersections where all approaches are controlled by STOP signs (see Section 2B.07), an ALL
 07 WAY supplemental plaque (R1-3P) shall be mounted below each STOP sign. The ALL WAY plaque
 08 (see Figure 2B-1) shall have a white legend and border on a red background.

09 The ALL WAY plaque shall only be used if all intersection approaches are controlled by STOP
 10 signs.

11 Supplemental plaques with legends such as 2-WAY, 3-WAY, 4-WAY, or other numbers of ways
 12 shall not be used with STOP signs.

Support:

13 The use of the CROSS TRAFFIC DOES NOT STOP (W4-4P) plaque (and other plaques with variations
 14 of this word message) is described in Section 2C.59.

Guidance:

15 *Plaques with the appropriate alternative messages of TRAFFIC FROM LEFT (RIGHT) DOES NOT*
 16 *STOP (W4-4aP) or ONCOMING TRAFFIC DOES NOT STOP (W4-4bP) should be used at intersections*
 17 *where STOP signs control all but one approach to the intersection, unless the only non-stopped approach is*
 18 *from a one-way street.*

Support:

19 The design and application of Stop Beacons are described in Section 4L.05.

Section 2B.06 STOP Sign Applications

Guidance:

20 *At intersections where a full stop is not necessary at all times, consideration should first be given to*
 21 *using less restrictive measures such as YIELD signs (see Section 2B.08 and 2B.09).*

22 *The use of STOP signs on the minor-street approaches should be considered if engineering judgment*
 23 *indicates that a stop is always required because of one or more of the following conditions:*

- A. *The vehicular traffic volumes on the through street or highway exceed 6,000 vehicles per day;*
- B. *A restricted view exists that requires road users to stop in order to adequately observe conflicting traffic on the through street or highway; and/or*
- C. *Crash records indicate that three or more crashes that are susceptible to correction by the installation of a STOP sign have been reported within a 12-month period, or that five or more such crashes have been reported within a 2-year period. Such crashes include right-angle collisions involving road users on the minor-street approach failing to yield the right-of-way to traffic on the through street or highway.*

03 The use of STOP signs at grade crossings is described in Section 8B.04 and 8B.05.

Section 2B.07 Multi-Way Stop Applications

Support:

01 Multi-way stop control can be useful as a safety measure at intersections if certain traffic conditions exist. Safety concerns associated with multi-way stops include pedestrians, bicyclists, and all road users expecting other road users to stop. Multi-way stop control is used where the volume of traffic on the intersecting roads is approximately equal.

02 The restrictions on the use of STOP signs described in Section 2B.04 also apply to multi-way stop applications.

Guidance:

03 *The decision to install multi-way stop control should be based on an engineering study.*

04 *The following criteria should be considered in the engineering study for a multi-way STOP sign installation:*

- A. *Where traffic control signals are justified, the multi-way stop is an interim measure that can be installed quickly to control traffic while arrangements are being made for the installation of the traffic control signal.*
- B. *Five or more reported crashes in a 12-month period that are susceptible to correction by a multi-way stop installation. Such crashes include right-turn and left-turn collisions as well as right-angle collisions.*
- C. *Minimum volumes:*
 - 1. *The vehicular volume entering the intersection from the major street approaches (total of both approaches) averages at least 300 vehicles per hour for any 8 hours of an average day, and*
 - 2. *The combined vehicular, pedestrian, and bicycle volume entering the intersection from the minor street approaches (total of both approaches) averages at least 200 units per hour for the same 8 hours, with an average delay to minor-street vehicular traffic of at least 30 seconds per vehicle during the highest hour, but*
 - 3. *If the 85th-percentile approach speed of the major-street traffic exceeds 40 mph, the minimum volume warrants are 70 percent of the values provided in Items 1 and 2.*
- D. *Where no single criterion is satisfied, but where Criteria B, C.1, and C.2 are all satisfied to 80 percent of the minimum values. Criterion C.3 is excluded from this condition.*

Option:

05 Other criteria that may be considered in an engineering study include:

- A. The need to control left-turn conflicts;
- B. The need to control vehicle/pedestrian conflicts near locations that generate high pedestrian volumes;
- C. Locations where a road user, after stopping, cannot see conflicting traffic and is not able to negotiate the intersection unless conflicting cross traffic is also required to stop; and
- D. An intersection of two residential neighborhood collector (through) streets of similar design and operating characteristics where multi-way stop control would improve traffic operational characteristics of the intersection.

Section 2B.08 YIELD Sign (R1-2)

Standard:

01 **The YIELD (R1-2) sign (see Figure 2B-1) shall be a downward-pointing equilateral triangle with a wide red border and the legend YIELD in red on a white background.**

Support:

02 The YIELD sign assigns right-of-way to traffic on certain approaches to an intersection. Vehicles controlled by a YIELD sign need to slow down to a speed that is reasonable for the existing conditions or stop when necessary to avoid interfering with conflicting traffic.

Section 2B.09 YIELD Sign Applications**Option:**

- 01 YIELD signs may be installed:
- A. On the approaches to a through street or highway where conditions are such that a full stop is not always required.
 - B. At the second crossroad of a divided highway, where the median width at the intersection is 30 feet or greater. In this case, a STOP or YIELD sign may be installed at the entrance to the first roadway of a divided highway, and a YIELD sign may be installed at the entrance to the second roadway.
 - C. For a channelized turn lane that is separated from the adjacent travel lanes by an island, even if the adjacent lanes at the intersection are controlled by a highway traffic control signal or by a STOP sign.
 - D. At an intersection where a special problem exists and where engineering judgment indicates the problem to be susceptible to correction by the use of the YIELD sign.
 - E. Facing the entering roadway for a merge-type movement if engineering judgment indicates that control is needed because acceleration geometry and/or sight distance is not adequate for merging traffic operation.

Standard:

- 02 **A YIELD (R1-2) sign shall be used to assign right-of-way at the entrance to a roundabout. YIELD signs at roundabouts shall be used to control the approach roadways and shall not be used to control the circulatory roadway.**
- 03 **Other than for all of the approaches to a roundabout, YIELD signs shall not be placed on all of the approaches to an intersection.**

Section 2B.10 STOP Sign or YIELD Sign Placement**Standard:**

- 01 **The STOP or YIELD sign shall be installed on the near side of the intersection on the right-hand side of the approach to which it applies. When the STOP or YIELD sign is installed at this required location and the sign visibility is restricted, a Stop Ahead sign (see Section 2C.36 shall be installed in advance of the STOP sign or a Yield Ahead sign (see Section 2C.36) shall be installed in advance of the YIELD sign.**
- 02 **The STOP or YIELD sign shall be located as close as practical to the intersection it regulates, while optimizing its visibility to the road user it is intended to regulate.**
- 03 **YIELD signs and STOP signs shall not be mounted on the same post.**
- 04 **No items other than inventory stickers, sign installation dates, and bar codes shall be affixed to the fronts of STOP or YIELD signs, and the placement of these items shall be in the border of the sign.**
- 05 **No items other than official traffic control signs, inventory stickers, sign installation dates, anti-vandalism stickers, and bar codes shall be mounted on the backs of STOP or YIELD signs.**
- 06 **No items other than retroreflective strips (see Section 2A.21) or official traffic control signs shall be mounted on the fronts or backs of STOP or YIELD signs supports.**

Guidance:

- 07 *STOP or YIELD signs should not be placed farther than 50 feet from the edge of the pavement of the intersected roadway (see Drawing F in Figure 2A-3).*
- 08 *A sign that is mounted back-to-back with a STOP or YIELD sign should stay within the edges of the STOP or YIELD sign. If necessary, the size of the STOP or YIELD sign should be increased so that any other sign installed back-to-back with a STOP or YIELD sign remains within the edges of the STOP or YIELD sign.*

Option:

- 09 Where drivers proceeding straight ahead must yield to traffic approaching from the opposite direction, such as at a one-lane bridge, a TO ONCOMING TRAFFIC (R1-2aP) plaque may be mounted below the YIELD sign.

10 Figure 2A-3 shows examples of some typical placements of STOP signs and YIELD signs.

11 Section 2A.16 contains additional information about separate and combined mounting of other signs with STOP or YIELD signs.

Guidance:

12 *Stop lines that are used to supplement a STOP sign should be located as described in Section 3B.16. Yield lines that are used to supplement a YIELD sign should be located as described in Section 3B.16.*

13 *Where there is a marked crosswalk at the intersection, the STOP sign should be installed in advance of the crosswalk line nearest to the approaching traffic.*

14 *Except at roundabouts, where there is a marked crosswalk at the intersection, the YIELD sign should be installed in advance of the crosswalk line nearest to the approaching traffic.*

15 *Where two roads intersect at an acute angle, the STOP or YIELD sign should be positioned at an angle, or shielded, so that the legend is out of view of traffic to which it does not apply.*

16 *If a raised splitter island is available on the left-hand side of a multi-lane roundabout approach, an additional YIELD sign should be placed on the left-hand side of the approach.*

Option:

17 If a raised splitter island is available on the left-hand side of a single lane roundabout approach, an additional YIELD sign may be placed on the left-hand side of the approach.

18 At wide-throat intersections or where two or more approach lanes of traffic exist on the signed approach, observance of the right-of-way control may be improved by the installation of an additional STOP or YIELD sign on the left-hand side of the road and/or the use of a stop or yield line. At channelized intersections or at divided roadways separated by a median, the additional STOP or YIELD sign may be placed on a channelizing island or in the median. An additional STOP or YIELD sign may also be placed overhead facing the approach at the intersection to improve observance of the right-of-way control.

Standard:

19 **More than one STOP sign or more than one YIELD sign shall not be placed on the same support facing in the same direction.**

Option:

20 For a yield-controlled channelized right-turn movement onto a roadway without an acceleration lane and for an entrance ramp onto a freeway or expressway without an acceleration lane, a NO MERGE AREA (W4-5P) supplemental plaque (see Section 2C.40) may be mounted below a Yield Ahead (W3-2) sign and/or below a YIELD (R1-2) sign when engineering judgment indicates that road users would expect an acceleration lane to be present.

Section 2B.11 Yield Here To Pedestrians Signs (R1-5 Series)

Standard:

01 **Yield Here To Pedestrians (R1-5 or R1-5a) signs (see Figure 2B-2) shall be used if yield lines are used in advance of a marked crosswalk that crosses an uncontrolled multi-lane approach. The legend STATE LAW may be displayed at the top of the R1-5, or R1-5a.**

Guidance:

02 *If yield lines and Yield Here To Pedestrians signs are used in advance of a crosswalk that crosses an uncontrolled multi-lane approach, they should be placed 20 to 50 feet in advance of the nearest crosswalk line (see Section 3B.16 and Figure 3B-17), and parking should be prohibited in the area between the yield line and the crosswalk.*

03 *Yield lines and Yield Here To Pedestrians signs should not be used in advance of crosswalks that cross an approach to or departure from a roundabout.*

Option:

04 Yield Here To Pedestrians signs may be used in advance of a crosswalk that crosses an uncontrolled multi-lane approach to indicate to road users where to yield even if yield lines are not used.

Figure 2B-2. Unsignalized Pedestrian Crosswalk Signs

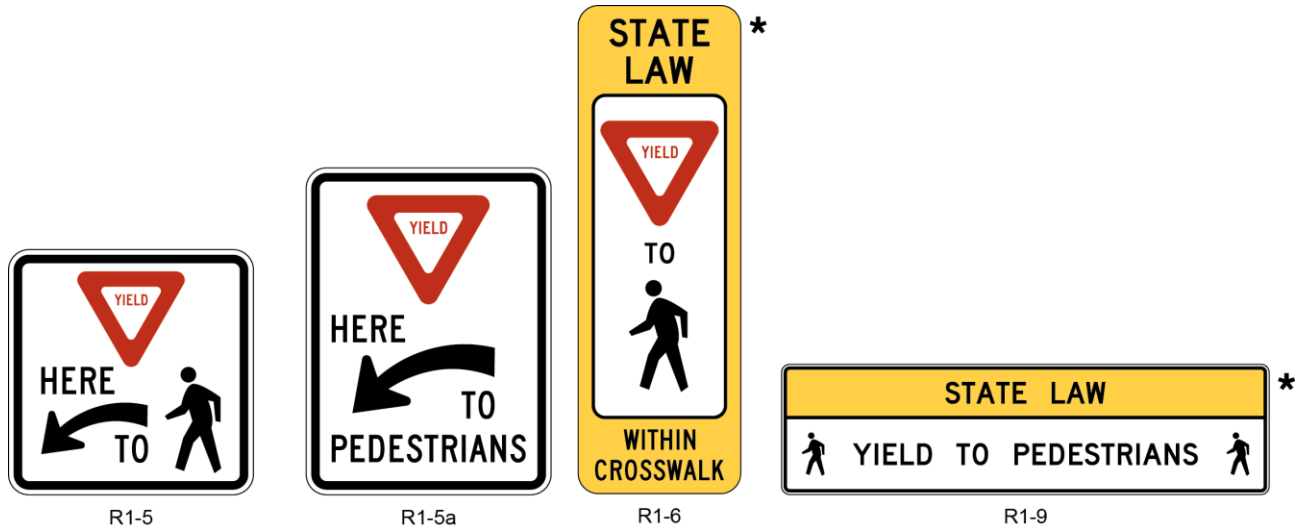

* The Legend STATE LAW is optional. A fluorescent yellow-green background color may be used instead of yellow for this sign.

05 A Pedestrian Crossing (W11-2) warning sign may be placed overhead or may be post-mounted with a diagonal downward pointing arrow (W16-7P) plaque at the crosswalk location where Yield Here To Pedestrians signs have been installed in advance of the crosswalk.

Standard:

06 **If a W11-2 sign has been post-mounted at the crosswalk location where a Yield Here To Pedestrians sign is used on the approach, the Yield Here To Pedestrians sign shall not be placed on the same post as or block the road user’s view of the W11-2 sign.**

Option:

07 An advance Pedestrian Crossing (W11-2) warning sign with an AHEAD or a distance supplemental plaque may be used in conjunction with a Yield Here To Pedestrians sign on the approach to the same crosswalk.

08 In-Street Pedestrian Crossing signs and Yield Here To Pedestrians signs may be used together at the same crosswalk.

Section 2B.12 In-Street and Overhead Pedestrian Crossing Signs (R1-6, R1-9)

Option:

01 The In-Street Pedestrian Crossing (R1-6) sign (see Figure 2B-2) or the Overhead Pedestrian Crossing (R1-9) sign (see Figure 2B-2) may be used to remind road users of laws regarding right-of-way at an unsignalized pedestrian crosswalk. The legend STATE LAW may be displayed at the top of the R1-6 and R1-9 signs. On the R1-6 sign, the legend YIELD may be used in conjunction with the appropriate YIELD sign symbol.

02 Highway agencies may develop and apply criteria for determining the applicability of In-Street Pedestrian Crossing signs.

Standard:

03 **If used, the In-Street Pedestrian Crossing sign shall be placed in the roadway at the crosswalk location on the center line, on a lane line, or on a median island. The In-Street Pedestrian Crossing sign shall not be post-mounted on the left-hand or right-hand side of the roadway.**

04 **If used, the Overhead Pedestrian Crossing sign shall be placed over the roadway at the crosswalk location.**

An In-Street or Overhead Pedestrian Crossing sign shall not be placed in advance of the crosswalk to educate road users about the State law prior to reaching the crosswalk, nor shall it be installed as an educational display that is not near any crosswalk.

Guidance:

If an island (see Chapter 3I) is available, the In-Street Pedestrian Crossing sign, if used, should be placed on the island.

Option:

If a Pedestrian Crossing (W11-2) warning sign is used in combination with an In-Street or an Overhead Pedestrian Crossing sign, the W11-2 sign with a diagonal downward pointing arrow (W16-7P) plaque may be post-mounted on the right-hand side of the roadway at the crosswalk location.

Standard:

The In-Street Pedestrian Crossing sign and the Overhead Pedestrian Crossing sign shall not be used at signalized locations.

The In-Street Pedestrian Crossing sign shall have a black legend (except for the red YIELD sign symbol) and border on a white background, surrounded by an outer yellow or fluorescent yellow-green background area (see Figure 2B-2). The Overhead Pedestrian Crossing sign shall have a black legend and border on a yellow or fluorescent yellow-green background at the top of the sign and a black legend and border on a white background at the bottom of the sign (see Figure 2B-2).

Unless the In-Street Pedestrian Crossing sign is placed on a physical island, the sign support shall be designed to bend over and then bounce back to its normal vertical position when struck by a vehicle.

Support:

Provisions of Section 2A.18 concerning mounting height are not applicable for the In-Street Pedestrian Crossing sign.

Standard:

The top of an In-Street Pedestrian Crossing sign shall be a maximum of 4 feet above the pavement surface. The top of an In-Street Pedestrian Crossing sign placed in an island shall be a maximum of 4 feet above the island surface.

Option:

The In-Street Pedestrian Crossing sign may be used seasonally to prevent damage in winter because of plowing operations, and may be removed at night if the pedestrian activity at night is minimal.

In-Street Pedestrian Crossing signs, Overhead Pedestrian Crossing signs, and Yield Here To Pedestrians signs may be used together at the same crosswalk.

Section 2B.13 Speed Limit Signs (R2-1, R2-H2b)

Support:

Section 4511.21 of the Ohio Revised Code (ORC) establishes statutory speed limits, and prescribes how those speed limits may be altered when an engineering study determines that they do not fit the road and traffic conditions. The process by which an altered speed limit is established is typically referred to as speed zoning. This speed zoning process and the related forms are described in Part 12 of the ODOT "Traffic Engineering Manual" (TEM) (see Section 1A.11).

Standard:

As noted in ORC Section 4511.21 (see Appendix B2) speed zones (other than statutory speed limits) shall only be established on the basis of an engineering study that has been performed in accordance with traffic engineering practices. The engineering study shall include an analysis of the current speed distribution of free-flowing vehicles.

The Speed Limit (R2-1) sign (see Figure 2B-3) shall display the limit established by law, ordinance, regulation, or as adopted by the authorized agency based on engineering study. The speed limits displayed shall be in multiples of 5 mph.

Speed Limit (R2-1) signs, indicating speed limits for which posting is required by law, shall be located at the points of change from one speed limit to another.

Figure 2B-3. Speed Limit and Photo Enforcement Signs and Plaques

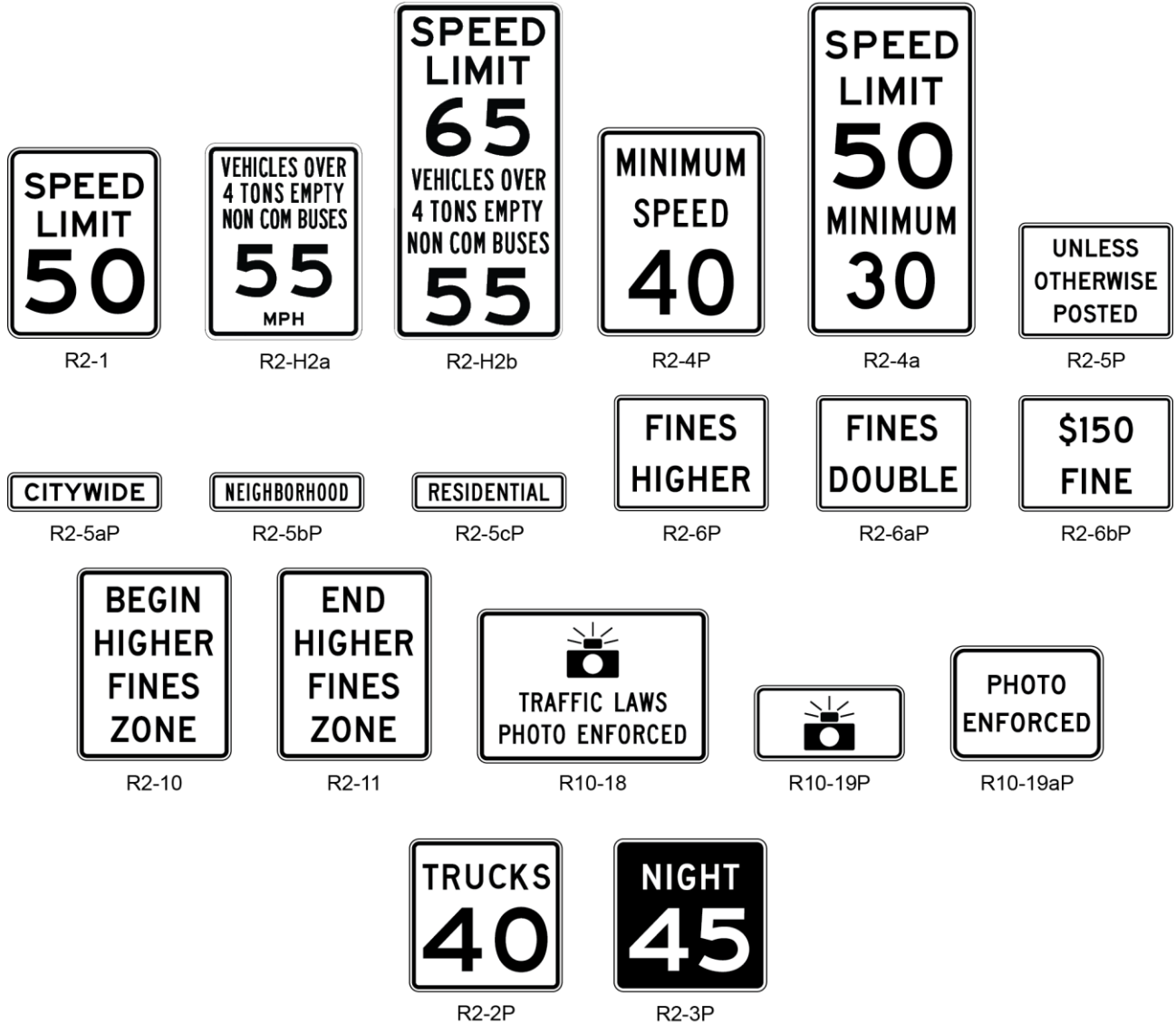

05 **At the downstream end of the section to which a speed limit applies, a Speed Limit sign showing the next speed limit shall be installed. Additional Speed Limit signs shall be installed beyond major intersections and at other locations where it is necessary to remind road users of the speed limit that is applicable.**

06 **Speed Limit signs indicating the statutory speed limits shall be installed at entrances to the State and, where appropriate, at jurisdictional boundaries in urban areas.**

Support:

07 In general, the maximum speed limits applicable to rural and urban roads are established:

- A. Statutorily – a maximum speed limit applicable to a particular class of road, such as freeways or city streets, that is established by State law; or
- B. As altered speed zones – based on engineering studies.

08 State statutory limits might restrict the maximum speed limit that can be established on a particular road, notwithstanding what an engineering study might indicate.

Option:

09 If a jurisdiction has a policy of installing Speed Limit signs in accordance with statutory requirements only on the streets that enter a city, neighborhood, or residential area to indicate the speed limit that is

applicable to the entire city, neighborhood, or residential area unless otherwise posted, a CITYWIDE (R2-5aP), NEIGHBORHOOD (R2-5bP), or RESIDENTIAL (R2-5cP) plaque may be mounted above the Speed Limit sign and an UNLESS OTHERWISE POSTED (R2-5P) plaque may be mounted below the Speed Limit sign (see Figure 2B-3).

Guidance:

- 10 *A Reduced Speed Limit Ahead (W3-5 or W3-5a) sign (see Section 2C.38) should be used to inform road users of a reduced speed zone where the speed limit is being reduced by more than 10 mph, or where engineering judgment indicates the need for advance notice to comply with the posted speed limit ahead.*
- 11 *Highway agencies should conduct engineering studies to reevaluate non-statutory speed limits on segments of their roadways that have undergone significant changes since the last review, such as the addition or elimination of parking or driveways, changes in the number of travel lanes, changes in the configuration of bicycle lanes, changes in traffic control signal coordination, or significant changes in traffic volumes.*
- 12 *No more than three speed limits should be displayed on any one Speed Limit sign or assembly.*
- 13 *When a speed limit within a speed zone is posted, it should be within 5 mph of the 85th-percentile speed of free-flowing traffic.*
- 14 *Speed studies for signalized intersection approaches should be taken outside the influence area of the traffic control signal, which is generally considered to be approximately 1/2 mile, to avoid obtaining skewed results for the 85th-percentile speed.*

Support:

- 15 *Advance warning signs and other traffic control devices to attract the motorist's attention to a signalized intersection are usually more effective than a reduced speed limit zone.*

Guidance:

- 16 *An advisory speed plaque (see Section 2C.08) mounted below a warning sign should be used to warn road users of an advisory speed for a roadway condition. A Speed Limit sign should not be used for this situation.*

Option:

- 17 *Factors that may be considered when establishing or reevaluating speed limits include the following:*
- A. Road characteristics, shoulder condition, grade, alignment, and sight distance;
 - B. The pace;
 - C. Roadside development and environment;
 - D. Parking practices and pedestrian activity; and
 - E. Reported crash experience for at least a 12-month period.
- 18 *Two types of Speed Limit signs may be used: one to designate passenger car speeds, including any nighttime information or minimum speed limit that might apply; and the other to show any special speed limits for trucks and other vehicles.*
- 19 *A combination 65/55 Speed Limit (R2-H2b) sign may be used in lieu of a side-by-side installation of the R2-1 with the R2-H2a (see Figure 2B-3).*
- 20 *A changeable message sign that displays to approaching drivers the speed at which they are traveling may be installed in conjunction with a Speed Limit sign.*

Guidance:

- 21 *If a changeable message sign displaying approach speeds is installed, the legend YOUR SPEED XX MPH or such similar legend should be displayed. The color of the changeable message legend should be a yellow legend on a black background or the reverse of these colors.*

Support:

- 22 *Information about the speed zoning process and copies of the related forms are also available by contacting the ODOT District Office. Contact information for the ODOT District Offices is available from the ODOT website (see the web address on page ii).*
- 23 *Advisory Speed signs and plaques are discussed in Sections 2C.08 and 2C.14. Temporary Traffic Control Zone Speed signs are discussed in Part 6. The WORK ZONE (G20-5aP) plaque intended for installation*

above a Speed Limit sign is discussed in Section 6F.12. School Speed Limit signs are discussed in Section 7B.15.

Section 2B.14 Truck Speed Limit Plaque and Signs (R2-2P, R2-H2a)

Standard:

- 01 **Where a special speed limit applies to trucks or other vehicles, the legend TRUCKS XX or such similar legend shall be displayed below the legend SPEED LIMIT XX on the same sign or on a separate R2-2P plaque (see Figure 2B-3) below the standard legend.**

Guidance:

- 02 *When used, the VEHICLES OVER 4 TONS EMPTY NON COM BUSES 55 MPH (R2-H2a) sign (see Figure 2B-3) should be erected adjacent to the Speed Limit sign.*

Option:

- 03 As noted in Section 2B.13, a combination 65/55 Speed Limit (R2-H2b) sign may be used (see Figure 2B-3) instead of a side-by-side installation of the R2-1 with the R2-H2a.

Section 2B.15 Night Speed Limit Plaque (R2-3P)

Standard:

- 01 **Where different speed limits are prescribed for day and night, both limits shall be posted.**

Guidance:

- 02 *A Night Speed Limit (R2-3P) plaque (see Figure 2B-3) should be reversed using a white retroreflectorized legend and border on a black background.*

Option:

- 03 A Night Speed Limit plaque may be combined with or installed below the standard Speed Limit (R2-1) sign.

Section 2B.16 Minimum Speed Limit Plaque (R2-4P)

Standard:

- 01 **A Minimum Speed Limit (R2-4P) plaque (see Figure 2B-3) shall be displayed only in combination with a Speed Limit sign.**

- 02 **Minimum speed limits shall be established in accordance with ORC Section 4511.22 (see Appendix B2).**

Option:

- 03 Where engineering judgment determines that slow speeds on a highway might impede the normal and reasonable movement of traffic, the Minimum Speed Limit plaque may be installed below a Speed Limit (R2-1) sign to indicate the minimum legal speed. If desired, the Speed Limit sign and the Minimum Speed Limit plaque may be combined on the R2-4a sign (see Figure 2B-3).

Section 2B.17 Higher Fines Signs and Plaque (R2-6P, R2-10, R2-11)

Standard:

- 01 **If increased fines are imposed for traffic violations within a designated zone of a roadway, a BEGIN HIGHER FINES ZONE (R2-10) sign (see Figure 2B-3) or a FINES HIGHER (R2-6P) plaque (see Figure 2B-3) shall be used to provide notice to road users. If used, the FINES HIGHER plaque shall be mounted below an applicable regulatory or warning sign in a temporary traffic control zone, a school zone, or other applicable designated zone.**

- 02 **If an R2-10 sign or an R2-6P plaque is posted to provide notice of increased fines for traffic violations, an END HIGHER FINES ZONE (R2-11) sign (see Figure 2B-3) shall be installed at the downstream end of the zone to provide notice to road users of the termination of the increased fines zone.**

Guidance:

- 03 *If used, the BEGIN HIGHER FINES ZONE sign or FINES HIGHER plaque should be located at the beginning of the temporary traffic control zone, school zone, or other applicable designated zone and just beyond any interchanges, major intersections, or other major traffic generators.*

Standard:

- 04 **The Higher Fines signs and plaque shall have a black legend and border on a white rectangular background. All supplemental plaques mounted below the Higher Fines signs and plaque shall have a black legend and border on a white rectangular background.**

Guidance:

- 05 *Agencies should limit the use of the Higher Fines signs and plaque to locations where work is actually underway, or to locations where the roadway, shoulder, or other conditions, including the presence of a school zone require a speed reduction or extra caution on the part of the road user.*

Option:

- 06 Alternate legends such as BEGIN (or END) DOUBLE FINES ZONE may also be used for the R2-10 and R2-11 signs.

Figure 2B-4. Movement Prohibition and Lane Control Signs and Plaques

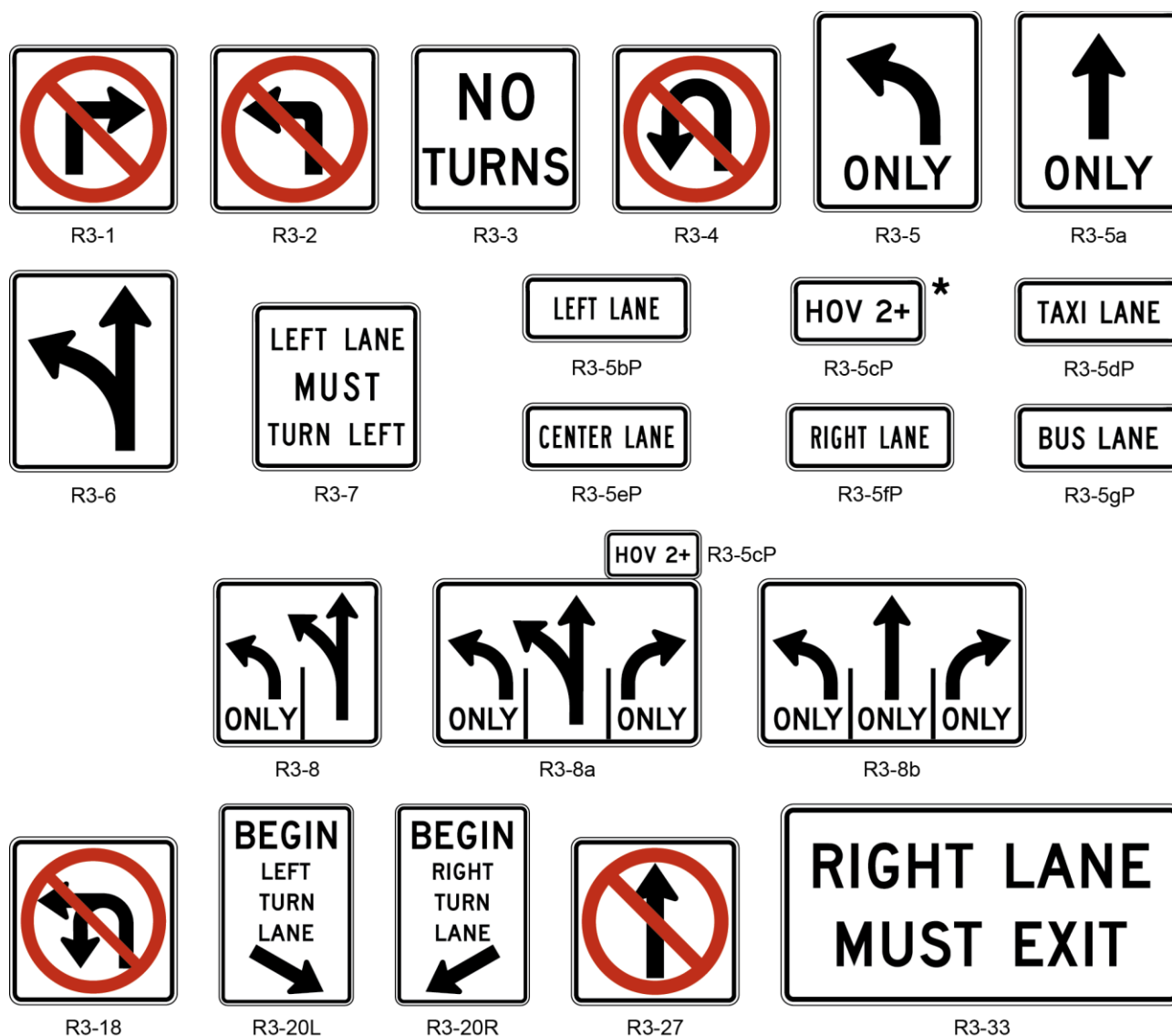

* The diamond symbol may be used instead of the "HOV" word message. The minimum vehicle occupancy level may vary, such as 2+, 3+, 4+. The words "LANE" or "ONLY" may be used with this sign when appropriate.

- 07 The legend FINES HIGHER on the R2-6P plaque may be replaced by FINES DOUBLE (R2-6aP), \$XX FINE (R2-6bP), or another legend appropriate to the specific regulation (see Figure 2B-3).
- 08 The following may be mounted below an R2-10 sign or R2-6P plaque:
- A. A supplemental plaque specifying the times that the higher fines are in effect (similar to the S4-1P plaque shown in Figure 7B-1), or
 - B. A supplemental plaque WHEN CHILDREN (WORKERS) ARE PRESENT, or
 - C. A supplemental plaque WHEN FLASHING if used in conjunction with a yellow flashing beacon.

Support:

- 09 Section 6F.12 contains information regarding other signs and plaques associated with increased fines for traffic violations in temporary traffic control zones. Section 7B.10 contains information regarding other signs and plaques associated with increased fines for traffic violations in designated school zones.

Section 2B.18 Movement Prohibition Signs (R3-1 through R3-4, R3-18, and R3-27)

Standard:

- 01 **Except as provided in Paragraphs 11 and 13, where specific movements are prohibited, Movement Prohibition signs shall be installed.**

Guidance:

- 02 *Movement Prohibition signs should be placed where they will be most easily seen by road users who might be intending to make the movement.*
- 03 *If No Right Turn (R3-1) signs (see Figure 2B-4) are used, at least one should be placed over the roadway or at a right-hand corner of the intersection.*
- 04 *If No Left Turn (R3-2) signs (see Figure 2B-4) are used, at least one should be placed either over the roadway, at the far left-hand corner of the intersection, on a median, or in conjunction with the STOP sign or YIELD sign located on the near right-hand corner.*
- 05 *Except as provided in Item C of Paragraph 9 for signalized locations, if NO TURNS (R3-3) signs (see Figure 2B-4) are used, two signs should be used, one at a location specified for a No Right Turn sign and one at a location specified for a No Left Turn sign.*
- 06 *If No U-Turn (R3-4) signs (see Figure 2B-4) or combination No U-Turn/No Left Turn (R3-18) signs (see Figure 2B-4) are used, at least one should be used at a location specified for No Left Turn signs.*

Option:

- 07 If both left turns and U-turns are prohibited, the combination No U-Turn/No Left Turn (R3-18) sign (see Figure 2B-4) may be used instead of separate R3-2 and R3-4 signs.

Guidance:

- 08 *If No Straight Through (R3-27) signs (see Figure 2B-4) are used, at least one should be placed either over the roadway or at a location where it can be seen by road users who might be intending to travel straight through the intersection.*
- 09 *If turn prohibition signs are installed in conjunction with traffic control signals:*
- A. *The No Right Turn sign should be installed adjacent to a signal face viewed by road users in the right-hand lane.*
 - B. *The No Left Turn (or No U-Turn or combination No U-Turn/No Left Turn) sign should be installed adjacent to a signal face viewed by road users in the left lane.*
 - C. *A NO TURNS sign should be placed adjacent to a signal face viewed by all road users on that approach, or two signs should be used.*

Option:

- 10 If turn prohibition signs are installed in conjunction with traffic control signals, an additional Movement Prohibition sign may be post-mounted to supplement the sign mounted overhead.
- 11 Where ONE WAY signs are used (see Section 2B.40), No Left Turn and No Right Turn signs may be omitted.

12 When the movement restriction applies during certain time periods only, the following Turn Prohibition signing alternatives may be used and are listed in order of preference:

- A. Changeable message signs, especially at signalized intersections.
- B. Permanently mounted signs incorporating a supplementary legend showing the hours and days during which the prohibition is applicable.
- C. Portable signs, installed by proper authority, located off the roadway at each corner of the intersection. The portable signs are only to be used during the time that the turn prohibition is applicable.

13 Movement Prohibition signs may be omitted at a ramp entrance to an expressway or a channelized intersection where the design is such as to indicate clearly the one-way traffic movement on the ramp or turning lane.

Standard:

14 **The No Left Turn (R3-2) sign, the No U-Turn (R3-4) sign, and the combination No U-Turn/No Left Turn (R3-18) sign shall not be used at approaches to roundabouts to prohibit drivers from turning left onto the circulatory roadway of a roundabout.**

Support:

15 At roundabouts, the use of R3-2, R3-4, or R3-18 signs to prohibit left turns onto the circulatory roadway might confuse drivers about the possible legal turning movements around the roundabout. Roundabout Directional Arrow (R6-4 series) signs (see Section 2B.43) and/or ONE WAY (R6-1R or R6-2R) signs are the appropriate signs to indicate the travel direction within a roundabout.

Section 2B.19 Intersection Lane Control Signs (R3-5 through R3-8)

Standard:

01 **Intersection Lane Control signs, if used, shall require road users in certain lanes to turn, shall permit turns from a lane where such turns would otherwise not be permitted, shall require a road user to stay in the same lane and proceed straight through an intersection, or shall indicate permitted movements from a lane.**

02 **Intersection Lane Control signs (see Figure 2B-4) shall have three applications:**

- A. Mandatory Movement Lane Control (R3-5, R3-5a, and R3-7) signs;**
- B. Optional Movement Lane Control (R3-6) sign; and**
- C. Advance Intersection Lane Control (R3-8 series) signs.**

Support:

03 ORC Section 4511.36 (see Appendix B2) addresses turns at intersections.

Guidance:

04 *When Intersection Lane Control signs are mounted overhead, each sign should be placed over the lane or a projection of the lane to which it applies.*

05 *On signalized approaches where through lanes that become mandatory turn lanes, multiple-lane turns that include shared lanes for through and turning movements, or other lane-use regulations are present that would be unexpected by unfamiliar road users, overhead lane control signs should be installed at the signalized location over the appropriate lanes or projections thereof and in advance of the intersection over the appropriate lanes.*

06 *Where overhead mounting on the approach is impractical for the advance and/or intersection lane-use signs, one of the following alternatives should be employed:*

- A. At locations where through lanes become mandatory turn lanes, a mandatory movement lane control (R3-7) sign should be post-mounted on the left-hand side of the roadway where a through lane is becoming a mandatory left-turn lane on a one-way street or where a median of sufficient width for the signs is available, or on the right-hand side of the roadway where a through lane is becoming a mandatory right-turn lane.*
- B. At locations where a through lane is becoming a mandatory left-turn lane on a two-way street where a median of sufficient width for the signs is not available, and at locations where multiple-lane turns that include shared lanes for through and turning movements are present, an Advance Intersection*

Lane Control (R3-8 series) sign should be post-mounted in a prominent location in advance of the intersection, and consideration should be given to the use of an oversized version in accordance with Table 2B-1.

Standard:

07 **Use of an overhead sign for one approach lane shall not require installation of overhead signs for the other lanes of that approach.**

Option:

08 Where the number of through lanes on an approach is two or less, the Intersection Lane Control (R3-5, R3-6, or R3-8 series) signs may be overhead or post-mounted.

09 Intersection Lane Control signs may be omitted where:

- A. A turn bay has been provided by physical construction or pavement markings, and
- B. Only the road users using such turn bays are permitted to make a turn in that direction.

10 At roundabouts, Intersection Lane Control (R3-5, R3-6, and R3-8 series) signs may display any of the arrow symbol options shown in Figure 2B-5.

Section 2B.20 Mandatory Movement Lane Control Signs (R3-5, R3-5a, R3-7, R3-20)

Standard:

01 **If used, the Mandatory Movement Lane Control (R3-5, R3-5a, and R3-7) sign (see Figure 2B-4) shall indicate only the single vehicle movement that is required from the lane. If used, the Mandatory Movement Lane Control sign shall be located in advance of the intersection, such as near the upstream end of the mandatory movement lane, and/or at the intersection where the regulation applies. When the mandatory movement applies to lanes exclusively designated for HOV traffic, the R3-5cP supplemental plaque shall be used. When the mandatory movement applies to lanes that are not HOV facilities, but are lanes exclusively designated for buses and/or taxis, the word message R3-5dP and/or R3-5gP supplemental plaques shall be used.**

02 **The Mandatory Movement Lane Control (R3-7) sign shall include the legend RIGHT (LEFT) LANE MUST TURN RIGHT (LEFT). The Mandatory Movement Lane Control (R3-5 and R3-5a) shall include the legend ONLY.**

03 **The R3-7 word message sign shall be for post-mounting only.**

04 **Where the number of lanes available to through traffic on an approach is three or more, Mandatory Movement Lane Control (R3-5 and R3-5a) symbol signs, if used, shall be mounted overhead over the specific lanes to which they apply (see Section 2B.19).**

Figure 2B-5. Intermediate Lane Control Sign Arrow Options for Roundabouts

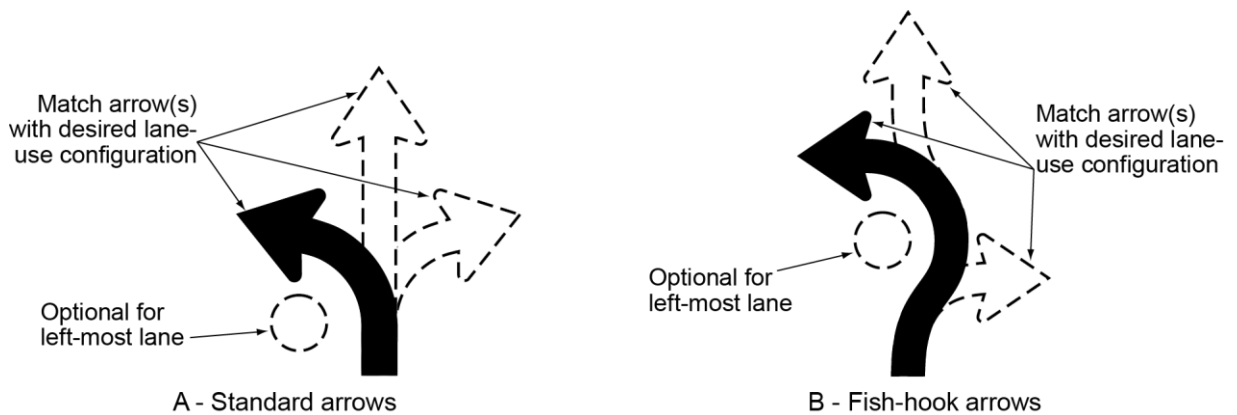

Guidance:

05 *If the R3-5 or R3-5a sign is post-mounted on an approach with two or fewer through lanes, a supplemental plaque (see Figure 2B-4), such as LEFT LANE (R3-5bP), HOV 2+ (R3-5cP), TAXI LANE (R3-5dP), CENTER LANE (R3-5eP), RIGHT LANE (R3-5fP), BUS LANE (R3-5gP), or BOTH LANES, should be added above the sign to indicate the specific lane to which the mandatory movement applies. If Mandatory Lane Movement Control (R3-5) symbol signs with supplemental R3-5bP or R3-5fP plaques are used, they should be mounted adjacent to and along only the full width portion of the turn lane.*

06 *The use of the Mandatory Movement Lane Control (R3-7) word message sign should be limited to only locations that are adjacent to the full-width portion of a mandatory turn lane. The R3-7 sign should not be installed adjacent to a through lane in advance of a turn bay taper or adjacent to a turn bay taper.*

07 *Mandatory Movement Lane Control signs should be accompanied by lane use arrow markings, especially where traffic volumes are high, where there is a high percentage of commercial vehicles, or where other distractions exist.*

Option:

08 The Straight Through Only (R3-5a) sign may be used to require a road user in a particular lane to proceed straight through an intersection.

09 When the Mandatory Movement Lane Control (R3-5) sign for a left-turn lane is installed back-to-back with a Keep Right (R4-7) sign, the dimensions of the Mandatory Movement Lane Control sign may be the same as the Keep Right sign.

10 The diamond symbol may be used instead of the word message HOV on the R3-5cP supplemental plaque.

11 The BEGIN RIGHT TURN LANE (R3-20R) sign (see Figure 2B-4) may be post-mounted on the right-hand side of the roadway at the upstream end of the turn lane taper of a mandatory right-turn lane. The BEGIN LEFT TURN LANE (R3-20L) sign (see Figure 2B-4) may be post-mounted on a median (or on the left-hand side of the roadway for a one-way street) at the upstream end of the turn lane taper of a mandatory left-turn lane.

Section 2B.21 Optional Movement Lane Control Sign (R3-6)**Standard:**

01 **If used, the Optional Movement Lane Control (R3-6) sign (see Figure 2B-4) shall be used for two or more movements from a specific lane or to emphasize permitted movements. If used, the Optional Movement Lane Control sign shall be located in advance of the intersection, such as near the upstream end of an adjacent mandatory movement lane, and/or at the intersection where the regulation applies.**

02 **If used, the Optional Movement Lane Control sign shall indicate all permissible movements from specific lanes.**

03 **Optional Movement Lane Control signs shall be used for two or more movements from a specific lane where a movement, not normally allowed, is permitted.**

04 **The Optional Movement Lane Control sign shall not be used alone to effect a turn prohibition.**

05 **Where the number of lanes available to through traffic on an approach is three or more, an Optional Movement Lane Control (R3-6) sign, if used, shall be mounted overhead over the specific lane to which it applies (see Section 2B.19).**

Guidance:

06 *If the Optional Movement Lane Control sign is post-mounted on an approach with two or fewer through lanes, a supplemental plaque (see Figure 2B-4), such as LEFT LANE (R3-5bP), HOV 2+ (R3-5cP), TAXI LANE (R3-5dP), CENTER LANE (R3-5eP), RIGHT LANE (R3-5fP), or BUS LANE (R3-5gP), should be added above the R3-6 sign to indicate the specific lane from which the optional movements can be made.*

Guidance:

07 *If the Optional Movement Lane Control sign is post-mounted on an approach with two or fewer through lanes, a supplemental plaque (see Figure 2B-4), such as LEFT LANE (R3-5bP), HOV 2+ (R3-5cP), TAXI LANE (R3-5dP), CENTER LANE (R3-5eP), RIGHT LANE (R3-5fP), or BUS LANE (R3-5gP), should be added above the R3-6 sign to indicate the specific lane from which the optional movements can be made.*

Standard:

- 08 **Because more than one movement is permitted from the lane, the word message ONLY shall not be used on an Optional Movement Lane Control sign.**

Section 2B.22 Advance Intersection Lane Control Signs (R3-8 Series)

Option:

- 01 Advance Intersection Lane Control (R3-8 Series) signs (see Figure 2B-4) may be used to indicate the configuration of all lanes ahead.
- 02 The word messages ONLY, THRU, ALL, or HOV 2+ may be used within the border in combination with the arrow symbols of the R3-8 sign series. The HOV 2+ (R3-5cP) supplemental plaque may be installed at the top outside border of the R3-8 sign over the applicable lane designation on the sign. The diamond symbol may be used instead of the word message HOV. The minimum allowable vehicle occupancy requirement may vary based on the level established for a particular facility.

Guidance:

- 03 *If used, an Advance Intersection Lane Control sign should be placed at an adequate distance in advance of the intersection so that road users can select the appropriate lane (see Figure 2A-4). If used, the Advance Intersection Lane Control sign should be installed either in advance of the tapers or at the beginning of the turn lane.*

Option:

- 04 An Advance Intersection Lane Control sign may be repeated closer to the intersection for additional emphasis.

Standard:

- 05 **Where three or more approach lanes are available to traffic, Advance Intersection Lane Control (R3-8 series) signs, if used, shall be post-mounted in advance of the intersection and shall not be mounted overhead (see Section 2B.19).**

Section 2B.23 RIGHT (LEFT) LANE MUST EXIT Sign (R3-33)

Option:

- 01 A RIGHT (LEFT) LANE MUST EXIT (R3-33) sign (see Figure 2B-4) may be used to supplement an overhead EXIT ONLY guide sign to inform road users that traffic in the right-hand (left-hand) lane of a roadway that is approaching a grade-separated interchange is required to depart the roadway on the exit ramp at the next interchange.

Support:

- 02 Section 2C.43 contains information regarding a warning sign that can be used in advance of lane drops at grade-separated interchanges.

Section 2B.24 Two-Way Left Turn Only Signs (R3-9a, R3-9b)*Guidance:*

- 01 *Two-Way Left Turn Only (R3-9a or R3-9b) signs (see Figure 2B-6) should be used in conjunction with the required pavement markings where a nonreversible lane is reserved for the exclusive use of left-turning vehicles in either direction and is not used for passing, overtaking, or through travel.*

Option:

- 02 The post-mounted R3-9b sign may be used as an alternate to or a supplement to the overhead R3-9a sign. The legend BEGIN or END may be used within the border of the main sign itself, or on an R3-9cP or R3-9dP plaque (see Figure 2B-6) mounted immediately above it.

Support:

- 03 Signing is especially helpful to drivers in areas where the two-way left turn only maneuver is new, in areas subject to environmental conditions that frequently obscure the pavement markings, and on peripheral streets with two-way left turn only lanes leading to an extensive system of routes with two-way left turn only lanes.

Figure 2B-6. Center and Reversible Lane Control Signs and Plaques

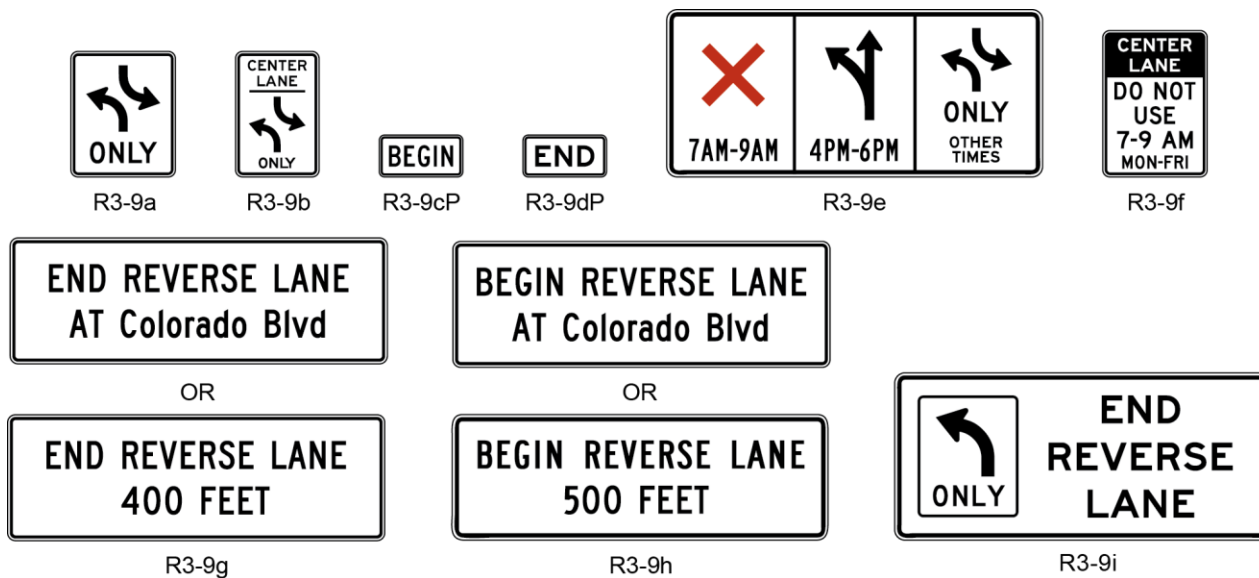

Section 2B.25 BEGIN and END Plaques (R3-9cP, R3-9dP)

Option:

- 01 The BEGIN (R3-9cP) or END (R3-9dP) plaque (see Figure 2B-6) may be used to supplement a regulatory sign to inform road users of the location where a regulatory condition begins or ends.

Standard:

- 02 If used, the BEGIN or END plaque shall be mounted directly above a regulatory sign.

Section 2B.26 Reversible Lane Control Signs (R3-9e through R3-9i)

Option:

- 01 A reversible lane may be used for through traffic (with left turns either permitted or prohibited) in alternating directions during different periods of the day, and the lane may be used for exclusive left turns in one or both directions during other periods of the day as well. Reversible Lane Control (R3-9e through R3-9i) signs (see Figure 2B-6) may be either static type or changeable message type. These signs may be either post-mounted or overhead.

Standard:

- 02 Post-mounted Reversible Lane Control signs shall be used only as a supplement to overhead signs or signals. Post-mounted signs shall be identical in design to the overhead signs and an additional legend such as CENTER LANE shall be added to the sign (R3-9f) to indicate which lane is controlled. For both word messages and symbols, this legend shall be at the top of the sign.

Table 2B-2. Meanings of Symbols and Legends on Reversible Lane Control Signs

Symbol / Word Message	Meaning
Red X on white background.	Lane Closed
Upward pointing black arrow on white background (if left turns are permitted, the arrow shall be modified to show left / through arrow).	Lane open for through travel and any turns not otherwise prohibited.
Black two-way left-turn arrows on white background and legend ONLY.	Lane may be used only for left turns in either direction (i.e., as a two-way left-turn lane).
Black single left-turn arrow on white background and legend ONLY.	Lane may be used only for left turns in one direction (without opposing left turns in the same lane).

Figure 2B-7. Location of Reversible Two-Way Left-Turn Signs

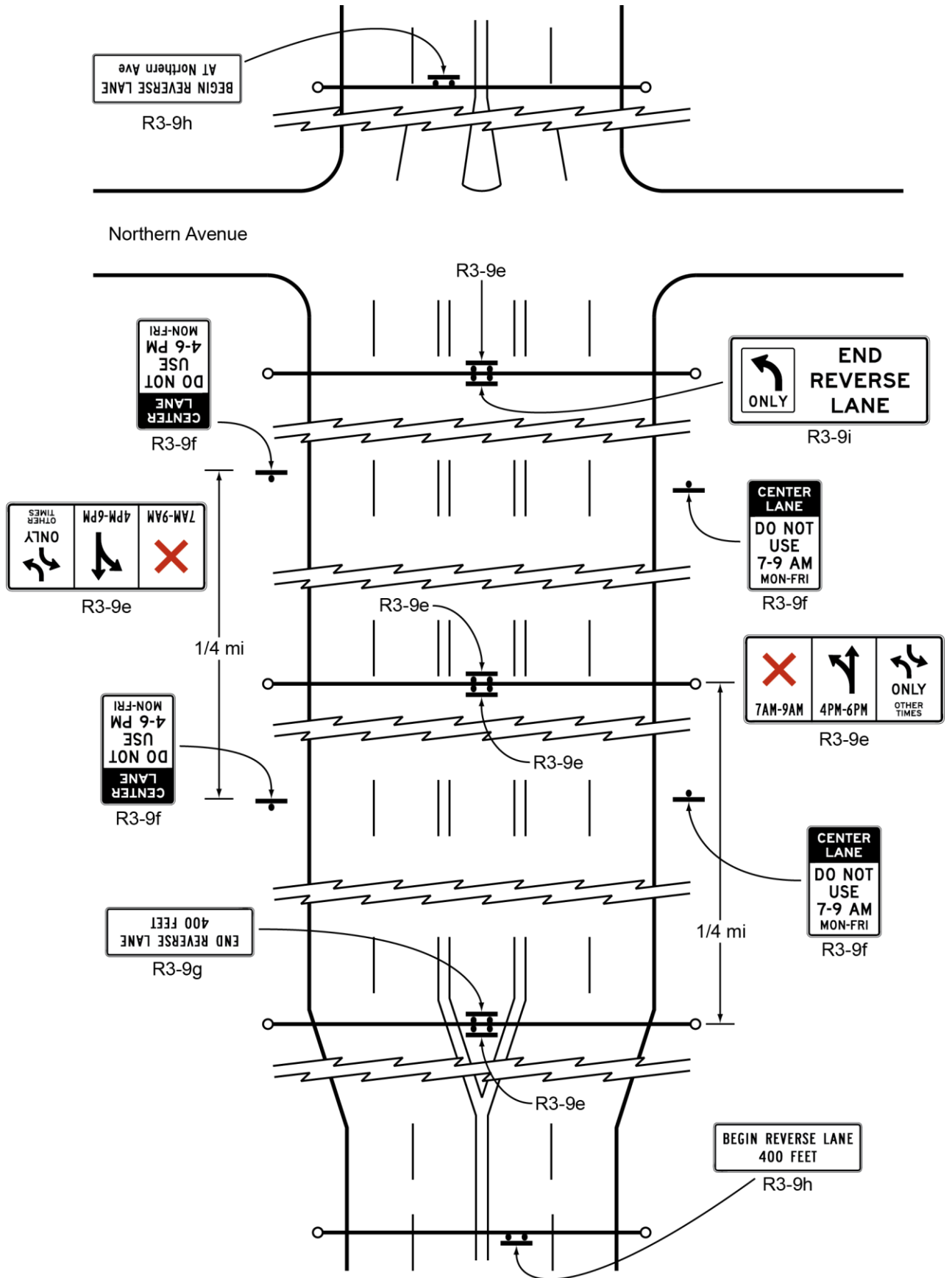

03 **Where it is determined by an engineering study that lane-use control signals or physical barriers are not necessary, the lane shall be controlled by overhead Reversible Lane Control signs (see Figure 2B-7).**

Option:

04 Reversing traffic flow may be controlled with pavement markings and Reversible Lane Control signs (without the use of lane control signals), when all of the following conditions are met:

- A. Only one lane is being reversed.
- B. An engineering study indicates that the use of Reversible Lane Control signs alone would result in an acceptable level of safety and efficiency.
- C. There are no unusual or complex operations in the reversible lane pattern.

Standard:

05 **Reversible Lane Control signs shall contain the legend or symbols designating the allowable uses of the lane and the time periods such uses are allowed. Where symbols and legends are used, their meanings shall be as shown in Table 2B-2.**

06 **Reversible Lane Control signs shall consist of a white background with a black legend and border, except for the R3-9e sign, where the color red is used.**

07 **Symbol signs, such as the R3-9e sign, shall consist of the appropriate symbol in the upper portion of the sign with the appropriate times of the day and days of the week below it. All times of the day and days of the week shall be accounted for on the sign to eliminate confusion to the road user.**

08 **In situations where more than one message is conveyed to the road user, such as on the R3-9e sign, the sign legend shall be arranged as follows:**

- A. The prohibition or restriction message is the primary legend and shall be on the top for word message signs and to the far left for symbol signs;
- B. The permissive use message shall be displayed as the second legend; and
- C. The OTHER TIMES message shall be displayed at the bottom for word message signs and to the far right for symbol signs.

Option:

09 The symbol signs may also include a downward pointing arrow with the legend THIS LANE. The term OTHER TIMES may be used for either the symbol or word message sign.

Standard:

10 **A Reversible Lane Control sign shall be mounted over the center of the lane that is being reversed and shall be perpendicular to the roadway alignment.**

11 **If the vertical or horizontal alignment is curved to the degree that a driver would be unable to see at least one sign, and preferably two signs, then additional overhead signs shall be installed. The placement of the signs shall be such that the driver will have a definite indication of the lanes specifically reserved for use at any given time. Special consideration shall be given to major generators introducing traffic between the normal sign placement.**

12 **Transitions at the entry to and exit from a section of roadway with reversible lanes shall be carefully reviewed, and advance signs shall be installed to notify or warn drivers of the boundaries of the reversible lane controls. The R3-9g or R3-9h signs shall be used for this purpose.**

Option:

13 More than one sign may be used at the termination of the reversible lane to emphasize the importance of the message (R3-9i).

Standard:

14 **Flashing beacons, if used to accentuate the overhead Reversible Lane Control signs, shall comply with the applicable requirements for flashing beacons in Chapter 4L.**

15 **When used in conjunction with Reversible Lane Control signs, the Turn Prohibition signs (R3-1 to R3-4, R3-18) shall be mounted overhead and separate from the Reversible Lane Control signs. The Turn Prohibition signs shall be designed and installed in accordance with Section 2B.18.**

Figure 2B-8. Jughandle Regulatory Signs

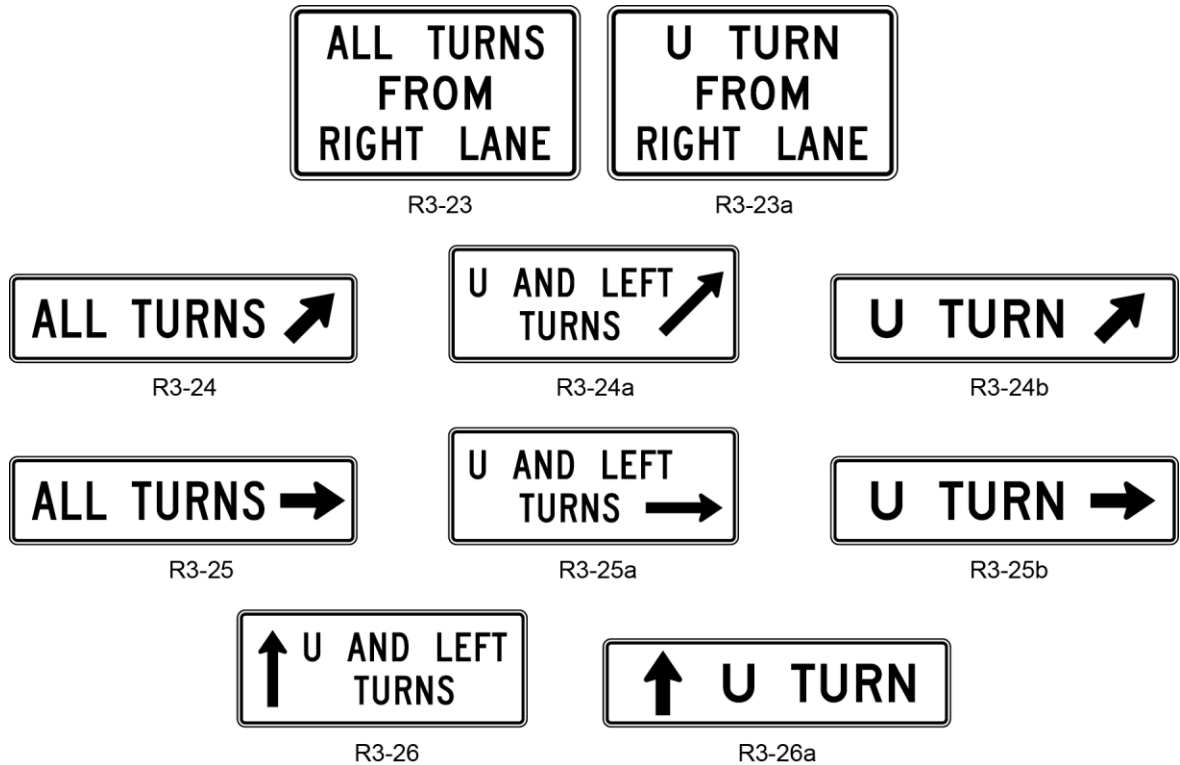

Guidance:

- 16 For additional emphasis, a supplemental plaque stating the distance of the prohibition, such as NEXT 1 MILE, should be added to the Turn Prohibition signs that are used in conjunction with Reversible Lane Control signs.
- 17 If used, overhead signs should be located at intervals not greater than 1/4 mile. The bottom of the overhead Reversible Lane Control signs should not be more than 19 feet above the pavement grade.
- 18 Where more than one sign is used at the termination of a reversible lane, they should be at least 250 feet apart. Longer distances between signs are appropriate for streets with speeds over 35 mph, but the separation should not exceed 1,000 feet.
- 19 Because left-turning vehicles have a significant impact on the safety and efficiency of a reversible lane operation, if an exclusive left-turn lane or two-way left-turn lane cannot be incorporated into the lane-use pattern for a particular peak or off-peak period, consideration should be given to prohibiting left turns and U-turns during that time period.

Section 2B.27 Jughandle Signs (R3-23, R3-24, R3-25, and R3-26 Series)

Support:

- 01 A jughandle turn is a left-turn or U-turn that because of special geometry is made by initially making a right turn. This type of turn can increase the operational efficiency of a roadway by eliminating the need for exclusive left-turn lanes and can increase the operational efficiency of a traffic control signal by eliminating the need for protected left-turn phases. A jughandle turn can also provide an opportunity for trucks and commercial vehicles to make a U-turn where the median and roadway are not of sufficient width to accommodate a traditional U-turn by these vehicles.

- 02 Figure 2B-8 shows the various signs that can be used for signing jughandle turns. Figure 2B-9 shows examples of regulatory and destination guide signing for various types of jughandle turns.

Standard:

- 03 On multi-lane roadways, since road users generally anticipate that they need to be in the left-hand lane when approaching a location where they desire to turn left or make a U-turn, an ALL TURNS

Figure 2B-9. Examples of Applications of Jughandle Regulatory and Guide Signing (Sheet 1 of 3)

A – Turns made prior to the intersection

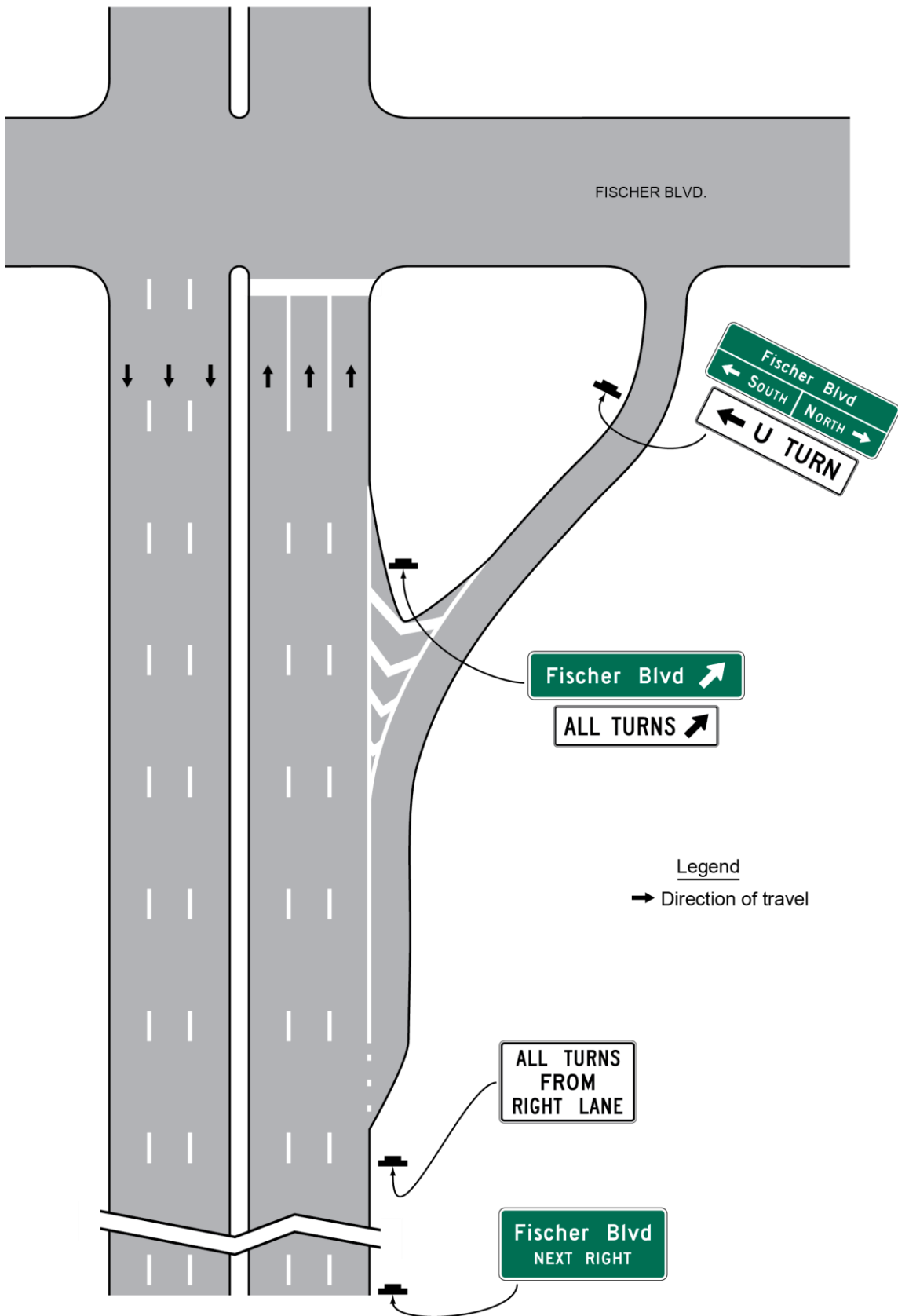

Figure 2B-9. Examples of Applications of Jughandle Regulatory and Guide Signing (Sheet 2 of 3)

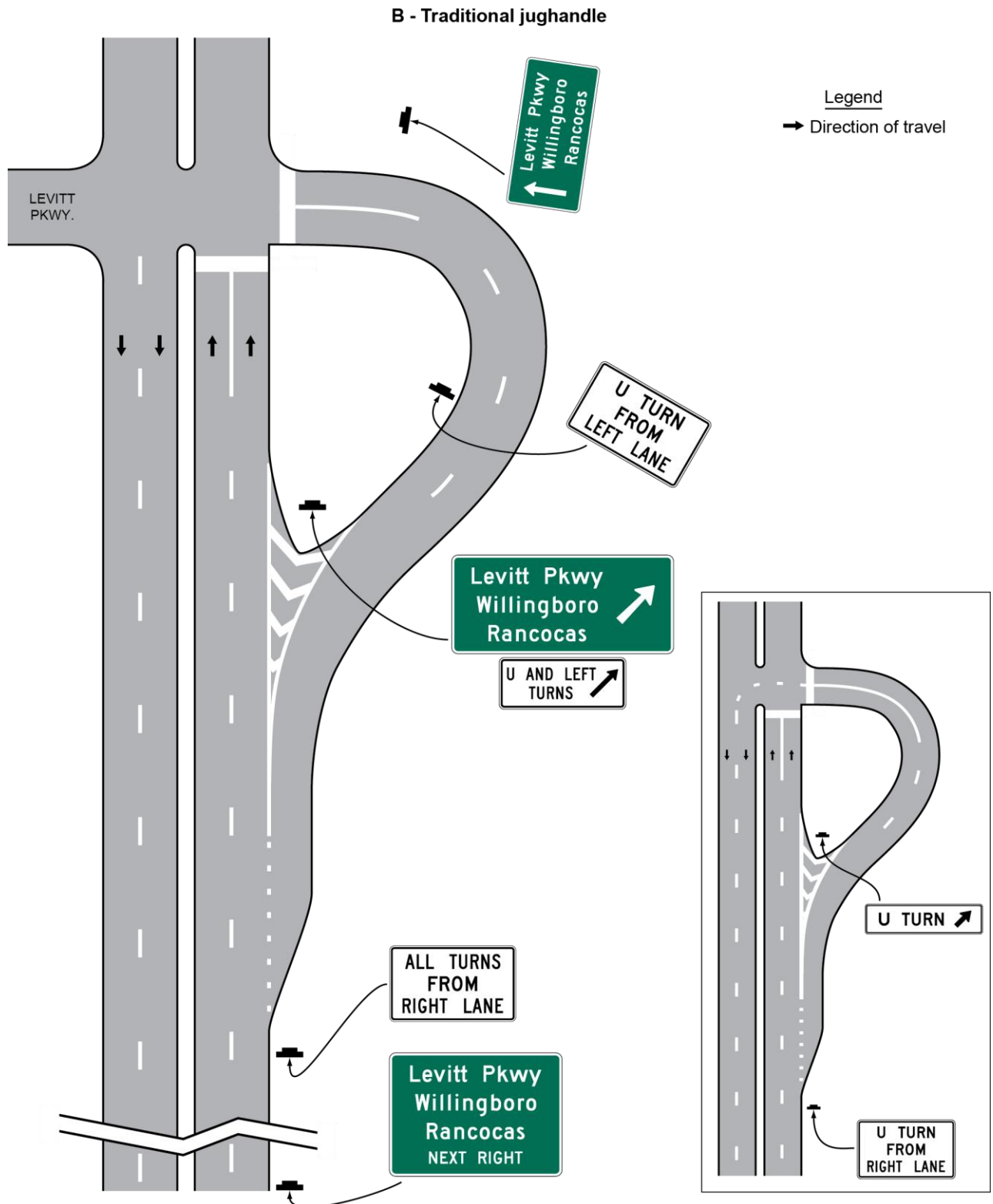
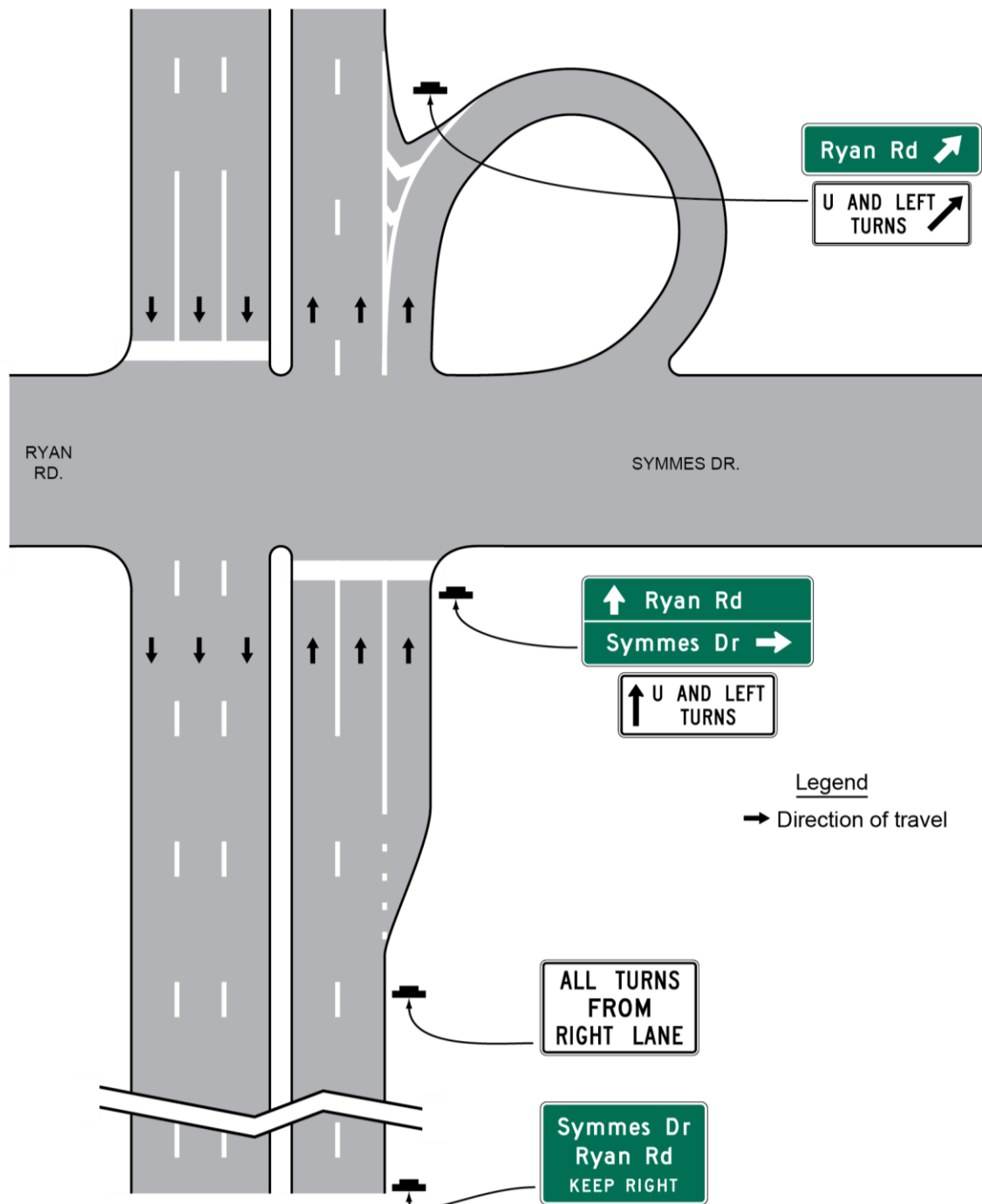

Figure 2B-9. Examples of Applications of Jughandle Regulatory and Guide Signing (Sheet 3 of 3)

C - Turns made beyond the intersection



FROM RIGHT LANE (R3-23) or a U TURN FROM RIGHT LANE (R3-23a) sign (see Figure 2B-9) shall be installed in advance of the location to inform drivers that left turns and/or U-turns will be made from the right-hand lane.

Option:

- 04 Where a median of sufficient width is available, supplemental regulatory or guide signs may also be placed on the left-hand side of the roadway.

Standard:

- 05 **An R3-24 series sign with an upward diagonal arrow pointing to the right if the jughandle entrance is designed as an exit ramp (see Drawings A and B of Figure 2B-9) or an R3-25 series sign with a horizontal arrow pointing to the right if the jughandle entrance is designed as an intersection shall be installed on the right-hand side of the roadway at the entrance to the jughandle. The legend on the sign shall be ALL TURNS, U TURN, or U AND LEFT TURNS, as appropriate.**

- 06 **If the jughandle is designed such that the jughandle entrance is downstream of the location where the turn would normally have been made (see Drawing C of Figure 2B-9), an R3-26 series sign with an arrow pointing straight upward shall be installed on the right-hand side of the roadway at the intersection to inform road users that they need to proceed straight through the intersection in order to make a left turn or U-turn. The legend on the sign shall be U TURN or U AND LEFT TURNS, as appropriate.**

Support:

- 07 The R3-24, R3-25, and R3-26 series of signs are designed to be mounted below conventional guide signs.

- 08 Section 2C.14 contains information regarding the use of advisory exit and ramp speed signs for exit ramps.

- 09 Section 2D.39 contains information regarding the use of guide signs for jughandles.

Section 2B.28 DO NOT PASS Sign (R4-1)

Option:

- 01 The DO NOT PASS (R4-1) sign (see Figure 2B-10) may be used in addition to pavement markings (see Section 3B.02) to emphasize the restriction on passing. The DO NOT PASS sign may be used at the beginning of, and at intervals within, a zone through which sight distance is restricted or where other conditions make overtaking and passing inappropriate.

- 02 If signing is needed on the left-hand side of the roadway for additional emphasis, NO PASSING ZONE (W14-3) signs may be used (see Section 2C.45).

Support:

- 03 Standards for determining the location and extent of no-passing zone pavement markings are set forth in Section 3B.02.

Section 2B.29 PASS WITH CARE Sign (R4-2)

Guidance:

- 01 *The PASS WITH CARE (R4-2) sign (see Figure 2B-10) should be installed at the downstream end of a no-passing zone if a DO NOT PASS sign has been installed at the upstream end of the zone.*

Section 2B.30 SLOWER TRAFFIC KEEP RIGHT Sign (R4-3)

Option:

- 01 The SLOWER TRAFFIC KEEP RIGHT (R4-3) sign (see Figure 2B-10) may be used on multi-lane roadways to reduce unnecessary lane changing.

Guidance:

- 02 *If used, the SLOWER TRAFFIC KEEP RIGHT sign should be installed just beyond the beginning of a multi-lane pavement, and at selected locations where there is a tendency on the part of some road users to drive in the left-hand lane (or lanes) below the normal speed of traffic. This sign should not be used on the approach to an interchange or through an interchange area.*

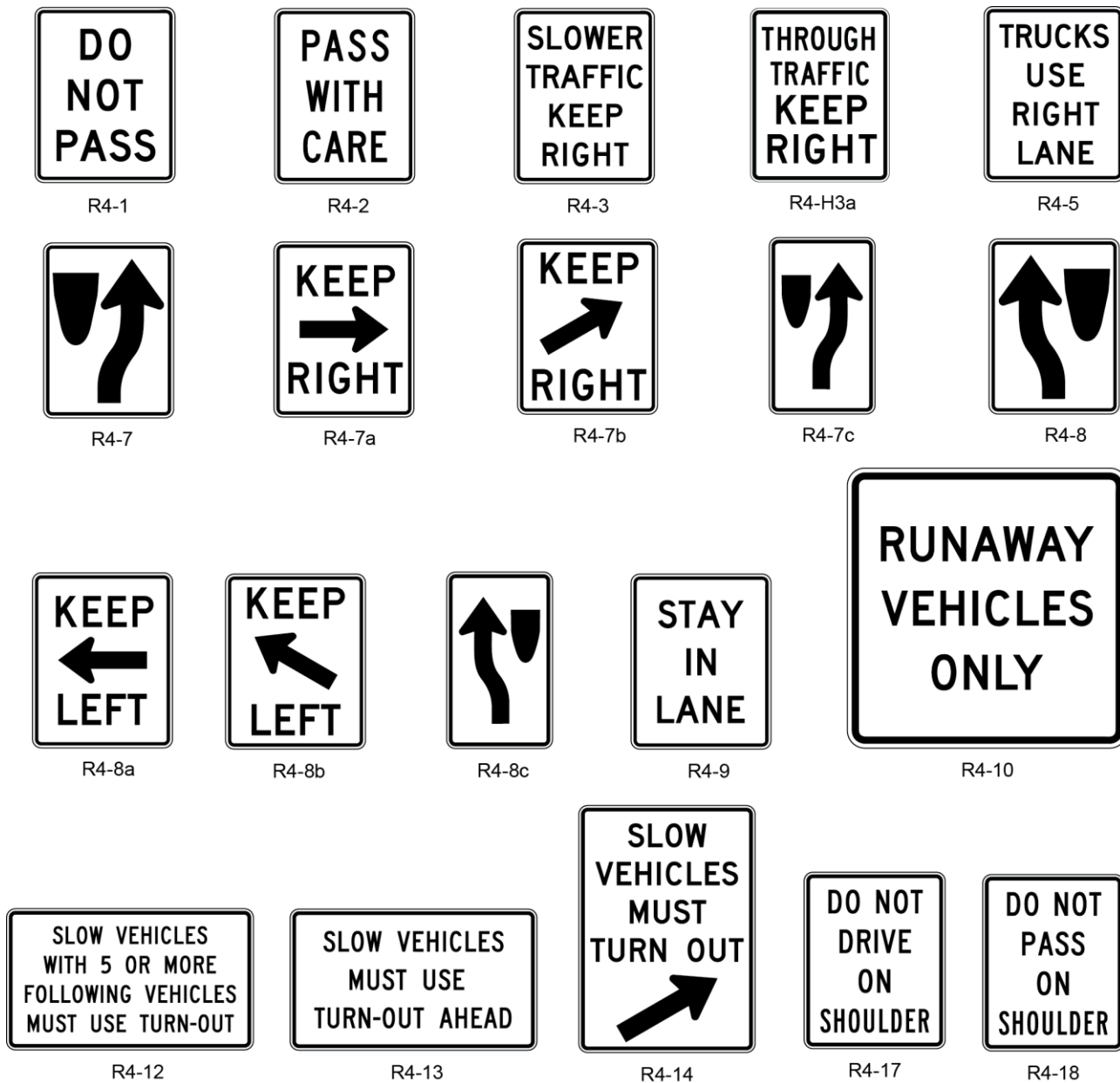
Figure 2B-10. Passing, Keep Right, and Truck Lane Signs**Section 2B.31 TRUCKS USE RIGHT LANE Sign (R4-5)***Guidance:*

- 01 If an extra lane has been provided for trucks and other slow-moving traffic, a *SLOWER TRAFFIC KEEP RIGHT* (R4-3) sign (see Figure 2B-10), *TRUCKS USE RIGHT LANE* (R4-5) sign (see Figure 2B-10), or other appropriate sign should be installed at the beginning of the lane.

Option:

- 02 The *SLOWER TRAFFIC KEEP RIGHT* sign may be used as a supplement or as an alternative to the *TRUCKS USE RIGHT LANE* sign. Both signs may be used on multi-lane roadways to improve capacity and reduce lane changing.
- 03 The *TRUCKS USE RIGHT LANE* (R4-5) sign may be used on multi-lane roadways to reduce unnecessary lane changing.

- 04 *If an extra lane has been provided for trucks and other slow-moving traffic, a Lane Ends sign (see Section 2C.42) should be installed in advance of the point where the extra lane ends. Appropriate pavement markings should be installed at both the upstream and downstream ends of the extra lane (see Section 3B.09 and Figure 3B-14).*

Support:

- 05 Section 2D.51 contains information regarding advance information signs for extra lanes that have been provided for trucks and other slow-moving traffic.

Section 2B.32 Keep Right and Keep Left Signs (R4-H3a, R4-7, R4-8)

Option:

- 01 The Keep Right (R4-7) sign (see Figure 2B-10) may be used at locations where it is necessary for traffic to pass only to the right-hand side of a roadway feature or obstruction. The Keep Left (R4-8) sign (see Figure 2B-10) may be used at locations where it is necessary for traffic to pass only to the left-hand side of a roadway feature or obstruction.

Guidance:

- 02 *At locations where it is not readily apparent that traffic is required to keep to the right, a Keep Right sign should be used.*
- 03 *If used, the Keep Right sign should be installed as close as practical to approach ends of raised medians, parkways, islands, and underpass piers. The sign should be mounted on the face of or just in front of a pier or other obstruction separating opposite directions of traffic in the center of the highway such that traffic will have to pass to the right-hand side of the sign.*

Standard:

- 04 **The Keep Right sign shall not be installed on the right-hand side of the roadway in a position where traffic must pass to the left-hand side of the sign.**

Option:

- 05 The Keep Right sign may be omitted at intermediate ends of divisional islands and medians.
- 06 Word message KEEP RIGHT (LEFT) with an arrow signs (see Figure 2B-10) may be used instead of the corresponding R4-7 or R4-8 symbol signs.
- 07 Where the obstruction obscures the Keep Right sign, the minimum placement height may be increased for better sign visibility.
- 08 A narrow Keep Right (R4-7c) sign (see Figure 2B-10) may be installed on the approach end of a median island that is less than 4 feet wide at the point where the sign is to be located.

Standard:

- 09 **A narrow Keep Right (R4-7c) sign shall not be installed on a median island that has a width of 4 feet or more at the point where the sign is to be located.**

Support:

- 10 Within the medians of divided highway intersections (see Figures 2B-16 and 2B-17), it is desirable to angle KEEP RIGHT signs toward traffic turning left from the minor road approaches.

Guidance:

- 11 *Where through traffic should keep right or left, the THROUGH TRAFFIC KEEP RIGHT/LEFT (R4-H3a) sign should be used (see Figure 2B-10).*

Section 2B.33 STAY IN LANE Sign (R4-9)

Option:

- 01 A STAY IN LANE (R4-9) sign (see Figure 2B-10) may be used on multi-lane highways to direct road users to stay in their lane until conditions permit shifting to another lane.

Guidance:

- 02 *If a STAY IN LANE sign is used, it should be accompanied by a double solid white lane line(s) to prohibit lane changing.*

Section 2B.34 RUNAWAY VEHICLES ONLY Sign (R4-10)*Guidance:*

- 01 A *RUNAWAY VEHICLES ONLY (R4-10)* sign (see Figure 2B-10) should be installed near a truck escape (or runaway truck) ramp entrance to discourage other road users from entering the ramp.

Section 2B.35 Slow Vehicle Turn-Out Signs (R4-12, R4-13, R4-14)

Support:

- 01 On two-lane highways in areas where traffic volumes and/or vertical or horizontal curvature make passing difficult, turn-out areas are sometimes provided for the purpose of giving a group of faster vehicles an opportunity to pass a slow-moving vehicle.

Option:

- 02 A *SLOW VEHICLES WITH XX OR MORE FOLLOWING VEHICLES MUST USE TURN-OUT (R4-12)* sign (see Figure 2B-10) may be installed in advance of a turn-out area to inform drivers who are driving so slow that they have accumulated a specific number of vehicles behind them that they are required by the traffic laws of that State to use the turn-out to allow the vehicles following them to pass.

Support:

- 03 The specific number of vehicles displayed on the R4-12 sign provides law enforcement personnel with the information they need to enforce this regulation.

Option:

- 04 If an R4-12 sign has been installed in advance of a turn-out area, a *SLOW VEHICLES MUST USE TURN-OUT AHEAD (R4-13)* sign (see Figure 2B-10) may also be installed downstream from the R4-12 sign, but upstream from the turn-out area, to remind slow drivers that they are required to use a turn-out that is a short distance ahead.

Standard:

- 05 **If an R4-12 sign has been installed in advance of a turn-out area, a *SLOW VEHICLES MUST TURN OUT (with arrow) (R4-14)* sign (see Figure 2B-10) shall be installed at the entry point of the turn-out area.**

Support:

- 06 Section 2D.52 contains information regarding advance information signs for slow vehicle turn-out areas.

Section 2B.36 DO NOT DRIVE ON SHOULDER Sign (R4-17) and DO NOT PASS ON SHOULDER Sign (R4-18)

Option:

- 01 The *DO NOT DRIVE ON SHOULDER (R4-17)* sign (see Figure 2B-10) may be installed to inform road users that using the shoulder of a roadway as a travel lane is prohibited.

- 02 The *DO NOT PASS ON SHOULDER (R4-18)* sign (see Figure 2B-10) may be installed to inform road users that using the shoulder of a roadway to pass other vehicles is prohibited.

Section 2B.37 DO NOT ENTER Sign (R5-1)**Standard:**

- 01 **The *DO NOT ENTER (R5-1)* sign (see Figure 2B-11) shall be used where traffic is prohibited from entering a restricted roadway.**

Guidance:

- 02 *The DO NOT ENTER sign, if used, should be placed directly in view of a road user at the point where a road user could wrongly enter a divided highway, one-way roadway, or ramp (see Figure 2B-12). The sign should be mounted on the right-hand side of the roadway, facing traffic that might enter the roadway or ramp in the wrong direction.*

- 03 *If the DO NOT ENTER sign would be visible to traffic to which it does not apply, the sign should be turned away from, or shielded from, the view of that traffic.*

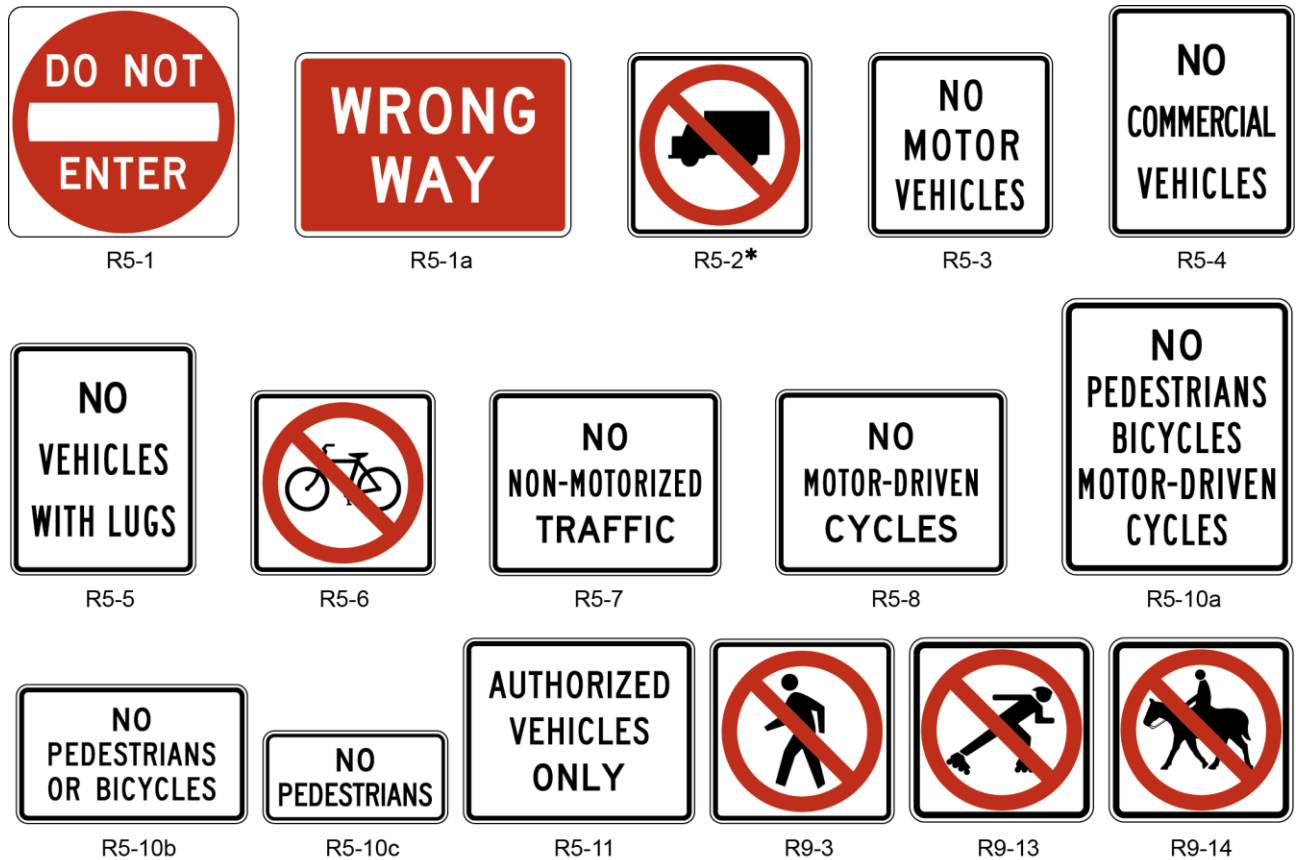
Figure 2B-11. Selective Exclusion Signs

* An optional word message sign is shown in the "Sign Designs and Markings Manual."

Option:

04 The DO NOT ENTER sign may be installed where it is necessary to emphasize the one-way traffic movement on a ramp or turning lane.

05 A second DO NOT ENTER sign on the left-hand side of the roadway may be used, particularly where traffic approaches from an intersecting roadway (see Figure 2B-12).

Support:

06 Section 2B.41 contains information regarding an optional lower mounting height for DO NOT ENTER signs that are located along an exit ramp facing a road user who is traveling in the wrong direction.

Section 2B.38 WRONG WAY Sign (R5-1a)

Standard:

01 The WRONG WAY (R5-1a) sign shall be used as noted in Section 2B.41, Paragraph 1.

Option:

02 The WRONG WAY (R5-1a) sign (see Figure 2B-11) may be used as a supplement to the DO NOT ENTER sign where an exit ramp intersects a crossroad or a crossroad intersects a one-way roadway in a manner that does not physically discourage or prevent wrong-way entry (see Figure 2B-12).

Guidance:

03 *If used, the WRONG WAY sign should be placed at a location along the exit ramp or the one-way roadway farther from the crossroad than the DO NOT ENTER sign (see Section 2B.41).*

Support:

04 Section 2B.41 contains information regarding an optional lower mounting height for WRONG WAY signs that are located along an exit ramp facing a road user who is traveling in the wrong direction.

Figure 2B-12. Locations of Wrong-Way Signing for Divided Highway with Median Widths of 30 Feet or Wider

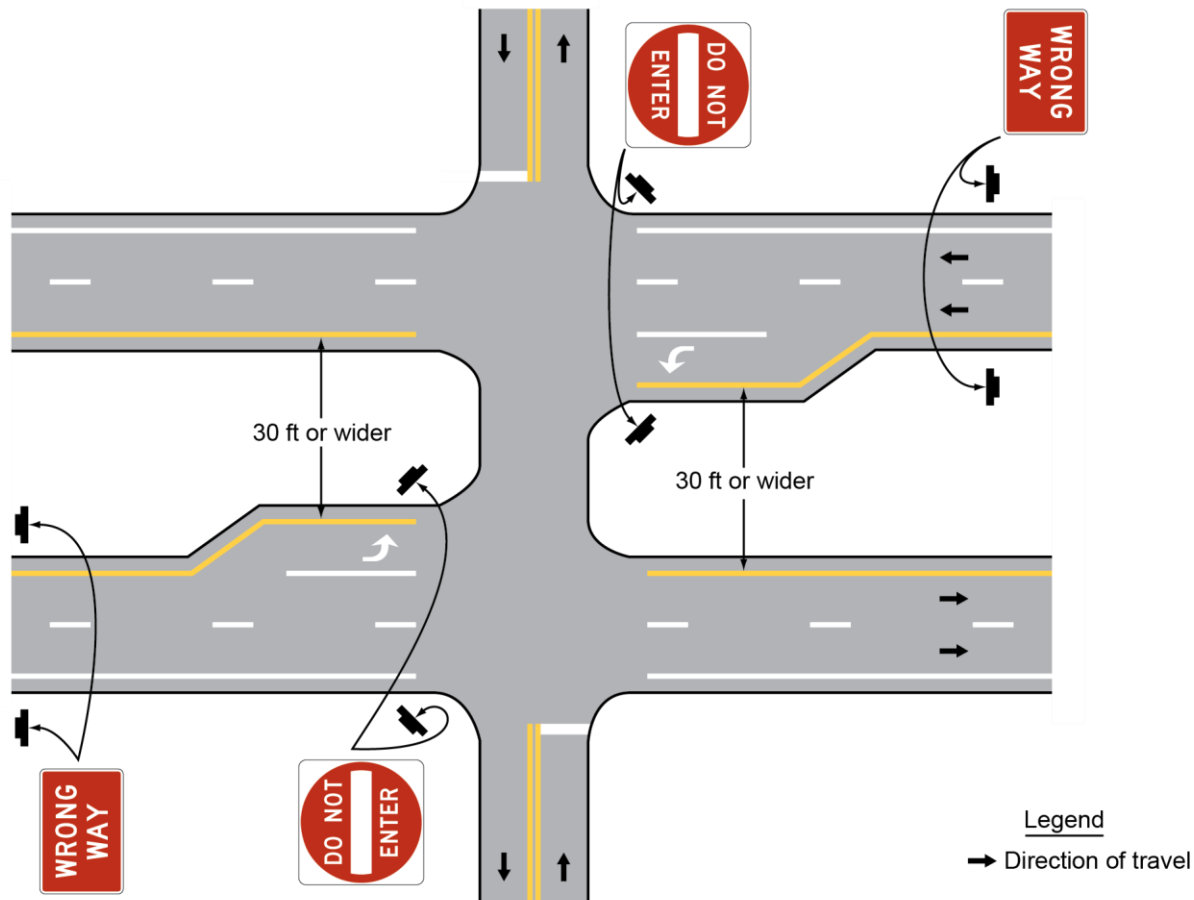

Section 2B.39 Selective Exclusion Signs

Support:

- 01 Selective Exclusion signs (see Figure 2B-11) give notice to road users that State or local statutes or ordinances exclude designated types of traffic from using particular roadways or facilities.
- 02 Section 4511.07 of the Ohio Revised Code (ORC) authorizes local municipalities to regulate the use of streets by vehicles; Section 4511.051 of the ORC addresses prohibitions on the use of freeways; and Section 4519.40 addresses prohibitions pertaining to snowmobiles and all purpose vehicles. These ORC sections have been reprinted in Appendix B2.

Standard:

- 03 **If used, Selective Exclusion signs shall clearly indicate the type of traffic that is excluded.**

Support:

- 04 Typical exclusion messages include (see Figure 2B-11 and Appendix C):
- A. No Trucks (R5-2);
 - B. NO MOTOR VEHICLES (R5-3);
 - C. NO COMMERCIAL VEHICLES (R5-4);
 - D. NO TRUCKS (VEHICLES) WITH LUGS (R5-5);
 - E. No Bicycles (R5-6);
 - F. NO NON-MOTORIZED TRAFFIC (R5-7);
 - G. NO MOTOR-DRIVEN CYCLES (R5-8);
 - H. No Pedestrians (R9-3),

- I. No Skaters (R9-13),
- J. No Equestrians (R9-14)
- K. No Hazardous Material (R14-3) (see Section 2B.62);
- L. NO THROUGH TRUCKS (R5-H2b);
- M. NO THROUGH TRAFFIC (R5-H2c);
- N. NO PEDESTRIANS / FARM MACHINERY / ANIMALS... (R5-H10d);
- O. NO PEDESTRIANS / BICYCLES / MOTORCYCLES... (R5-10e); and
- P. NO SNOWMOBILES / ALL PURPOSE VEHICLES (R5-10f).

Option:

- 05 Appropriate combinations or groupings of these legends into a single sign, such as NO PEDESTRIANS BICYCLES MOTOR-DRIVEN CYCLES (R5-10a), or NO PEDESTRIANS OR BICYCLES (R5-10b) may be used.

Guidance:

- 06 *If an exclusion is governed by vehicle weight, a Weight Limit sign (see Section 2B.59) should be used instead of a Selective Exclusion sign.*
- 07 *If used on a freeway or expressway ramp, the NO PEDESTRIANS OR BICYCLES (R5-10b) sign should be installed in a location where it is clearly visible to any pedestrian or bicyclist attempting to enter the limited access facility from a street intersecting the exit ramp.*
- 08 *The Selective Exclusion sign should be placed on the right-hand side of the roadway at an appropriate distance from the intersection so as to be clearly visible to all road users turning into the roadway that has the exclusion. The NO PEDESTRIANS (R5-10c) or No Pedestrian Crossing (R9-3) sign (see Section 2B.51) should be installed so as to be clearly visible to pedestrians who are at a location where an alternative route is available.*

Option:

- 09 The NO PEDESTRIANS (R5-10c) or No Pedestrian Crossing (R9-3) sign may also be used at underpasses or elsewhere where pedestrian facilities are not provided.
- 10 The NO TRUCKS (R5-2a) word message sign may be used as an alternate to the No Trucks (R5-2) symbol sign.
- 11 The AUTHORIZED VEHICLES ONLY (R5-11) sign may be used at median openings and other locations to prohibit vehicles from using the median opening or facility unless they have special permission (such as law enforcement vehicles or emergency vehicles) or are performing official business (such as highway agency vehicles).

Section 2B.40 ONE WAY Signs (R6-1, R6-2)

Standard:

- 01 **Except as provided in Paragraph 6, the ONE WAY (R6-1 or R6-2) sign (see Figure 2B-13) shall be used to indicate streets or roadways upon which vehicular traffic is allowed to travel in one direction only.**
- 02 **ONE WAY signs shall be placed parallel to the one-way street at all alleys and roadways that intersect one-way roadways as shown in Figure 2B-14.**
- 03 **At an intersection with a divided highway that has a median width at the intersection itself of 30 feet or more, ONE WAY signs shall be placed, visible to each crossroad approach, on the near right and far left corners of each intersection with the directional roadways (see Figure 2B-15).**
- 04 **At an intersection with a divided highway that has a median width at the intersection itself of less than 30 feet, Keep Right (R4-7) signs and/or ONE WAY signs shall be installed (see Figures 2B-16 and 2B-17). If Keep Right signs are installed, they shall be placed as close as practical to the approach ends of the medians and shall be visible to traffic on the divided highway and each crossroad approach. If ONE WAY signs are installed, they shall be placed on the near right and far left corners of the intersection and shall be visible to each crossroad approach.**
- 05 At an intersection with a divided highway that has a median width at the intersection itself of less than 30 feet, ONE WAY signs may also be placed on the far right corner of the intersection as shown in Figures 2B-16 and 2B-17.

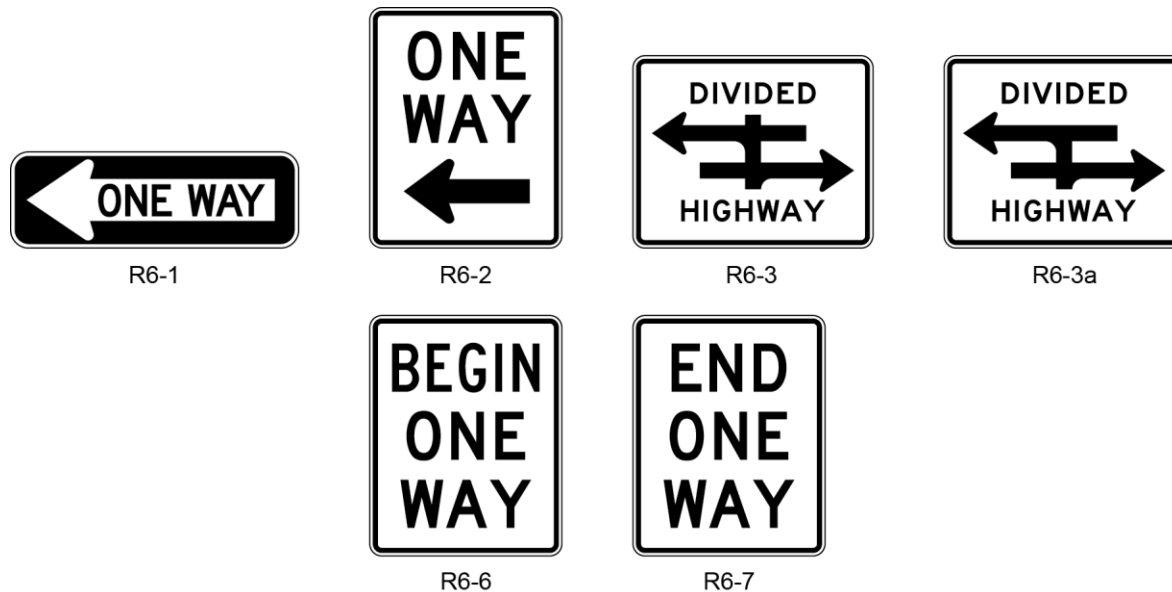
Figure 2B-13. ONE WAY and Divided Highway Crossing Signs

06 ONE WAY signs may be omitted on the one-way roadways of divided highways, where the design of interchanges indicates the direction of traffic on the separate roadways.

Standard:

07 **If used at unsignalized intersections with one-way streets, ONE WAY signs shall be placed on the near right and the far left corners of the intersection facing traffic entering or crossing the one-way street (see Figure 2B-14).**

08 **If used at signalized intersections with one-way streets, ONE WAY signs shall be placed near the appropriate signal faces, on the poles holding the traffic signals, on the mast arm or span wire holding the signals, or at the locations specified for unsignalized intersections.**

09 **At unsignalized T-intersections where the roadway at the top of the T-intersection is a one-way roadway, ONE WAY signs shall be placed on the near right and the far side of the intersection facing traffic on the stem approach (see Figure 2B-14).**

10 **At signalized T-intersections where the roadway at the top of the T-intersection is a one-way roadway, ONE WAY signs shall be placed near the appropriate signal faces, on the poles holding the traffic signals, on the mast arm or span wire holding the signals, or at the locations specified for unsignalized intersections.**

Option:

11 Where the central island of a roundabout allows for the installation of signs, ONE WAY signs may be used instead of or in addition to Roundabout Directional Arrow (R6-4 series) signs (see Section 2B.43) to direct traffic counter-clockwise around the central island.

Guidance:

12 *Where used on the central island of a roundabout, the mounting height of a ONE WAY sign should be at least 4 feet, measured vertically from the bottom of the sign to the elevation of the near edge of the traveled way.*

Support:

13 Using ONE WAY signs on the central island of a roundabout might result in some drivers incorrectly concluding that the cross street is a one-way street. Using Roundabout Directional Arrow signs might reduce this confusion.

Figure 2B-14. Locations of ONE WAY Signs

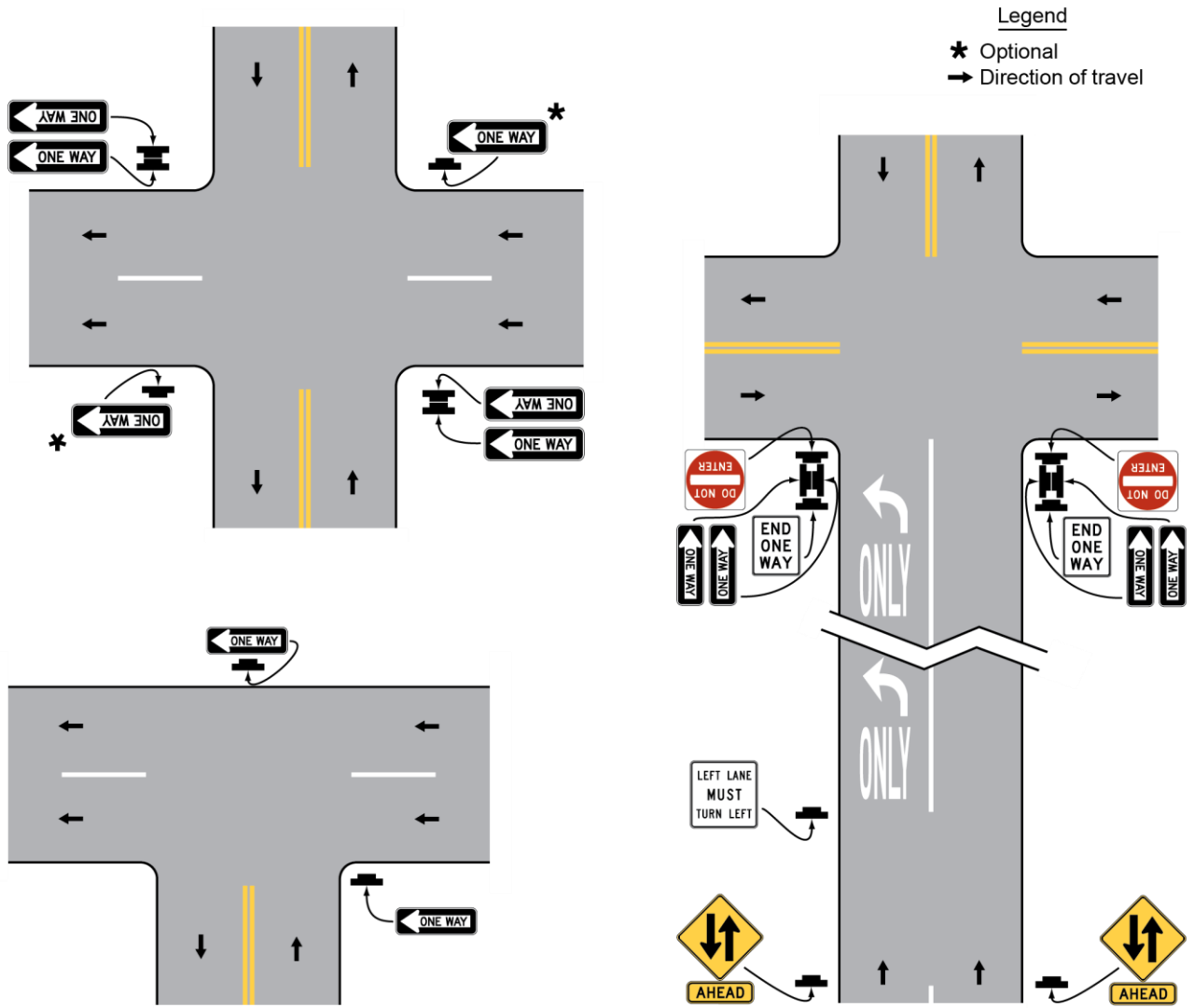

Option:

- 14 The BEGIN ONE WAY (R6-6) sign (see Figure 2B-13) may be used to notify road users of the beginning point of a one direction of travel restriction on the street or roadway. The END ONE WAY (R6-7) sign (see Figure 2B-13) may be used to notify road users of the ending point of a one direction of travel restriction on the street or roadway.

Section 2B.41 Wrong-Way Traffic Control at Interchange Ramps

Standard:

- 01 At interchange exit ramp terminals where the ramp intersects a crossroad in such a manner that wrong-way entry could inadvertently be made, the following signs shall be used (see Figure 2B-18):
 - A. At least one ONE WAY sign for each direction of travel on the crossroad shall be placed where the exit ramp intersects the crossroad.
 - B. At least one DO NOT ENTER sign shall be conspicuously placed near the downstream end of the exit ramp in positions appropriate for full view of a road user starting to enter wrongly from the crossroad.
 - C. At least one WRONG WAY sign shall be placed on the exit ramp facing a road user traveling in the wrong direction.

Figure 2B-15. ONE WAY Signing for Divided Highways with Median Widths of 30 Feet or Wider

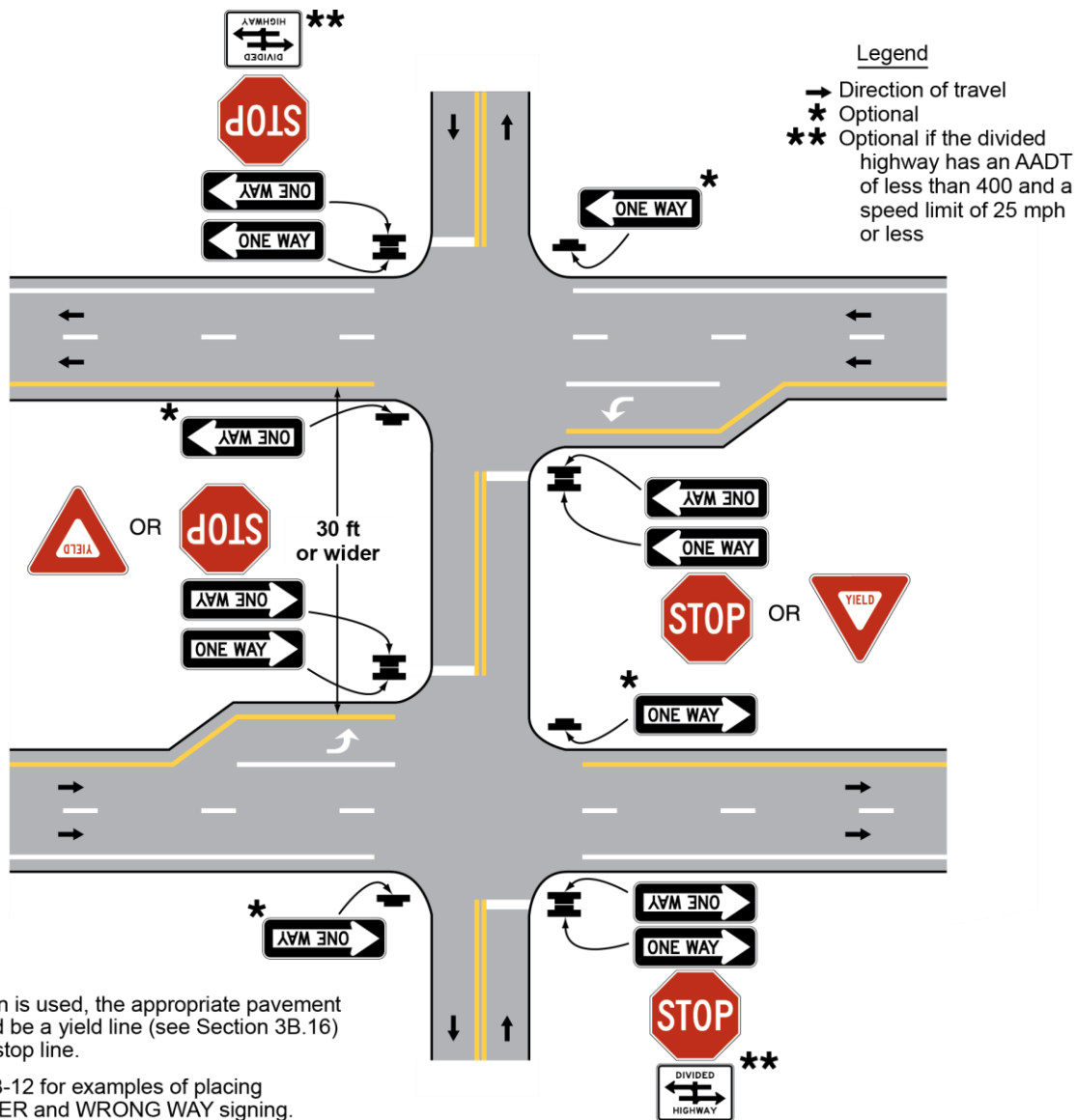

Guidance:

- 02 In addition, the following pavement markings should be used (see Figure 2B-18):
 - A. On two-lane paved crossroads at interchanges, double solid yellow lines should be used as a center line for an adequate distance on both sides approaching the ramp intersections.
 - B. Where crossroad channelization or ramp geometrics do not make wrong-way movements difficult, a lane-use arrow should be placed in each lane of an exit ramp near the crossroad terminal where it will be clearly visible to a potential wrong-way road user.

Option:

- 03 The following traffic control devices may be used to supplement the signs and pavement markings described in Paragraphs 1 and 2:
 - A. Additional ONE WAY signs may be placed, especially on two-lane rural crossroads, appropriately in advance of the ramp intersection to supplement the required ONE WAY sign(s).
 - B. Additional WRONG WAY signs may be used.

Figure 2B-16. ONE WAY Signing for Divided Highways with Median Widths Narrower Than 30 Feet

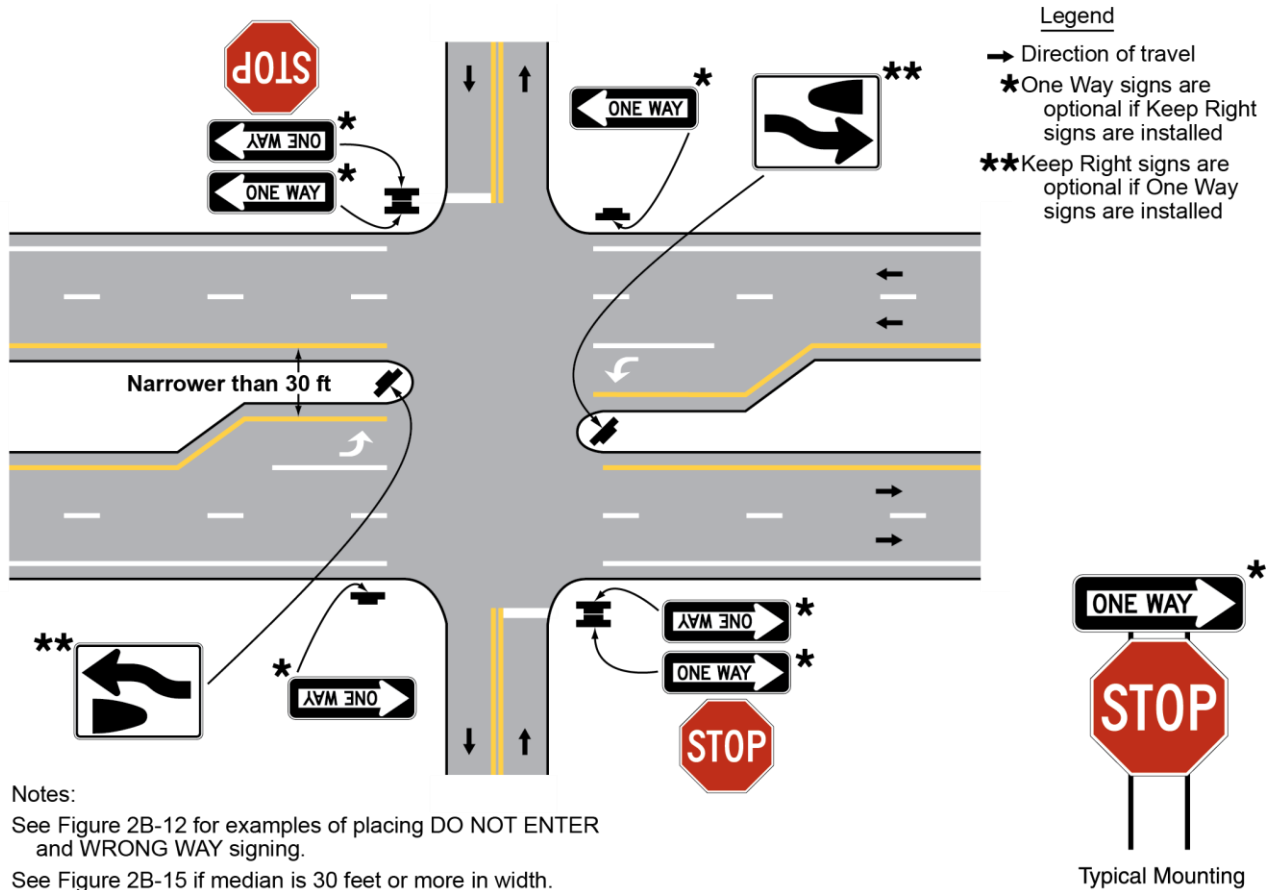

- C. Slender, elongated wrong-way arrow pavement markings (see Figure 3B-24) intended primarily to warn wrong-way road users that they are traveling in the wrong direction may be placed upstream from the ramp terminus (see Figure 2B-18) to indicate the correct direction of traffic flow. Wrong-way arrow pavement markings may also be placed on the exit ramp at appropriate locations near the crossroad junction to indicate wrong-way movement. The wrong-way arrow markings may consist of pavement markings or bidirectional red-and-white raised pavement markers or other units that show red to wrong-way road users and white to other road users (see Figure 3B-24).
- D. Lane-use arrow pavement markings may be placed on the exit ramp and crossroad near their intersection to indicate the permissive direction of flow.
- E. Freeway entrance signs (see Section 2D.46) may be used.

Guidance:

- 04 On interchange entrance ramps where the ramp merges with the through roadway and the design of the interchange does not clearly make evident the direction of traffic on the separate roadways or ramps, a ONE WAY sign visible to traffic on the entrance ramp and through roadway should be placed on each side of the through roadway near the entrance ramp merging point as illustrated in Figure 2B-19.

Option:

- 05 At locations where engineering judgment determines that a special need exists, other standard warning or prohibitive methods and devices may be used as a deterrent to the wrong-way movement.
- 06 Where there are no parked cars, pedestrian activity or other obstructions such as snow or vegetation, and if an engineering study indicates that a lower mounting height would address wrong-way movements on freeway or expressway exit ramps, a DO NOT ENTER sign(s) and/or a WRONG WAY sign(s) that is located along the exit ramp facing a road user who is traveling in the wrong direction may be installed at a

Figure 2B-17. ONE WAY Signing for Divided Highways with Medians Narrower Than 30 Feet and Separated Left-Turn Lanes

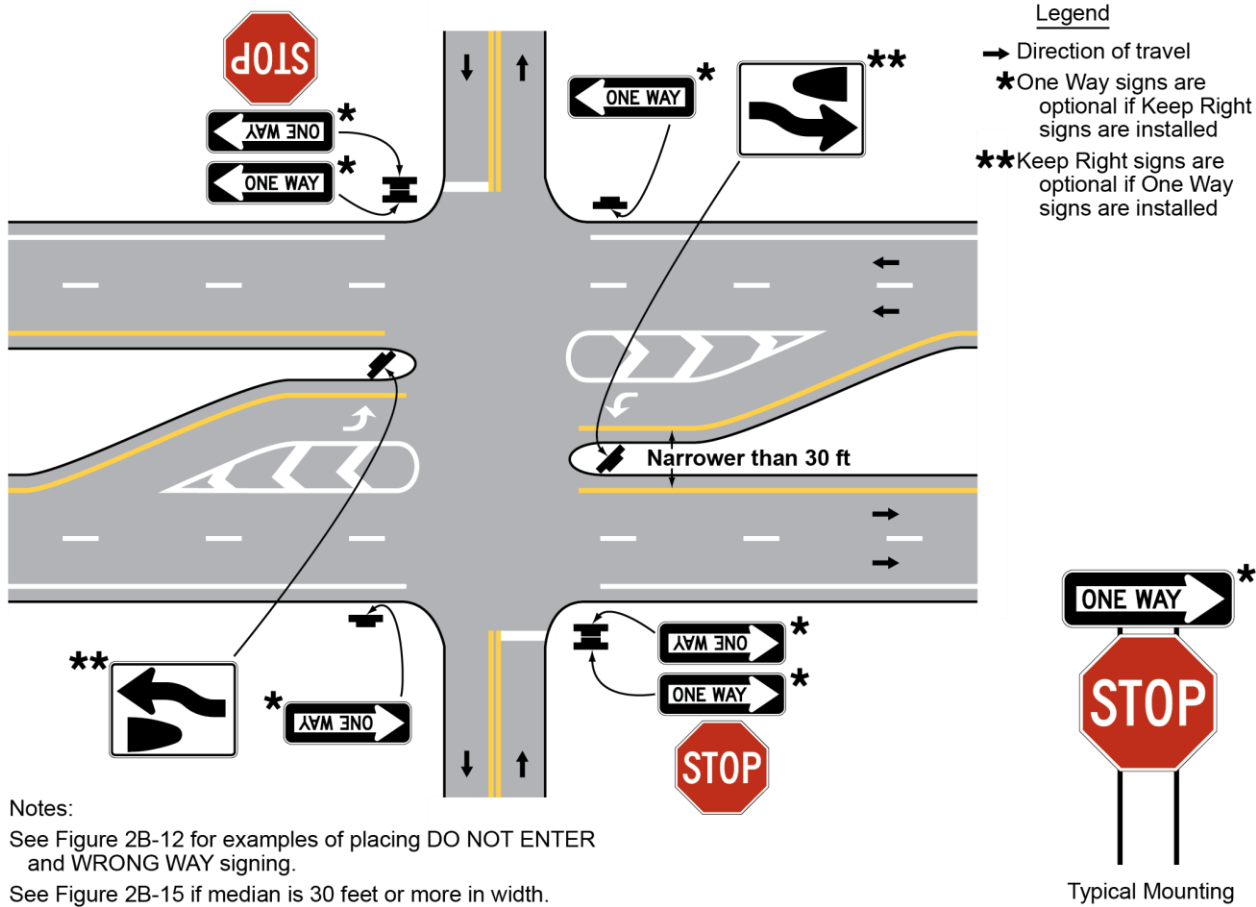

minimum mounting height of 3 feet, measured vertically from the bottom of the sign to the elevation of the near edge of the pavement.

Support:

07 Section 2B.42 contains further information on signing to avoid wrong-way movements at at-grade intersections on expressways.

Section 2B.42 Divided Highway Crossing Signs (R6-3, R6-3a)

Standard:

01 **On unsignalized minor-street approaches from which both left turns and right turns are permitted onto a divided highway that has a median width at the intersection itself of 30 feet or more, except as provided in Paragraph 2, a Divided Highway Crossing (R6-3 or R6-3a) sign (see Figure 2B-13) shall be used to advise road users that they are approaching an intersection with a divided highway (see Figure 2B-15).**

Option:

02 If the divided highway that has a median width at the intersection itself of 30 feet or more has a traffic volume of less than 400 AADT and a speed limit of 25 mph or less, the Divided Highway Crossing signs facing the unsignalized minor-street approaches may be omitted.

03 A Divided Highway Crossing sign may be used on signalized minor-street approaches from which both left turns and right turns are permitted onto a divided highway to advise road users that they are approaching an intersection with a divided highway.

Figure 2B.18. Example of Application of Regulatory Signing and Pavement Markings at an Exit Ramp Termination to Deter Wrong-Way Entry

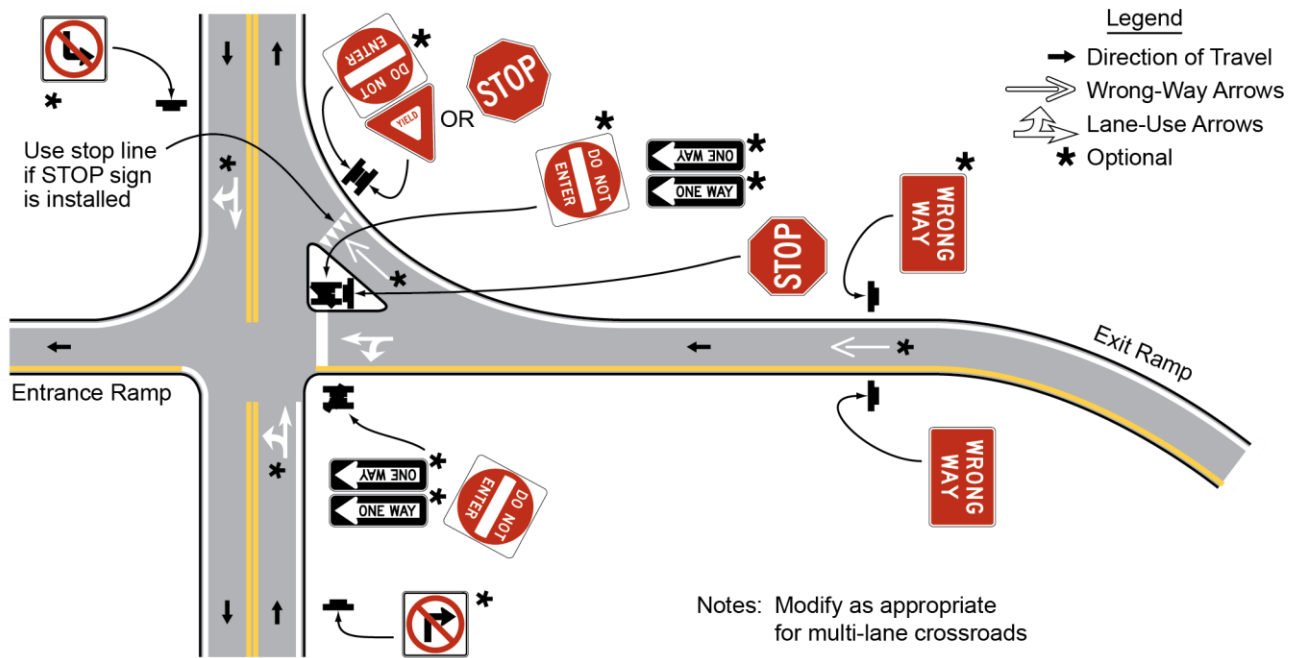
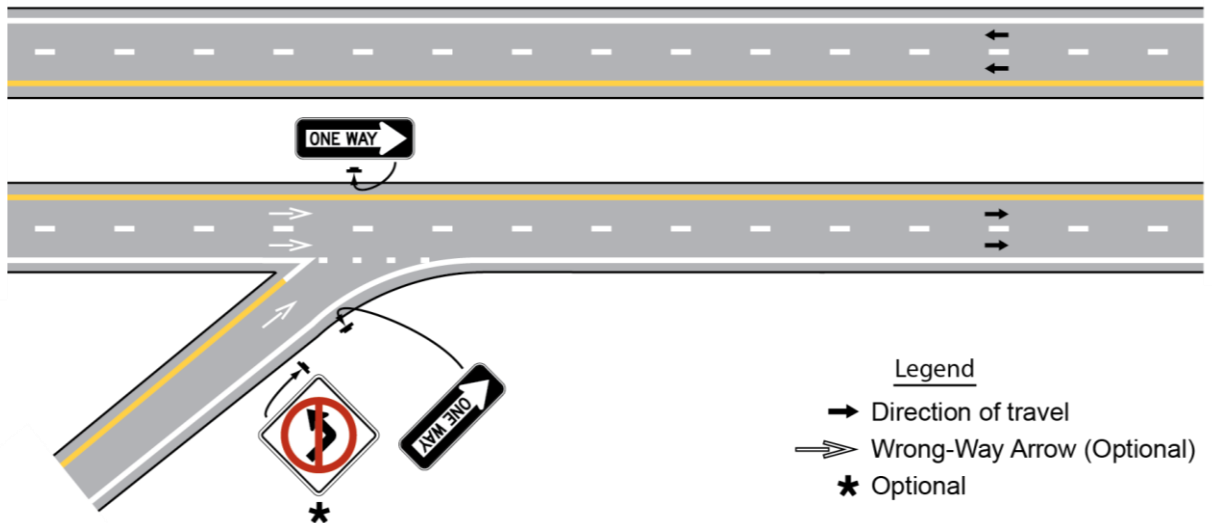

Figure 2B-19. Example of Application of Regulatory Signing and Pavement Markings at an Entrance Ramp Terminal Where the Design Does Not Clearly Indicate the Direction of Flow



Standard:

04 **If a Divided Highway Crossing sign is used at a four-legged intersection, the R6-3 sign shall be used. If used at a T-intersection, the R6-3a sign shall be used.**

05 **The Divided Highway Crossing sign shall be located on the near right corner of the intersection, mounted beneath a STOP or YIELD sign or on a separate support.**

Option:

06 An additional Divided Highway Crossing sign may be installed on the left-hand side of the approach to supplement the Divided Highway Crossing sign on the near right corner of the intersection.

Section 2B.43 Roundabout Directional Arrow Signs (R6-4, R6-4a, R6-4b)**Guidance:**

01 *Where the central island of a roundabout allows for the installation of signs, Roundabout Directional Arrow (R6-4 series) signs (see Figure 2B-20) should be used in the central island to direct traffic counter-clockwise around the central island, except as provided in Paragraph 11 in Section 2B.40.*

Standard:

02 **The R6-4 sign shall be a horizontal rectangle with two black chevron symbols pointing to the right on a white background. The R6-4a sign shall be a horizontal rectangle with three black chevron symbols pointing to the right on a white background. The R6-4b sign shall be a horizontal rectangle with four black chevron symbols pointing to the right on a white background. No border shall be used on the Roundabout Directional Arrow signs.**

03 **Roundabout Directional Arrow signs shall be used only at roundabouts and other circular intersections.**

Guidance:

04 *When used on the central island of a roundabout, the mounting height of a Roundabout Directional Arrow sign should be at least 4 feet, measured vertically from the bottom of the sign to the elevation of the near edge of the traveled way.*

Option:

05 More than one Roundabout Directional Arrow sign may be used facing high-speed approaches, facing approaches with limited visibility, or in other circumstances as determined by engineering judgment where increased sign visibility would be appropriate.

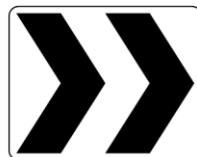
Figure 2B.20. Roundabout Signs and Plaques

R6-4



R6-4a



R6-4b



R6-5P

Figure 2B.21. Example of Regulatory and Warning Signs for a Mini-Roundabout

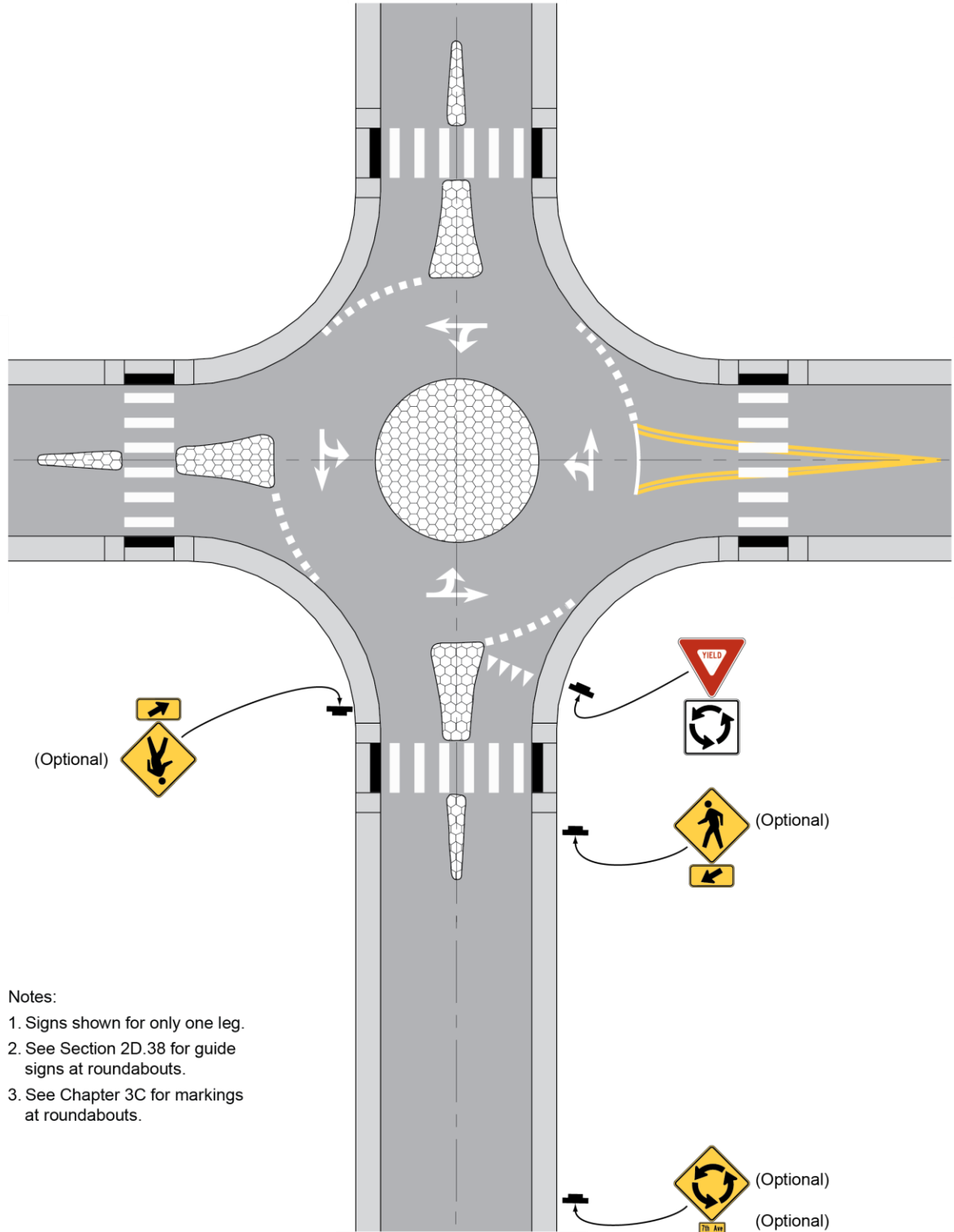
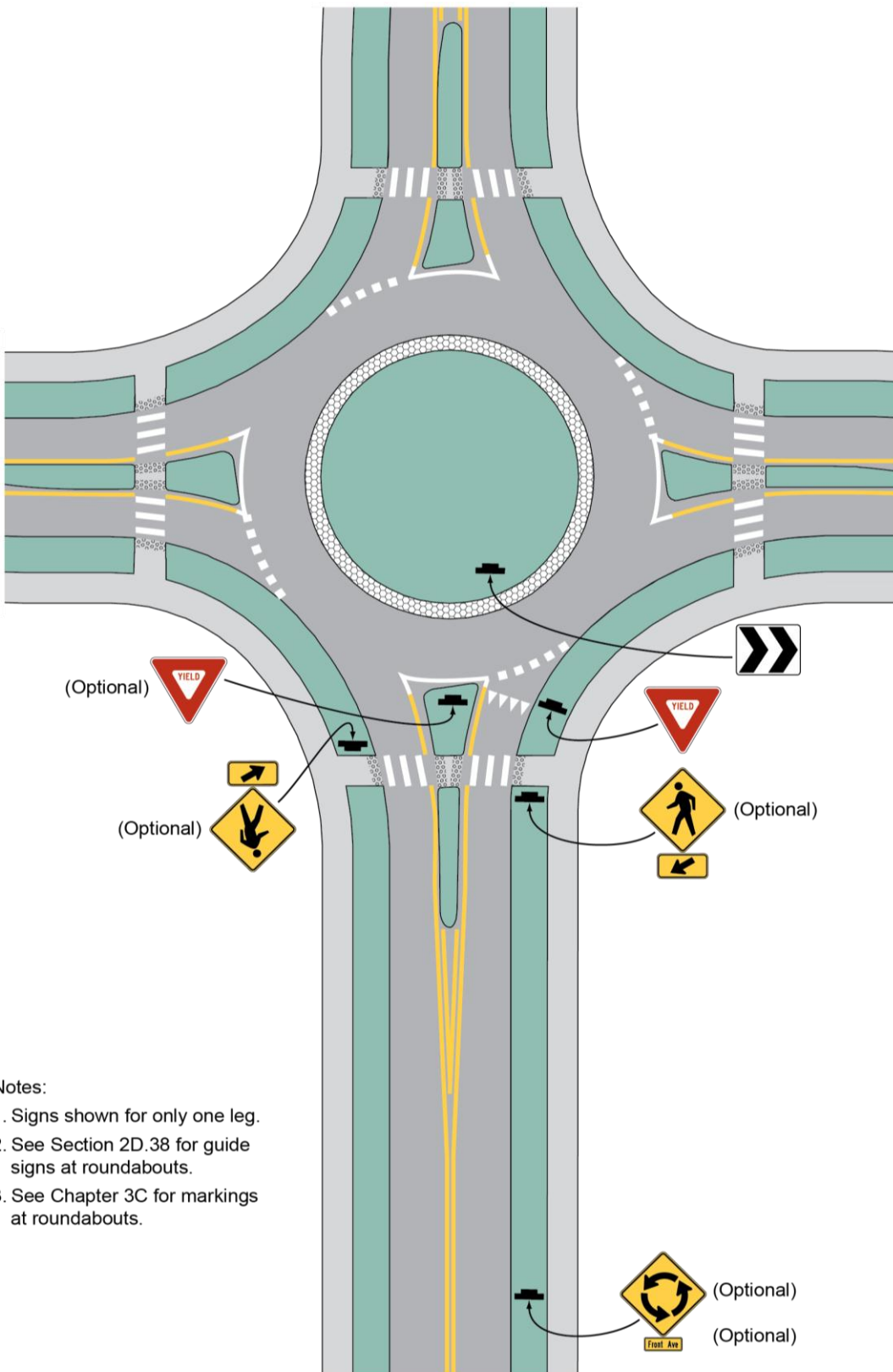

Figure 2B.22. Example of Regulatory and Warning Signs for a One-Lane Roundabout



Notes:

- 1. Signs shown for only one leg.
- 2. See Section 2D.38 for guide signs at roundabouts.
- 3. See Chapter 3C for markings at roundabouts.

Figure 2B.23. Examples of Regulatory and Warning Signs for a Two-Lane Roundabout with Consecutive Double Lefts

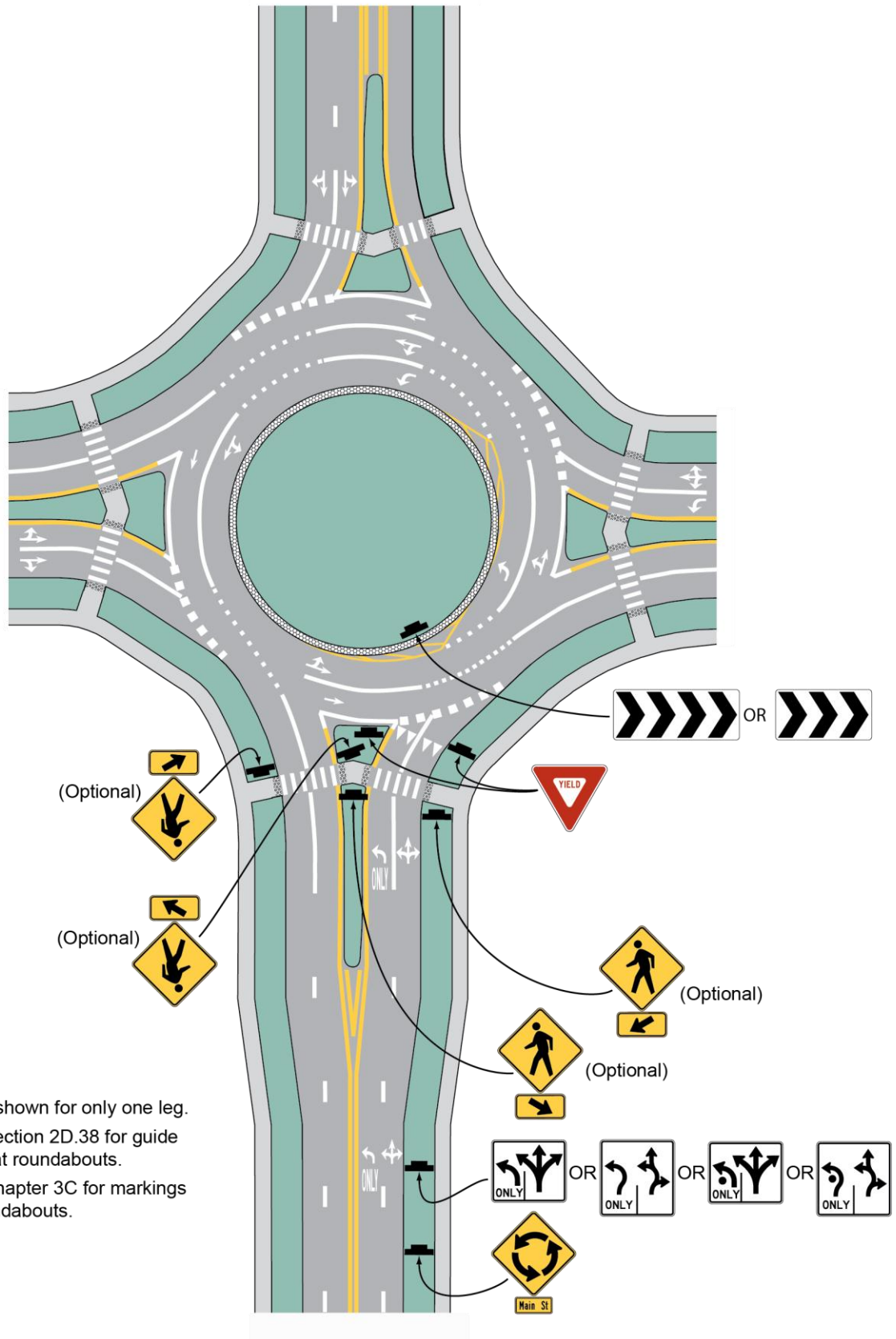

Notes:

- 1. Signs shown for only one leg.
- 2. See Section 2D.38 for guide signs at roundabouts.
- 3. See Chapter 3C for markings at roundabouts.

Section 2B.44 Roundabout Circulation Plaque (R6-5P)*Guidance:*

- 01 Where the central island of a roundabout does not provide a reasonable place to install a sign, Roundabout Circulation (R6-5P) plaques (see Figure 2B-20) should be placed below the YIELD signs on each approach.

Option:

- 02 At roundabouts where Roundabout Directional Arrow signs and/or ONE WAY signs have been installed in the central island, Roundabout Circulation plaques may be placed below the YIELD signs on approaches to roundabouts to supplement the central island signs.
- 03 The Roundabout Circulation plaque may be used at any type of circular intersection.

Section 2B.45 Examples of Roundabout Signing*Support:*

- 01 Figures 2B-21 through 2B-23 illustrate examples of regulatory and warning signing for roundabouts of various configurations.
- 02 Section 2D.38 contains information regarding guide signing at roundabouts and Chapter 3C contains information regarding pavement markings at roundabouts.

Section 2B.46 Parking, Standing, and Stopping Signs (R7 and R8 Series)*Support:*

- 01 Signs governing the parking, stopping, and standing of vehicles cover a wide variety of regulations, and only general guidance can be provided here. The word “standing” when used on the R7 and R8 series of signs refers to the practice of a driver keeping the vehicle in a stationary position while continuing to occupy the vehicle. Typical examples of parking, stopping, and standing signs and plaques (see Figures 2B-24 and 2B-25) are as follows:

1. NO PARKING ANY TIME (R7-1);
2. NO PARKING X:XX AM TO X:XX PM (R7-2, R7-2a);
3. NO PARKING EXCEPT SUNDAYS AND HOLIDAYS (R7-3);
4. NO STANDING ANY TIME (R7-4);
5. XX HOUR PARKING X:XX AM – X:XX PM (R7-5);
6. NO PARKING LOADING ZONE (R7-6);
7. NO PARKING BUS STOP (R7-7, R7-107, R7-107a);
8. RESERVED PARKING for persons with disabilities (R7-8);
9. VAN ACCESSIBLE (R7-8P);
10. Pay Station (R7-20);
11. Pay Parking (R7-21, R7-21a, R7-22);
12. Parking Permitted X:XX AM TO X:XX PM (R7-23);
13. Parking Permitted XX HOUR(S) XX AM – XX PM (R7-23a);
14. XX HR PARKING X:XX AM TO X:XX PM (R7-108);
15. NO PARKING ANYTIME/XX HOUR PARKING X:XX AM – X:XX PM (R7-200, R7-200a);
16. TOW-AWAY ZONE (R7-201P, R7-201aP);
17. THIS SIDE OF SIGN (R7-202P);
18. EMERGENCY SNOW ROUTE NO PARKING IF OVER XX INCHES (R7-203);
19. NO PARKING ON PAVEMENT (R8-1);
20. NO PARKING EXCEPT ON SHOULDER (R8-2);
21. No Parking (R8-3, R8-3a);
22. EXCEPT SUNDAYS AND HOLIDAYS (R8-3bP);
23. ON PAVEMENT (R8-3cP);
24. ON BRIDGE (R8-3dP);
25. ON TRACKS (R8-3eP);
26. EXCEPT ON SHOULDER (R8-3fP);
27. LOADING ZONE (R8-3gP);

- 28. X:XX AM TO X:XX PM (R8-3hP)29. EMERGENCY PARKING ONLY (R8-4);
- 30. NO STOPPING ON PAVEMENT (R8-5);
- 31. NO STOPPING EXCEPT ON SHOULDER (R8-6); and
- 32. EMERGENCY STOPPING ONLY (R8-7).

02 Section 4511.68 of the Ohio Revised Code (ORC) (see Appendix B2) addresses parking prohibitions.

Figure 2B-24. Parking and Standing Signs and Plaques (R7 Series) (Sheet 1 of 2)

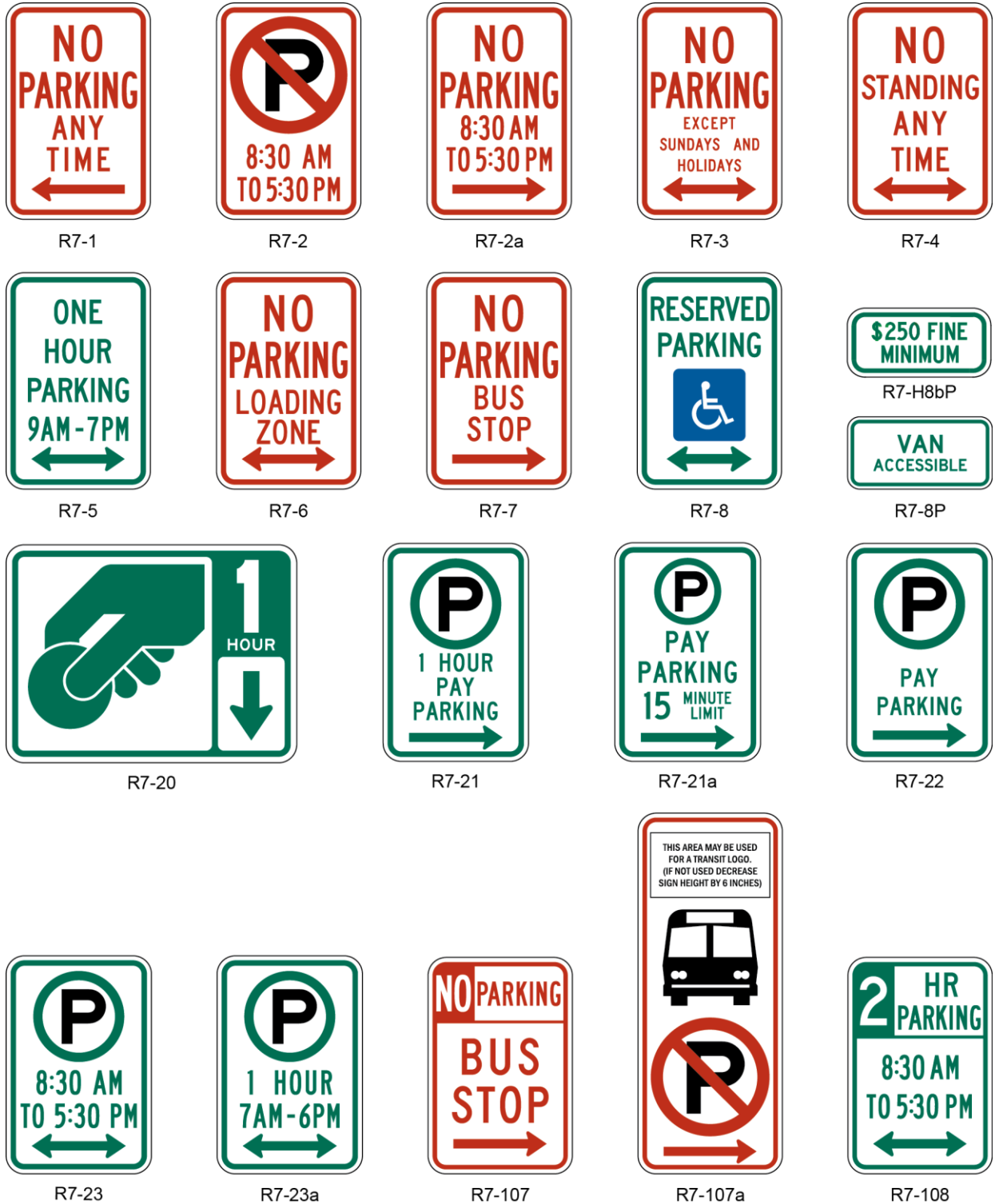

Standard:

03 In accordance with ORC Section 4511.69, the RESERVED PARKING for persons with disabilities (R7-8) sign shall be supplemented with the \$250 FINE MINIMUM (R7-H8b) sign. The R7-H8b shall be mounted directly below the R7-8 or next to it.

Section 2B.47 Design of Parking, Standing, and Stopping Signs

Support:

01 Discussions of parking signs and parking regulations in this Section apply not only to parking, but also to standing and stopping.

Standard:

02 The legend on parking signs shall state applicable regulations. Parking signs (see Figures 2B-24 and 2B-25) shall comply with the standards of shape, color, and location.

03 Where parking is prohibited at all times or at specific times, the basic design for parking signs shall have a red legend and border on a white background (Parking Prohibition signs), except that the R8-4 and R8-7 signs and the alternate design for the R7-201P plaque shall have a black legend and border on a white background, and the R8-3 sign shall have a black legend and border and a red circle and slash on a white background.

04 Where only limited-time parking or parking in a particular manner is permitted, the signs shall have a green legend and border on a white background (Permissive Parking signs).

Guidance:

05 Parking signs should display the following information from top to bottom of the sign, in the order listed:

- A. The restriction or prohibition;
- B. The times of the day that it is applicable, if not at all hours; and
- C. The days of the week that it is applicable, if not every day.

06 If the parking restriction applies to a limited area or zone, the limits of the restriction should be shown by arrows or supplemental plaques. If arrows are used and if the sign is at the end of a parking zone, there should be a single-headed arrow pointing in the direction that the regulation is in effect. If the sign is at an intermediate point in a zone, there should be a double-headed arrow pointing both ways. When a single sign is used at the transition point between two parking zones, it should display a right and left arrow pointing in the direction that the respective restrictions apply.

Figure 2B-24. Parking and Standing Signs and Plaques (R7 Series) (Sheet 2 of 2)

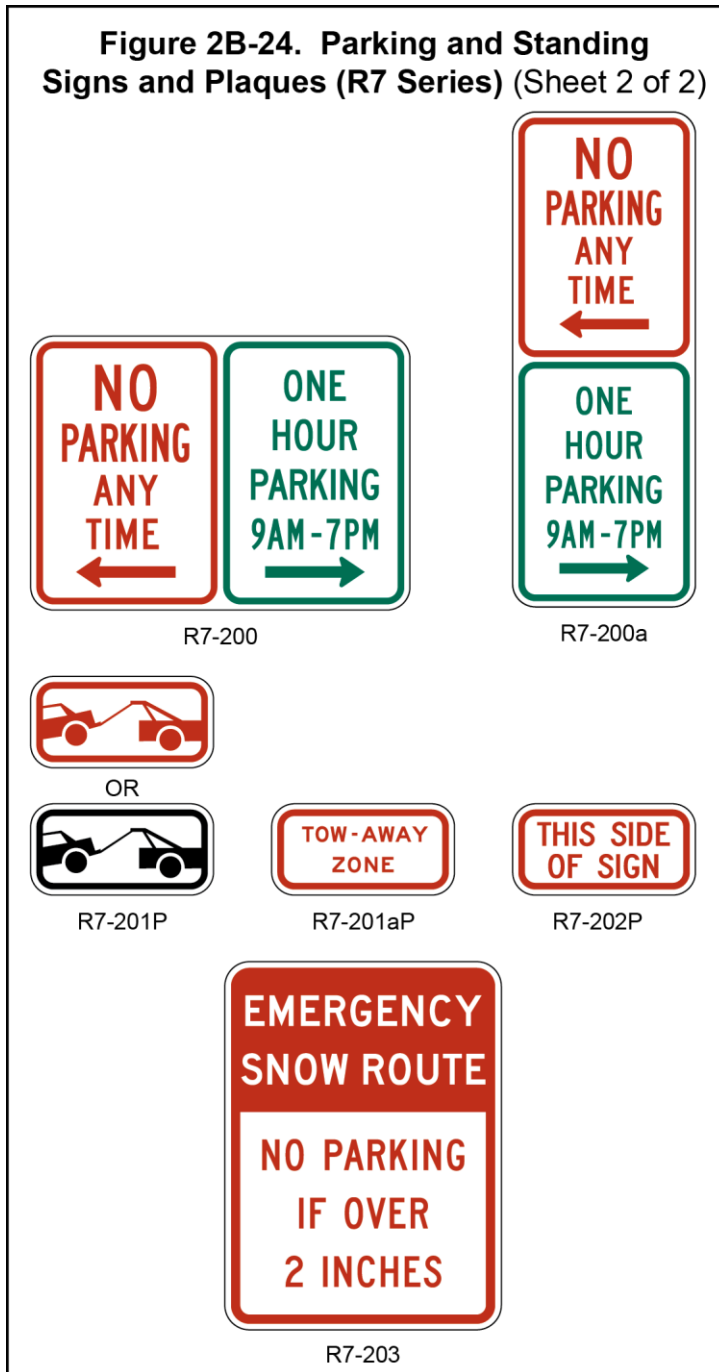

Figure 2B-25. Parking and Stopping Signs and Plaques (R8 Series)



07 *Where special parking restrictions are imposed during heavy snowfall, Emergency Snow Route (R7-203) signs (see Figure 2B-24) should be installed. The legend will vary according to the regulations, but the signs should be vertical rectangles, having a white background with the upper part of the plate a red background.*

Standard:

08 **Where parking spaces that are reserved for persons with disabilities are designated to accommodate wheelchair vans, a VAN ACCESSIBLE (R7-8P) plaque shall be mounted below the R7-8 sign. The R7-8 sign (see Figure 2B-24) shall have a green legend and border and a white wheelchair symbol on a blue square, all on a white background. The R7-8P plaque (see Figure 2B-24) shall have a green legend and border on a white background.**

Option:

09 To minimize the number of parking signs, blanket regulations that apply to a given district may, if legal, be posted at district boundary lines.

10 As an alternate to the use of arrows to show designated restriction zones, word messages such as BEGIN, END, HERE TO CORNER, HERE TO ALLEY, THIS SIDE OF SIGN, or BETWEEN SIGNS may be used.

11 Where parking is prohibited during certain hours and time-limited parking or parking in a particular manner is permitted during certain other time periods, the red Parking Prohibition and green Permissive Parking signs may be designed as follows:

- A. Two 12 x 18-inch parking signs may be used with the red Parking Prohibition sign installed above or to the left of the green Permissive Parking sign; or
- B. The red Parking Prohibition sign and the green Permissive Parking sign may be combined (see Figure 2B-24) to form an R7-200 sign on a single 24 x 18-inch sign, or an R7-200a sign on a single 12 x 30-inch sign.

12 At the transition point between two parking zones, a single sign or two signs mounted side by side may be used.

13 The words NO PARKING may be used as an alternative to the No Parking symbol. The supplemental educational plaque, NO PARKING, with a red legend and border on a white background, may be used above signs incorporating the No Parking symbol.

14 Alternate designs for the R7-107 sign may be developed such as the R7-107a sign (see Figure 2B-24). Alternate designs may include, on a single sign, a transit logo, an approved bus symbol, a parking prohibition, the words BUS STOP, and an arrow. The preferred bus symbol color is black, but other dark colors may be used. Additionally, the transit logo may be displayed on the bus face in the appropriate colors instead of placing the logo separately. The reverse side of the sign may contain bus routing information.

15 To make the parking regulations more effective and to improve public relations by giving a definite warning, a TOW-AWAY ZONE (R7-201aP) plaque (see Figure 2B-24) may be appended to, or incorporated in, any parking prohibition sign. The Tow-Away Zone (R7-201P) symbol plaque may be used instead of the R7-201aP word message plaque. The R7-201P plaque may have either a black or red legend and border on a white background.

Guidance:

16 *If a fee is charged for parking and a midblock pay station is used instead of individual parking meters for each parking space, pay parking signs should be used. Pay Parking (R7-21, R7-21a, R7-22) signs (see Figure 2B-24) should be used to define the area where the pay station parking applies. Pay Station (R7-20) signs (see Figure 2B-24) should be used at the pay station or to direct road users to the pay station.*

Standard:

17 **If the pay parking is subject to a maximum time limit, the appropriate time limit (number of hours or minutes) shall be displayed on the Pay Parking (R7-21 or R7-21a) and Pay Station (R7-20) signs.**

Option:

18 In rural areas, the legends NO PARKING ON PAVEMENT (R8-1) or NO STOPPING ON PAVEMENT (R8-5) are generally suitable and may be used (see Figure 2B-25). If a roadway has paved shoulders, the NO PARKING EXCEPT ON SHOULDER sign (R8-2) or the NO STOPPING EXCEPT ON SHOULDER sign (R8-6) may be used as these signs would be less likely to cause confusion. The R8-3 symbol sign or the word message NO PARKING (R8-3a) sign may be used to prohibit any parking along a given highway. Word message supplemental plaques may be mounted below the R8-3 or R8-3a sign. These word message supplemental plaques may include legends such as EXCEPT SUNDAYS AND HOLIDAYS (R8-3bP), ON PAVEMENT (R8-3cP), ON BRIDGE (R8-3dP), ON TRACKS (R8-3eP), EXCEPT ON SHOULDERS (R8-3fP), LOADING ZONE (with arrow) (R8-3gP), and X:XX AM TO X:XX PM (with arrow) (R8-3hP).

19 Colors that are in compliance with the provisions of Section 2A.10 may be used for color coding of parking time limits.

Guidance:

20 *If colors are used for color coding of parking time limits, the colors green, red, and black should be the only colors that are used.*

Section 2B.48 Placement of Parking, Stopping, and Standing Signs

Guidance:

01 *When signs with arrows are used to indicate the extent of the restricted zones, the signs should be set at an angle of not less than 30 degrees or more than 45 degrees with the line of traffic flow in order to be visible to approaching traffic.*

02 *Spacing of signs should be based on legibility and sign orientation.*

03 *If the zone is unusually long, signs displaying a double arrow should be used at intermediate points within the zone.*

Standard:

04 **If the signs are mounted at an angle of 90 degrees to the curb line, two signs shall be mounted back to back at the transition point between two parking zones, each with an appended THIS SIDE OF SIGN (R7-202P) supplemental plaque.**

- 05 *If the signs are mounted at an angle of 90 degrees to the curb line, signs without any arrows or appended plaques should be used at intermediate points within a parking zone, facing in the direction of approaching traffic. Otherwise, the standards of placement should be the same as for signs using directional arrows.*

Section 2B.49 Emergency Restriction Signs (R8-4, R8-7, R8-8)

Option:

- 01 The EMERGENCY PARKING ONLY (R8-4) sign (see Figure 2B-25) or the EMERGENCY STOPPING ONLY (R8-7) sign (see Figure 2B-25) may be used to discourage or prohibit shoulder parking, particularly where scenic or other attractions create a tendency for road users to stop temporarily.
- 02 The DO NOT STOP ON TRACKS (R8-8) sign (see Figure 8B-1) may be used to discourage or prohibit parking or stopping on railroad or light rail transit tracks (see Section 8B.09).

Standard:

- 03 **Emergency Restriction signs shall be rectangular and shall have a red or black legend and border on a white background.**
- Support:
- 04 Section 4511.712 of the Ohio Revised Code (ORC) (see Appendix B2) addresses the obstruction of railroad grade crossings.

Section 2B.50 WALK ON LEFT FACING TRAFFIC and No Hitchhiking Signs (R9-1, R9-4, R9-4a)

Option:

- 01 The WALK ON LEFT FACING TRAFFIC (R9-1) sign (see Figure 2B-26) may be used on highways where no sidewalks are provided.

Standard:

- 02 **If used, the WALK ON LEFT FACING TRAFFIC sign shall be installed on the right-hand side of the road where pedestrians walk on the pavement or shoulder in the absence of pedestrian pathways or sidewalks.**

Option:

- 03 The No Hitchhiking (R9-4) sign (see Figure 2B-26) may be used to prohibit standing in or adjacent to the roadway for the purpose of soliciting a ride. The R9-4a word message sign (see Figure 2B-26) may be used as an alternate to the R9-4 symbol sign.

Section 2B.51 Pedestrian Crossing Signs (R9-2, R9-3)

Option:

- 01 Pedestrian Crossing signs (see Figure 2B-26) may be used to limit pedestrian crossing to specific locations.

Standard:

- 02 **If used, Pedestrian Crossing signs shall be installed to face pedestrian approaches.**

Option:

- 03 Where crosswalks are clearly defined, the CROSS ONLY AT CROSSWALKS (R9-2) sign may be used to prohibit pedestrians from crossing at locations away from crosswalks.
- 04 The No Pedestrian Crossing (R9-3) sign may be used to prohibit pedestrians from crossing a roadway at an undesirable location or in front of a school or other public building where a crossing is not designated.
- 05 The NO PEDESTRIAN CROSSING (R9-3a) word message sign may be used as an alternate to the R9-3 symbol sign. The USE CROSSWALK (R9-3bP) supplemental plaque, along with an arrow, may be installed below either sign to designate the direction of the crossing.

Support:

- 06 One of the most frequent uses of the Pedestrian Crossing signs is at signalized intersections that have three crossings that can be used and one leg that cannot be crossed.

Figure 2B-26. Pedestrian Signs and Plaques (Sheet 1 of 2)



R9-1



R9-2



R9-3



R9-3a



R9-3bP



R9-4



R9-4a



R10-1



R10-2



R10-3



R10-3a



R10-3b

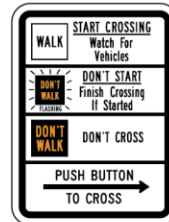

R10-3c



R10-3d



R10-3e

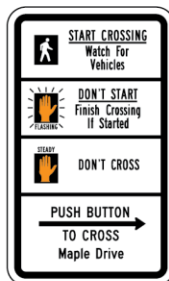

R10-3f

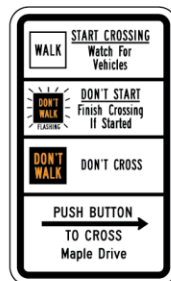

R10-3g

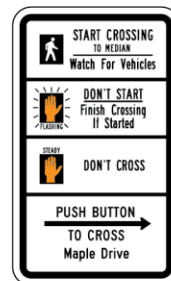

R10-3h

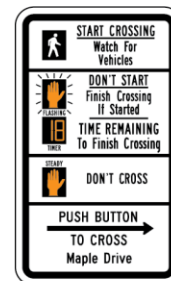

R10-3i

Figure 2B-26. Pedestrian Signs and Plaques (Sheet 2 of 2)

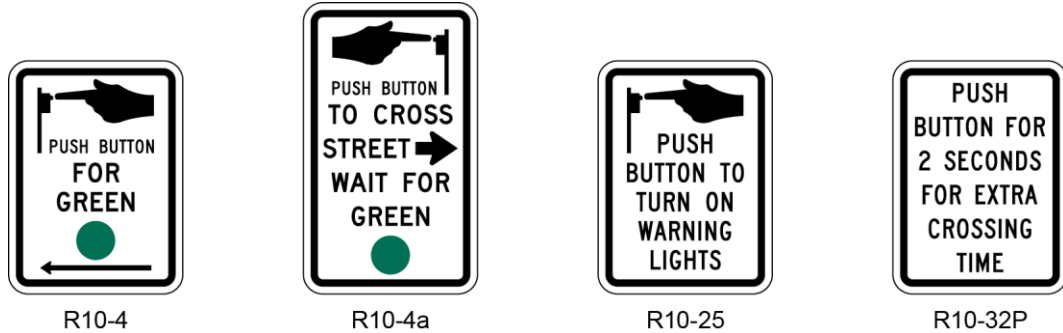

Guidance:

- 07 *The R9-3bP plaque should not be installed in combination with educational plaques.*

Section 2B.52 Traffic Signal Pedestrian and Bicycle Actuation Signs (R10-1 through R10-4, and R10-24 through R10-26)

Standard:

- 01 **Traffic Signal signs applicable to pedestrian actuation (see Figure 2B-26) or bicyclist actuation (see Figure 9B-2) shall be mounted immediately above or incorporated into the pushbutton detector units (see Section 4E.08).**

Support:

- 02 Traffic Signal signs applicable to pedestrians include:
 - A. CROSS ONLY ON GREEN (symbolic circular green) (R10-1);
 - B. CROSS ONLY ON (symbolic walk indication) SIGNAL (R10-2);
 - C. Push Button for Walk Signal (R10-3 series); and
 - D. Push Button for Green Signal (R10-4 series).

Option:

- 03 The following signs may be used as an alternate for the R10-3 and R10-4 signs:
 - A. Push Button to Cross Street Wait for Walk Signal (R10-3a); and
 - B. Push Button to Cross Street Wait for Green Signal (R10-4a).
- 04 The name of the street to be crossed may be substituted for the word STREET in the legends on the R10-3a and R10-4a signs.

Guidance:

- 05 *The finger in the pushbutton symbol on the R10-3, R10-3a, R10-4, and R10-4a signs should point in the same direction as the arrow on the sign.*

Option:

- 06 Where symbol-type pedestrian signal indications are used, an educational sign (R10-3b) may be used instead of the R10-3 sign to improve pedestrian understanding of pedestrian indications at signalized intersections. Where word-type pedestrian signal indications are being retained for the remainder of their useful service life, the legends WALK/DONT WALK may be substituted for the symbols on the educational sign R10-3b, thus creating educational sign R10-3c. The R10-3d educational sign may be used to inform pedestrians that the pedestrian clearance time is sufficient only for the pedestrian to cross to the median at locations where pedestrians cross in two stages using a median refuge island. The R10-3e educational sign may be used where countdown pedestrian signals have been provided. In order to assist the pedestrian in understanding which pushbutton to push, the R10-3f to R10-3i educational signs that provide the name of the street to be crossed may be used instead of the R10-3b to R10-3e educational signs.
- 07 The R10-24 or R10-26 sign (see Section 9B.11) may be used where a pushbutton detector has been installed exclusively to actuate a green phase for bicyclists.

08 The R10-25 sign (see Figure 2B-26) may be used where a pushbutton detector has been installed for pedestrians to activate In-Roadway Warning Lights (see Chapter 4N) or flashing beacons that have been added to the pedestrian warning signs.

Support:

09 Section 4E.08 contains information regarding the application of the R10-32P plaque.

Section 2B.53 Traffic Signal Signs (R10-5 through R10-30)

Option:

01 To supplement traffic signal control, Traffic Signal signs R10-5 through R10-30 may be used to regulate road users.

02 Traffic Signal signs (see Figure 2B-27) may be installed at certain locations to clarify signal control. Among the legends that may be used for this purpose are LEFT ON GREEN ARROW ONLY (R10-5), STOP HERE ON RED (R10-6 or R10-6a) for observance of stop lines, DO NOT BLOCK INTERSECTION (R10-7) for avoidance of traffic obstructions, USE LANE(S) WITH GREEN ARROW (R10-8) for obedience to lane-use control signals (see Chapter 4M), LEFT TURN YIELD ON GREEN (symbolic circular green) (R10-12), and LEFT TURN YIELD ON FLASHING RED ARROW AFTER STOP (R10-27).

Guidance:

03 *If used, the LEFT ON GREEN ARROW ONLY (R10-5) sign, the LEFT TURN YIELD ON GREEN (symbolic circular green) (R10-12) sign, or the LEFT TURN YIELD ON FLASHING RED ARROW AFTER STOP (R10-27) sign should be located adjacent to the left-turn signal face.*

Option:

04 If needed for additional emphasis, an additional LEFT TURN YIELD ON GREEN (symbolic circular green) (R10-12) sign with an AT SIGNAL (R10-31P) supplemental plaque (see Figure 2B-27) may be installed in advance of the intersection.

05 In situations where traffic control signals are coordinated for progressive timing, the Traffic Signal Speed (I1-1) sign may be used (see Section 2H.03).

Standard:

06 **The CROSSWALK STOP ON RED (symbolic circular red) (R10-23) sign (see Figure 2B-27) shall only be used in conjunction with pedestrian hybrid beacons (see Section 4F.02).**

07 **The EMERGENCY SIGNAL (R10-13) sign (see Figure 2B-27) shall be used in conjunction with emergency-vehicle traffic control signals (see Section 4G.02).**

08 **The EMERGENCY SIGNAL—STOP ON FLASHING RED (R10-14 or R10-14a) sign (see Figure 2B-27) shall be used in conjunction with emergency-vehicle hybrid beacons (see Section 4G.04).**

Option:

09 If needed for extra emphasis, a STOP HERE ON FLASHING RED (R10-14b) sign (see Section 4.) may be installed with an emergency-vehicle hybrid beacon (see Section 4G.04).

Standard:

10 **As noted in Section 4D.20, when a flashing yellow arrow indication is used a LEFT TURN YIELD ON FLASHING YELLOW ARROW (R10-H12c) sign shall be used with it for at least five years.**

Option:

11 In order to remind drivers who are making turns to yield to pedestrians, a Turning Vehicles Yield to Pedestrians (R10-15) sign (see Figure 2B-27) may be used.

12 A U-TURN YIELD TO RIGHT TURN (R10-16) sign (see Figure 2B-27) may be installed near the left-turn signal face if U-turns are allowed on a protected left-turn movement on an approach from which a right-turn GREEN ARROW signal indication is simultaneously being displayed to drivers making a right turn from the conflicting approach to their left (see Section 4D.05, Paragraph 4).

Figure 2B-27. Traffic Signal Signs and Plaques

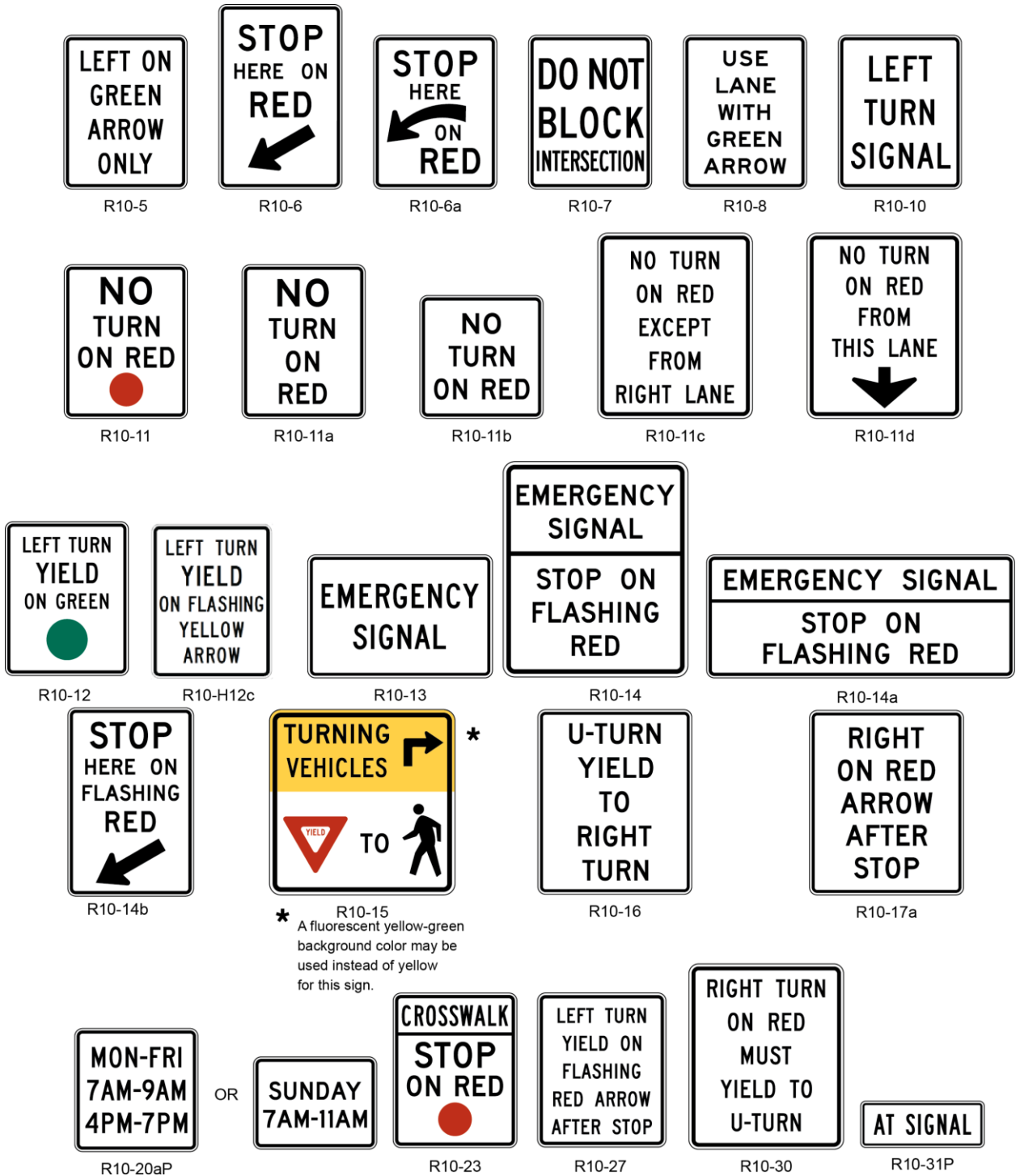

Section 2B.54 No Turn on Red Signs (R10-11 Series, R10-17a, and R10-30)**Standard:**

01 **Where a right turn on red (or a left turn on red from a one-way street to a one-way street) is to be prohibited, a symbolic NO TURN ON RED (symbolic circular red) (R10-11) sign (see Figure 2B-27) or a NO TURN ON RED (R10-11a, R10-11b) word message sign (see Figure 2B-27) shall be used.**

Guidance:

02 *If used, the No Turn on Red sign should be installed near the appropriate signal head.*

03 A No Turn on Red sign should be considered when an engineering study finds that one or more of the following conditions exists:

- A. *Inadequate sight distance to vehicles approaching from the left (or right, if applicable);*
- B. *Geometrics or operational characteristics of the intersection that might result in unexpected conflicts;*
- C. *An exclusive pedestrian phase;*
- D. *An unacceptable number of pedestrian conflicts with right-turn-on-red maneuvers, especially involving children, older pedestrians, or persons with disabilities;*
- E. *More than three right-turn-on-red accidents reported in a 12-month period for the particular approach; or*
- F. *The skew angle of the intersecting roadways creates difficulty for drivers to see traffic approaching from their left.*

Option:

04 A supplemental R10-20aP plaque (see Figure 2B-27) showing times of day (similar to the S4-1P plaque shown in Figure 7B-1) with a black legend and border on a white background may be mounted below a No Turn on Red sign to indicate that the restriction is in place only during certain times.

05 Alternatively, a blank-out sign may be used instead of a static NO TURN ON RED sign, to display either the NO TURN ON RED legend or the No Right Turn symbol or word message, as appropriate, only at certain times during the day or during one or more portion(s) of a particular cycle of the traffic signal.

06 On signalized approaches with more than one right-turn lane, a NO TURN ON RED EXCEPT FROM RIGHT LANE (R10-11c) sign (see Figure 2B-27) may be post-mounted at the intersection or a NO TURN ON RED FROM THIS LANE (with down arrow) (R10-11d) sign (see Figure 2B-27) may be mounted directly over the center of the lane from which turns on red are prohibited.

Guidance:

07 *Where turns on red are permitted and the signal indication is a steady RED ARROW, the RIGHT (LEFT) ON RED ARROW AFTER STOP (R10-17a) sign (see Figure 2B-27) should be installed adjacent to the RED ARROW signal indication.*

Option:

08 A RIGHT TURN ON RED MUST YIELD TO U-TURN (R10-30) sign (see Figure 2B-27) may be installed to remind road users that they must yield to conflicting U-turn traffic on the street or highway onto which they are turning right on a red signal after stopping.

Section 2B.55 Photo Enforced Signs and Plaques (R10-18, R10-19P, R10-19aP)*Option:*

01 A TRAFFIC LAWS PHOTO ENFORCED (R10-18) sign (see Figure 2B-3) may be installed at a jurisdictional boundary to advise road users that some of the traffic regulations within that jurisdiction are being enforced by photographic equipment.

02 A Photo Enforced (R10-19P) plaque or a PHOTO ENFORCED (R10-19aP) word message plaque (see Figure 2B-3) may be mounted below a regulatory sign to advise road users that the regulation is being enforced by photographic equipment.

Standard:

- 03 If used below a regulatory sign, the PHOTO ENFORCED (R10-19P or R10-19aP) plaque shall be a rectangle with a black legend and border on a white background.

Section 2B.56 Ramp Metering Signs (R10-28 and R10-29)

Option:

- 01 When ramp control signals (see Chapter 4I) are used to meter traffic on a freeway or expressway entrance ramp, regulatory signs with legends appropriate to the control may be installed adjacent to the ramp control signal faces.

- 02 For entrance ramps with only one controlled lane, an XX VEHICLE(S) PER GREEN (R10-28) sign (see Figure 2B-28) may be used to inform road users of the number of vehicles that are permitted to proceed during each short display of the green signal indication. For entrance ramps with more than one controlled lane, an XX VEHICLE(S) PER GREEN EACH LANE (R10-29) (see Figure 2B-28) sign may be used to inform road users of the number of vehicles that are permitted to proceed from each lane during each short display of the green signal indication.

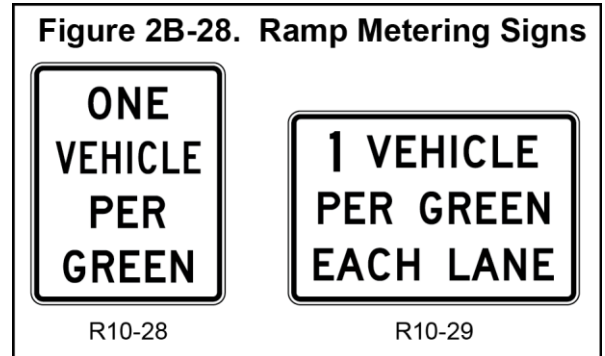

Section 2B.57 KEEP OFF MEDIAN Sign (R11-1)

Option:

- 01 The KEEP OFF MEDIAN (R11-1) sign (see Figure 2B-29) may be used to prohibit driving into or parking on the median.

Guidance:

- 02 The KEEP OFF MEDIAN sign should be installed on the left of the roadway within the median at random intervals as needed wherever there is a tendency for encroachment.

Section 2B.58 ROAD CLOSED Sign (R11-2) and LOCAL TRAFFIC ONLY Signs (R11-3 Series, R11-4)

Guidance:

- 01 The ROAD CLOSED (R11-2) sign should be installed where roads have been closed to all traffic (except authorized vehicles).
- 02 ROAD CLOSED—LOCAL TRAFFIC ONLY (R11-3 series) or ROAD CLOSED TO THRU TRAFFIC (R11-4) signs should be used where through traffic is not permitted, or for a closure some distance beyond the sign, but where the highway is open for local traffic up to the point of closure.

Standard:

- 03 The Road Closed (R11-2, R11-3 series, and R11-4) signs (see Figure 2B-29) shall be designed as horizontal rectangles. These signs shall be preceded by the applicable Advance Road Closed warning sign with the secondary legend AHEAD and, if applicable, an Advance Detour warning sign (see Section 6F.19).

Option:

- 04 An intersecting street name or a well-known destination may be substituted for the XX MILES AHEAD legend in urban areas.
- 05 The word message BRIDGE OUT may be substituted for the ROAD CLOSED legend where applicable.

Section 2B.59 Weight Limit Signs (R12-1 through R12-H5)

Option:

- 01 The Weight Limit (R12-1) sign carrying the legend WEIGHT LIMIT XX TONS may be used to indicate vehicle weight restrictions including load.

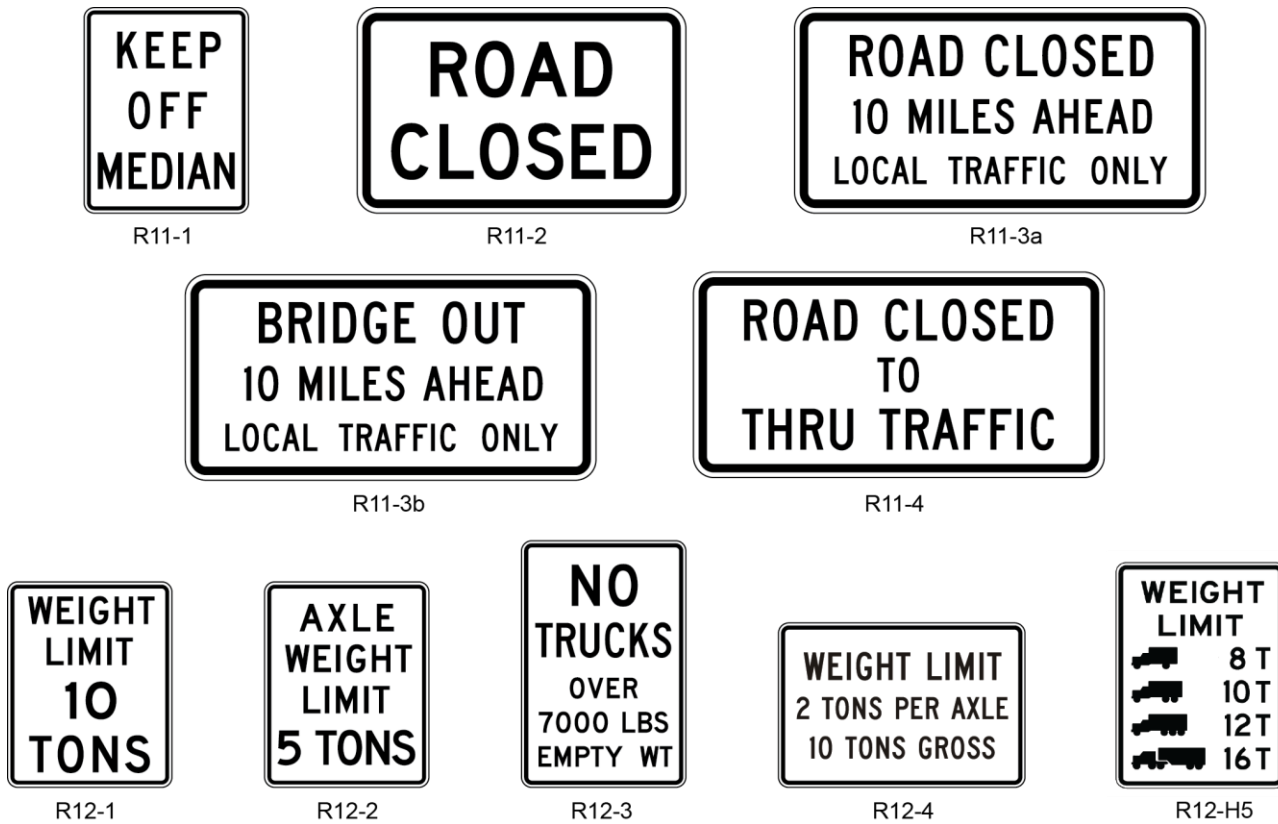
Figure 2B-29. Road Closed and Weight Limit Signs

02 Where the restriction applies to axle weight rather than gross load, the legend may be AXLE WEIGHT
 03 LIMIT XX TONS or AXLE WEIGHT LIMIT XX LBS (R12-2).

04 To restrict trucks of certain sizes by reference to empty weight in residential areas, the legend may be
 05 NO TRUCKS OVER XX TONS EMPTY WT or NO TRUCKS OVER XX LBS EMPTY WT (R12-3).

06 In areas where multiple regulations of the type described in Paragraphs 1 through 3 are applicable, a sign
 07 combining the necessary messages on a single sign may be used, such as WEIGHT LIMIT XX TONS PER
 08 AXLE, XX TONS GROSS (R12-4).

09 Posting of specific load limits may be accomplished by use of the Weight Limit symbol sign (R12-H5).
 10 A sign containing the legend WEIGHT LIMIT on the top two lines, and showing four different truck symbols
 11 and their respective weight limits for which restrictions apply may be used, with the weight limits displayed
 12 to the right of each symbol as XX T. A bottom line of legend stating GROSS WT may be included if needed
 13 for enforcement purposes.

Standard:

06 **If used, the Weight Limit sign (see Figure 2B-29) shall be located in advance of the applicable
 07 section of highway or structure.**

Guidance:

07 *If used, the Weight Limit sign with an advisory distance ahead legend should be placed at approach road
 08 intersections or other points where prohibited vehicles can detour or turn around.*

Support:

08 Section 5591.42 of the Ohio Revised Code (ORC) (see Appendix B2) authorizes reductions in bridge
 weight limits.

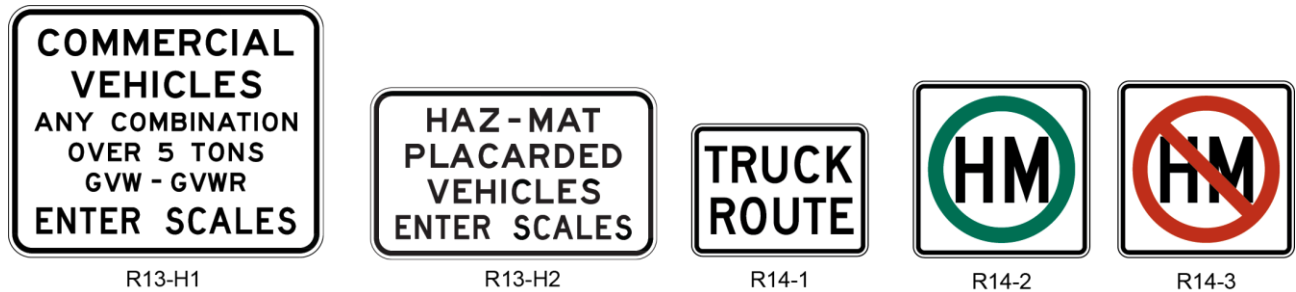
Figure 2B-30. Truck Signs**Section 2B.60 Weigh Station Signs (R13 Series)***Guidance:*

- 01 The COMMERCIAL VEHICLES ANY COMBINATION OVER 5 TONS GVW-GVWR ENTER SCALES (R13-H1) and HAZ-MAT PLACARDED VEHICLES ENTER SCALES (R13-H2) signs (see Figure 2B-30) should be used to direct appropriate traffic into a weigh station.
- 02 The R13-H1 and R13-H2 signs should be supplemented by the D8 series of guide signs (see Section 2D.49).

Section 2B.61 TRUCK ROUTE Sign (R14-1)*Guidance:*

- 01 The TRUCK ROUTE (R14-1) sign (see Figure 2B-30) should be used to mark a route that has been designated to allow truck traffic.

Option:

- 02 On a numbered highway, the TRUCK (M4-4) auxiliary sign may be used (see Section 2D.20).

Section 2B.62 Hazardous Material Signs (R14-2, R14-3)*Option:*

- 01 The Hazardous Material Route (R14-2) sign (see Figure 2B-30) may be used to identify routes that have been designated by proper authority for vehicles transporting hazardous material.
- 02 On routes where the transporting of hazardous material is prohibited, the Hazardous Material Prohibition (R14-3) sign (see Figure 2B-30) may be used.

Guidance:

- 03 If used, the Hazardous Material Prohibition sign should be installed on a street or roadway at a point where vehicles transporting hazardous material have the opportunity to take an alternate route.

Section 2B.63 National Network Signs (R14-1, R14-5)*Support:*

- 01 All state highways in Ohio have been designated as part of the National Network. Therefore, the special truck routing National Network signs addressed in Section 2B.63 of the Manual on Uniform Traffic Control Devices published by FHWA are not used in Ohio.

Section 2B.64 Headlight Use Signs (R16-5 through R16-11)*Support:*

- 01 Some States require road users to turn on their vehicle headlights under certain weather conditions, as a safety improvement measure on roadways experiencing high crash rates, or in special situations such as when driving through a tunnel. In Ohio, this is addressed in ORC Section 4513.03.
- 02 Figure 2B-31 shows the various signs that can be used for informing motorists of these requirements.

Figure 2B-31. Headlight Use Signs

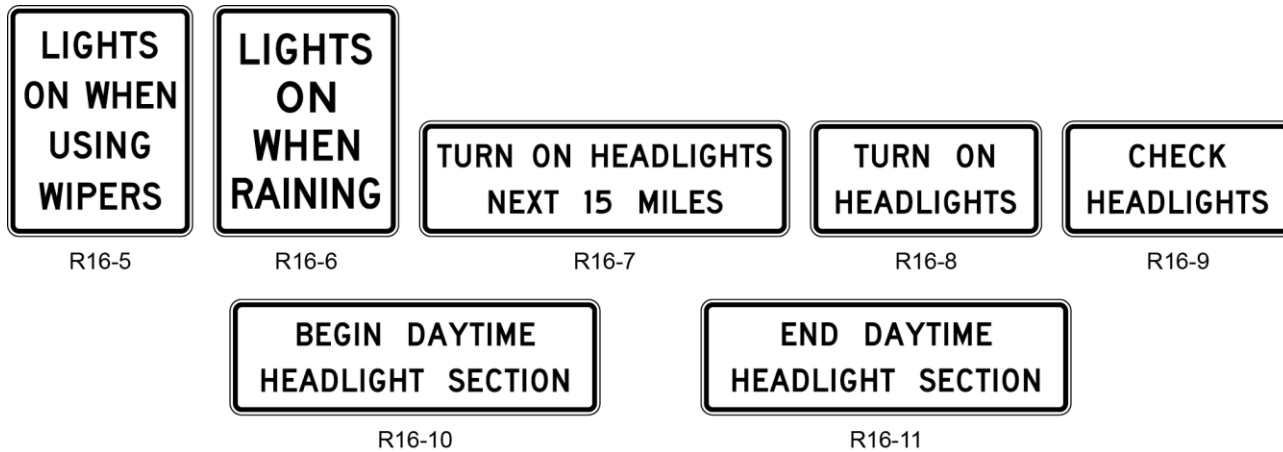

Option:

- 03 A LIGHTS ON WHEN USING WIPERS (R16-5) sign or a LIGHTS ON WHEN RAINING (R16-6) sign may be installed to inform road users of State laws regarding headlight use. Although these signs are typically installed facing traffic entering the State just inside the State border, they also may be installed at other locations within the State.

Guidance:

- 04 *If a particular section of roadway has been designated as a safety improvement zone within which headlight use is required, a TURN ON HEADLIGHTS NEXT XX MILES (R16-7) sign or a BEGIN DAYTIME HEADLIGHT SECTION (R16-10) sign should be installed at the upstream end of the section, and a END DAYTIME HEADLIGHT SECTION (R16-11) sign should be installed at the downstream end of the section.*

Option:

- 05 A TURN ON HEADLIGHTS (R16-8) sign may be installed to require road users to turn on their headlights in special situations such as when driving through a tunnel. A CHECK HEADLIGHTS (R16-9) sign may be installed downstream from the special situation to inform drivers that the using their headlights is no longer required.

Section 2B.65 FENDER BENDER Sign (R16-4)

Option:

- 01 A FENDER BENDER MOVE VEHICLES FROM TRAVEL LANES (R16-4) sign (see Figure 2B-32) may be installed to require motorists to move their vehicle out of the travel lanes if they have been involved in a crash.

Section 2B.66 Seat Belt Sign (R16-H1)

Support:

- 01 The MUTCD has established a standard seat belt symbol which has been incorporated into the Seat Belt sign shown in Figure 2B-32.

Option:

- 02 The Seat Belt (R16-H1) sign may be used to remind road users of the provisions of ORC Section 4513.263 regarding the use of “occupant restraining devices.”

Section 2B.67 Barricades

Option:

- 01 Barricades may be used to mark any of the following conditions:

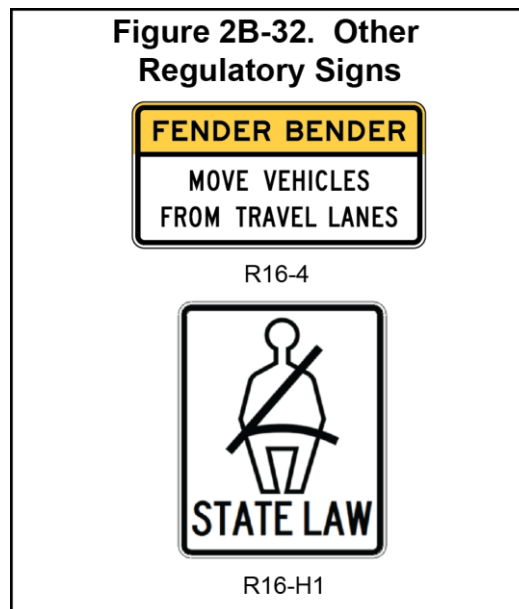

- A. A roadway ends,
- B. A ramp or lane closed for operational purposes, or
- C. The permanent or semi-permanent closure or termination of a roadway.

Standard:

- 02 **When used to warn and alert road users of the terminus of a roadway in other than temporary traffic control zones, barricades shall meet the design criteria of Section 6F.68 for a Type 3 Barricade, except that the colors of the stripes shall be retroreflective white and retroreflective red.**

Option:

- 03 An end-of-roadway marker or markers may be used as described in Section 2C.66.

Guidance:

- 04 *Appropriate advance warning signs (see Chapter 2C) should be used.*

Section 2B.68 Gates

Support:

- 01 Gates described in this section used for weather or other emergency conditions are typically permanently installed to enable the gate to be immediately deployed as needed to prohibit the entry of traffic to the highway segment(s).
- 02 A gate typically features a gate arm that is moved from a vertical to a horizontal position or is rotated in a horizontal plane from parallel to traffic to perpendicular to traffic. Traffic is obstructed and required to stop when the gate arm is placed in a horizontal position perpendicular to traffic. Another type of gate consists of a segment of fence (usually on rollers) that swings open and closed, or that is retracted to open and then extended to close.
- 03 Gates are sometimes used to enforce a required stop. Some examples of such uses are the following:
- A. Parking facility entrances and exits,
 - B. Private community entrances and exits,
 - C. Military base entrances and exits,
 - D. Toll plaza lanes,
 - E. Movable bridges (see Chapter 4J),
 - F. Automated Flagger Assistance Devices (see Chapter 6E), and
 - G. Grade crossings (see Part 8).
- 04 Gates are sometimes used to periodically close a roadway or a ramp. Some examples of such uses are the following:
- A. Closing ramps to implement counter-flow operations for evacuations,
 - B. Closing ramps that lead to reversible lanes, and
 - C. Closing roadways for weather events such as snow, ice, or flooding, or for other emergencies.

Standard:

- 05 **Except as provided in Paragraph 6, gate arms, if used, shall be fully retroreflectORIZED on both sides, have vertical stripes alternately red and white at 16-inch intervals measured horizontally as shown in Figure 8C-1.**

Option:

- 06 If used on a one-way roadway or ramp, the retroreflectorization may be omitted on the side of the gate facing away from approaching traffic.
- 07 Where gate arms are used to block off ramps into reversible lanes or to redirect approaching traffic, the red and white striping may be angled such that the stripes slope downward at an angle of 45 degrees toward the side of the gate arm on which traffic is to pass.

Standard:

- 08 **The gate arm shall extend across the approaching lane or lanes of traffic to effectively block motor vehicle and/or pedestrian travel as appropriate.**

09 **When gate arms are in the vertical position or rotated to an open position, the closest part of the gate arm and support shall have a lateral offset of at least 2 feet from the face of the curb or the edge of the traveled way.**

10 **When gate arms that are located in the median or on an island are in the horizontal position or rotated to a closed position, the closest part of the counterweight or its supports shall have a lateral offset of at least 2 feet from the face of the curb or the edge of the traveled way of the open roadway on the opposite side of the median or island.**

Guidance:

11 *When a gate that is rotated in a horizontal plane is in the position where it is parallel to traffic (indicating that the roadway is open), the outer end of the gate arm should be rotated to the downstream direction (from the perspective of traffic in the lane adjacent to the gate support) to prevent spearing if the gate is struck by an errant vehicle.*

12 *If a pedestrian route is present and if it is not intended that pedestrian traffic be controlled by the gate, a minimum of 2 feet of lateral offset from supports, posts, counterweights, and gate mechanisms should be provided when the gate arm is in the open position and when the gate arm is in the closed position such that pedestrian travel is not impeded.*

Option:

13 Red lights may be attached to traffic gates.

Standard:

14 **If red lights are attached to a traffic gate, the red lights shall be steadily illuminated or flashed only during the period when the gate is in the horizontal or closed position and when the gate is in the process of being opened or closed.**

15 **Except as provided in Paragraph 16, rolling sections of fence, if used, shall include either a horizontal strip of retroreflectorized sheeting on both sides of the fence with vertical stripes alternately red and white at 16-inch intervals measured horizontally to simulate the appearance of a gate arm in the horizontal position, or one or more Type 4 object markers (see Section 2C.66), or both. If a horizontal strip of retroreflectorized sheeting is used, the bottom of the sheeting shall be located 3.5 to 4.5 feet above the roadway surface.**

Option:

16 *If used on a one-way roadway or ramp, the retroreflectorization may be omitted on the side of the fence facing away from approaching traffic.*

CHAPTER 2C. WARNING SIGNS AND OBJECT MARKERS

Section 2C.01 Function of Warning Signs

Support:

- 01 Warning signs call attention to unexpected conditions on or adjacent to a highway, street, or private roads open to public travel and to situations that might not be readily apparent to road users. Warning signs alert road users to conditions that might call for a reduction of speed or an action in the interest of safety and efficient traffic operations.

Section 2C.02 Application of Warning Signs

Standard:

- 01 **The use of warning signs shall be based on an engineering study or on engineering judgment.**

Guidance:

- 02 *The use of warning signs should be kept to a minimum as the unnecessary use of warning signs tends to breed disrespect for all signs. In situations where the condition or activity is seasonal or temporary, the warning sign should be removed or covered when the condition or activity does not exist.*

Option:

- 03 Consistent with the provisions of Chapter 2L, changeable message signs may be used to display a warning message.
- 04 Consistent with the provisions of Chapter 4L, a Warning Beacon may be used in combination with a standard warning sign.

Support:

- 05 The categories of warning signs are shown in Table 2C-1.
- 06 Warning signs provided in this Manual cover most of the conditions that are likely to be encountered. Additional warning signs for low-volume roads (as defined in Section 5A.01), temporary traffic control zones, school areas, grade crossings, and bicycle facilities are discussed in Parts 5 through 9 respectively.
- 07 Section 1A.09 contains information regarding the assistance that is available to jurisdiction that do not have engineers on their staffs who are trained and/or experienced in traffic control devices.

Section 2C.03 Design of Warning Signs

Standard:

- 01 **Except as provided in Paragraph 2 or unless specifically designated otherwise, all warning signs shall be diamond-shaped (square with one diagonal vertical) with a black legend and border on a yellow background. Warning signs shall be designed in accordance with the sizes, shapes, colors, and legends contained in the “Sign Designs and Markings Manual” (SDMM) (see Section 1A.11).**

Option:

- 02 A warning sign that is larger than the size shown in the Oversized column in Table 2C-2 for that particular sign may be diamond-shaped or may be rectangular or square in shape.
- 03 Except for symbols on warning signs, minor modifications may be made to the design provided that the essential appearance characteristics are met. Modifications may be made to the symbols shown on combined horizontal alignment/intersection signs (see Section 2C.11) and intersection warning signs (see Section 2C.46) in order to approximate the geometric configuration of the intersecting roadway(s).
- 04 Word message warning signs other than those provided in this Manual may be developed and installed by State and local highway agencies.
- 05 Warning signs regarding conditions associated with pedestrians, bicyclists, and playgrounds may have a black legend and border on a yellow or fluorescent yellow-green background.

Standard:

- 06 **Warning signs regarding conditions associated with school buses and schools and their related supplemental plaques shall have a black legend and border on a fluorescent yellow-green background (see Section 7B.07).**

Table 2C-1. Categories of Warning Signs and Plaques

Category	Group	Section	Signs or Plaques	Sign Designations
Roadway Related	Changes in Horizontal Alignment	2C.07	Turn, Curve, Reverse Turn, Reverse Curve, Winding Road, Hairpin Curve, 270-Degree Curve	W1-1, 2, 3, 4, 5, 11, 15
		2C.08	Advisory Speed	W13-1P
		2C.09	Chevron Alignment	W1-8
		2C.10	Combination Horizontal Alignment/Advisory Speed	W1-1a, 2a
		2C.11	Combination Horizontal Alignment/Intersection	W1-10, 10a, 10b, 10c, 10d
		2C.12	Large Arrow (one direction)	W1-6
		2C.13	Truck Rollover	W1-13
		2C.14	Advisory Exit or Ramp Speed	W13-2,3
	Vertical Alignment	2C.15	Combination Horizontal Alignment/Advisory Exit or Ramp Speed	W13-6,7
		2C.16	Hill	W7-1, 1a, 2P, 2bP, 3P, 3aP, 3bP
		2C.17	Truck Escape Ramp	W7-4, 4b, 4c, 4dP, 4eP, 4fP
	Cross Section	2C.18	HILL BLOCKS VIEW	W7-6
		2C.19	ROAD NARROWS	W5-1
		2C.20,21	NARROW BRIDGE, ONE LANE BRIDGE	W5-2, 3
		2C.22,23,25	Divided Highway, Divided Highway Ends, Double Arrow	W6-1, 2; W12-1
		2C.24	Freeway or Expressway Ends, ALL TRAFFIC MUST EXIT	W19-1, 2, 3, 4, 5
		2C.26	DEAD END, NO OUTLET	W14-1, 1a, 2, 2a
		2C.27	Low Clearance	W12-2, 2a
	Roadway Surface Condition	2C.28,29	BUMP, DIP, SPEED HUMP	W8-1, 2; W17-1
		2C.30	PAVEMENT ENDS	W8-3
		2C.31	Shoulder, UNEVEN LANES	W8-4, 9, 11, 17, 17P, 23, 25
2C.32		Slippery When Wet, LOOSE GRAVEL, ROUGH ROAD, BRIDGE ICES BEFORE ROAD, FALLEN ROCKS	W8-5,7,8,13,14	
2C.33		GROOVED PAVEMENT, METAL BRIDGE DECK	W8-15, 15P, 16	
Weather	2C.34	NO CENTER LINE, NO EDGE LINE	W8-12, W8-H12a	
	2C.35	ROAD MAY FLOOD, Flood Gauge, GUSTY WINDS AREA, FOG AREA	W8-18, 19, 21, 22	
Traffic Related	Advance Traffic Control	2C.36-39	Stop Ahead, Yield Ahead, Signal Ahead, BE PREPARED TO STOP, Speed Reduction, DRAW BRIDGE AHEAD, RAMP METER AHEAD	W3-1, 2, 3, 4, 5, 5a, 6, 7, 8
	Traffic Flow	2C.40-45	Merge, NO MERGE AREA, Lane Ends, Added Lane, Two-Way Traffic, RIGHT LANE EXIT ONLY AHEAD, NO PASSING ZONE	W4-1, 2, 3, 5, 5P, 6; W6-3; W9-1, 2, 7; W14-3
	Intersections	2C.46	Cross Road, Side Road, T, Y, Circular Intersection, Side Roads	W2-1, 2, 3, 4, 5, 6, 7, 8; W16-12P, 17P
		2C.47	Large Arrow (two directions)	W1-7
		2C.48	Oncoming Extended Green	W25-1, 2
	Vehicular Traffic	2C.49	TRUCK CROSSING, Truck (symbol), Emergency Vehicle, Tractor, Bicycle, Golf Cart, Horse-Drawn Vehicle, Trail Crossing	W8-6; W11-1, 5, 5a, 8, 10, 11, 12 P, 14, 15, 15P, 15a; W16-13P
	Non-Vehicular	2C.50,51	Pedestrian, Deer, Cattle, Snowmobile, Equestrian, Wheelchair, Large Animals, Playground	W11-2, 3, 4, 6, 7, 9, 16, 17, 18, 19, 20, 21, 22; W15-1; W16-13P
New	2C.52	NEW TRAFFIC PATTERN AHEAD	W23-2	
Other Supplemental Plaques	Location	2C.53	Downward Diagonal Arrow, Ahead	W16-7P, 9P
	HOV	2C.53	High-Occupancy Vehicle	W16-11P
	Distance	2C.55	XX FEET, XX MILES, NEXT XX FEET, NEXT XX MILES	W7-3aP; W16-2P, 2aP, 3P, 3aP, 4P
	Arrow	2C.56	Advance Arrow, Directional Arrow	W16-5 P, 6 P
	Street Name Plaque	2C.58	Advance Street Name	W16-8 P, 8aP
	Intersection	2C.59	CROSS TRAFFIC DOES NOT STOP	W4-4P, 4aP, 4bP
	Share The Road	2C.60	SHARE THE ROAD	W16-1P
	Photo Enforced	2C.61	Photo Enforced	W16-10P, 10aP
New	2C.62	NEW	W16-15P	

Table 2C-2. Warning Sign and Plaque Sizes¹ (Sheet 1 of 4)

Sign or Plaque	Sign Designation	Section	Conventional Road		Expressway	Freeway	Minimum	Oversized
			Single Lane	Multi-Lane				
Horizontal Alignment	W1-1, 2, 3, 4, 5	2C.07	30 x 30	36 x 36	36 x 36		—	48 x 48
Combination Horizontal Alignment / Advisory Speed	W1-1a, 2a	2C.10	36 x 36		48 x 48		—	48 x 48
One-Direction Large Arrow	W1-6	2C.12	48 x 24		60 x 30		—	60 x 30
Two-Direction Large Arrow	W1-7	2C.47	48 x 24		—		—	60 x 30
Chevron Alignment	W1-8	2C.09	18 x 24		30 x 36	36 x 48	—	24 x 30
Combination Horizontal Alignment / Intersection	W1-10, 10a, 10b, 10c, 10d, 10e	2C.11	36 x 36		36 x 36	48 x 48	—	—
Hairpin Curve	W1-11	2C.07	30 x 30	36 x 36 ²	36 x 36	48 x 48	—	48 x 48
Truck Rollover	W1-13	2C.13	36 x 36		36 x 36	48 x 48	—	36 x 36
270-degree Loop	W1-15	2C.07	30 x 30	36 x 36 ²	36 x 36	48 x 48	—	48 x 48
Intersection Warning	W2-1, 2, 3, 4, 5, 6, 7, 8	2C.46	30 x 30	36 x 36 ²	36 x 36	—	24 x 24	48 x 48
Advance Traffic Control	W3-1, 2, 3	2C.36	30 x 30	36 x 36 ²	48 x 48		30 x 30	—
Be Prepared to Stop	W3-4	2C.36	36 x 36		48 x 48		30 x 30	—
Reduced Speed Limit Ahead	W3-5	2C.38	36 x 36		48 x 48		—	—
XX MPH SPEED ZONE AHEAD	W3-5a	2C.38	36 x 36		48 x 48		—	—
DRAW BRIDGE	W3-6	2C.39	36 x 36		48 x 48	—	—	60 x 60
RAMP METER AHEAD	W3-7	2C.37	36 x 36		—		—	—
RAMP METERED WHEN FLASHING	W3-8	2C.37	36 x 36		—		—	—
Merge	W4-1	2C.40	36 x 36		48 x 48		30 x 30	—
Lane Ends	W4-2	2C.42	36 x 36		48 x 48		30 x 30	—
Added Lane	W4-3	2C.41	36 x 36		48 x 48		30 x 30	—
CROSS TRAFFIC DOES NOT STOP (plaque)	W4-4P	2C.59	24 x 12		36 x 18	—	—	48 x 24
TRAFFIC FROM LEFT (RIGHT) DOES NOT STOP (plaque)	W4-4aP	2C.59	24 x 12		36 x 18	—	—	48 x 24
ONCOMING TRAFFIC DOES NOT STOP (plaque)	W4-4bP	2C.59	24 x 12		36 x 18	—	—	48 x 24
Entering Roadway Merge	W4-5	2C.40	36 x 36		48 x 48	—	—	—
NO MERGE AREA (plaque)	W4-5P	2C.40	18 x 24		24 x 30	—	—	—
Entering Roadway Added Lane	W4-6	2C.41	36 x 36		48 x 48	—	—	—
ROAD NARROWS	W5-1	2C.19	36 x 36		48 x 48		30 x 30	—
NARROW BRIDGE	W5-2	2C.20	36 x 36		48 x 48		30 x 30	—
ONE LANE BRIDGE	W5-3	2C.21	36 x 36		48 x 48		30 x 30	—
Divided Highway	W6-1	2C.22	36 x 36		48 x 48		—	—

Table 2C-2. Warning Sign and Plaque Sizes¹ (Sheet 2 of 4)

Sign or Plaque	Sign Designation	Section	Conventional Road		Expressway	Freeway	Minimum	Oversized
			Single Lane	Multi-Lane				
Divided Highway Ends	W6-2	2C.23	36 x 36		48 x 48	—	—	
Two-Way Traffic	W6-3	2C.44	36 x 36		48 x 48	—	—	
Hill	W7-1	2C.16	30 x 30	36 x 36	36 x 36	24 x 24	48 x 48	
Hill with Grade	W7-1a	2C.16	30 x 30	36 x 36	36 x 36	24 x 24	48 x 48	
USE LOW GEAR (plaque)	W7-2P	2C.57	24 x 18		—	—	—	
TRUCKS USE LOWER GEAR (plaque)	W7-2bP	2C.57	24 x 18		—	—	—	
XX% Grade (plaque)	W7-3P	2C.57	24 x 18		—	—	—	
NEXT XX MILES (plaque)	W7-3aP	2C.55	24 x 18		—	—	—	
XX% Grade, XX Miles (plaque)	W7-3bP	2C.57	24 x 18		—	—	—	
RUNAWAY TRUCK RAMP XX MILES	W7-4	2C.17	78 x 48		78 x 48	—	—	
RUNAWAY TRUCK RAMP (with arrow)	W7-4b	2C.17	78 x 60		78 x 60	—	—	
TRUCK ESCAPE RAMP	W7-4c	2C.17	78 x 60		78 x 60	—	—	
SAND, GRAVEL, PAVED (plaques)	W7-4dP, 4eP, 4fP	2C.17	24 x 12		24 x 12	—	—	
HILL BLOCKS VIEW	W7-6	2C.18	30 x 30	36 x 36	36 x 36	—	48 x 48	
BUMP or DIP	W8-1,2	2C.28	30 x 30	36 x 36	36 x 36	48 x 48	24 x 24	
PAVEMENT ENDS	W8-3	2C.30	36 x 36		48 x 48	—	30 x 30	
SOFT SHOULDER	W8-4	2C.31	36 x 36		48 x 48	24 x 24	48 x 48	
Slippery When Wet	W8-5	2C.32	30 x 30	36 x 36	36 x 36	48 x 48	24 x 24	
Road Condition (plaques)	W8-5P, 5bP, 5cP	2C.32	24 x 18		30 x 24	36 x 30	—	
ICE	W8-5aP	2C.32	24 x 12		30 x 18	—	—	
TRUCK CROSSING	W8-6	2C.49	36 x 36		36 x 36	48 x 48	24 x 24	
LOOSE GRAVEL	W8-7	2C.32	36 x 36		36 x 36	—	24 x 24	
ROUGH ROAD	W8-8	2C.32	36 x 36		36 x 36	48 x 48	24 x 24	
LOW SHOULDER	W8-9	2C.31	36 x 36		36 x 36	48 x 48	24 x 24	
UNEVEN LANES	W8-11	2C.32	36 x 36		36 x 36	48 x 48	—	
NO CENTER LINE	W8-12	2C.34	36 x 36		36 x 36	48 x 48	—	
NO EDGE LINE	W8-H12a	2C.34	36 x 36		36 x 36	48 x 48	—	
BRIDGE ICES BEFORE ROAD	W8-13	2C.32	36 x 36		36 x 36	48 x 48	24 x 24	
FALLEN ROCKS	W8-14	2C.32	30 x 30	36 x 36	36 x 36	48 x 48	24 x 24	
GROOVED PAVEMENT	W8-15	2C.33	30 x 30	36 x 36	36 x 36	48 x 48	24 x 24	
Motorcycle (plaque)	W8-15P	2C.33	24 x 18		30 x 24	36 x 30	—	
METAL BRIDGE DECK	W8-16	2C.33	30 x 30	36 x 36	36 x 36	48 x 48	24 x 24	
Shoulder Drop-Off (symbol)	W8-17	2C.31	30 x 30	36 x 36	36 x 36	48 x 48	24 x 24	
SHOULDER DROP-OFF (plaque)	W8-17P	2C.31	24 x 18		30 x 24	36 x 30	—	

Table 2C-2. Warning Sign and Plaque Sizes¹ (Sheet 3 of 4)

Sign or Plaque	Sign Designation	Section	Conventional Road		Expressway	Freeway	Minimum	Oversized
			Single Lane	Multi-Lane				
ROAD MAY FLOOD	W8-18	2C.35	36 x 36		36 x 36	48 x 48	24 x 24	48 x 48
Flood Gauge	W8-19	2C.35	12 x 72		—	—	—	—
GUSTY WINDS AREA	W8-21	2C.35	36 x 36		36 x 36	48 x 48	24 x 24	48 x 48
FOG AREA	W8-22	2C.35	36 x 36		36 x 36	48 x 48	24 x 24	48 x 48
NO SHOULDER	W8-23	2C.31	36 x 36		36 x 36	48 x 48	24 x 24	48 x 48
SHOULDER ENDS	W8-25	2C.31	30 x 30	36 x 36	36 x 36	48 x 48	24 x 24	48 x 48
LEFT (RIGHT) LANE ENDS	W9-1	2C.42	36 x 36		36 x 36	48 x 48	30 x 30	48 x 48
LANE ENDS MERGE LEFT (RIGHT)	W9-2	2C.42	36 x 36		36 x 36	48 x 48	30 x 30	48 x 48
RIGHT (LEFT) LANE EXIT ONLY AHEAD	W9-7	2C.43	132 x 72		132 x 72		—	—
Bicycle	W11-1	2C.49	30 x 30	36 x 36 ²	36 x 36	—	24 x 24	48 x 48
Pedestrian	W11-2	2C.50	30 x 30	36 x 36	36 x 36	—	24 x 24	48 x 48
Large Animals	W11-3, 4, 16, 17	2C.50	30 x 30	36 x 36	36 x 36	—	24 x 24	48 x 48
Farm Vehicle	W11-5, 5a	2C.49	30 x 30	36 x 36	36 x 36	—	24 x 24	48 x 48
Snowmobile	W11-6	2C.50	30 x 30	36 x 36	36 x 36	—	24 x 24	48 x 48
Equestrian	W11-7	2C.50	30 x 30	36 x 36	36 x 36	—	24 x 24	48 x 48
Emergency Vehicle	W11-8	2C.49	30 x 30	36 x 36	36 x 36	—	24 x 24	48 x 48
Handicapped	W11-9	2C.50	30 x 30	36 x 36	36 x 36	—	—	48 x 48
Truck	W11-10	2C.49	30 x 30	36 x 36	36 x 36	—	24 x 24	48 x 48
Golf Cart	W11-11	2C.49	30 x 30	36 x 36	36 x 36	—	24 x 24	48 x 48
EMERGENCY SIGNAL AHEAD (plaque)	W11-12P	2C.49	36 x 30		36 x 30	—	—	—
Horse-Drawn Vehicle	W11-14	2C.49	30 x 30	36 x 36	36 x 36	—	24 x 24	48 x 48
Bicycle / Pedestrian	W11-15	2C.49	30 x 30	36 x 36	36 x 36	—	24 x 24	48 x 48
TRAIL CROSSING	W11-15a	2C.49	30 x 30	36 x 36	36 x 36	—	24 x 24	48 x 48
TRAIL X-ING (plaque)	W11-15P	2C.49	24 x 18		30 x 24	—	—	36 x 30
Double Arrow	W12-1	2C.25	30 x 30	36 x 36	36 x 36	—	—	—
Low Clearance (with arrows)	W12-2	2C.27	36 x 36		48 x 48		30 x 30	—
Low Clearance	W12-2a	2C.27	78 x 24		—		—	—
Advisory Speed (plaque)	W13-1P	2C.08	18 x 18		24 x 24	30 x 30	—	30 x 30
Advisory Exit or Ramp Speed	W13-2, 3	2C.14	24 x 30		36 x 48	48 x 60	—	48 x 60
Combination Horizontal Alignment / Advisory Exit or Ramp Speed	W13-6, 7	2C.15	24 x 42		36 x 60	48 x 84	—	48 x 84
DEAD END, NO OUTLET	W14-1, 2	2C.26	30 x 30	36 x 36	36 x 36	—	24 x 24	48 x 48
DEAD END, NO OUTLET (with arrow)	W14-1a, 2a	2C.26	36 x 8		—	—	—	—
NO PASSING ZONE (pennant)	W14-3	2C.45	48 x 48 x 36		—	—	40 x 40 x 30	64 x 64 x 48
Playground	W15-1	2C.51	30 x 30	36 x 36	36 x 36	—	24 x 24	48 x 48

Table 2C-2. Warning Sign and Plaque Sizes¹ (Sheet 4 of 4)

Sign or Plaque	Sign Designation	Section	Conventional Road		Expressway	Freeway	Minimum	Oversized
			Single Lane	Multi-Lane				
SHARE THE ROAD (plaque)	W16-1P	2C.60	18 x 24		24 x 30	—	—	24 x 30
XX FEET	W16-2P	2C.55	24 x 18		—	—	—	30 x 24
XX FT	W16-2aP	2C.55	24 x 12		—	—	—	30 x 18
XX MILES (2-line plaque)	W16-3P	2C.55	30 x 24		—	—	—	—
XX MILES (1-line plaque)	W16-3aP	2C.55	30 x 12		—	—	—	—
NEXT XX FT (plaque)	W16-4P	2C.55	30 x 24		—	—	—	—
Supplemental Arrow (plaque)	W16-5P, 6P	2C.56	24 x 18		—	—	—	—
Downward Diagonal Arrow (plaque)	W16-7P	2C.50	24 x 12		—	—	—	30 x 18
Advance Street Name (1-line plaque)	W16-8P	2C.58	varies x 8		—	—	—	—
Advance Street Name (2-line plaque)	W-16-8aP	2C.58	varies x 15		—	—	—	—
AHEAD (plaque)	W16-9P	2C.50	24 x 12		30 x 18	—	—	—
Photo Enforced (symbol plaque)	W16-10P	2C.61	24 x 12		36 x 18	—	—	48 x 24
PHOTO ENFORCED (plaque)	W16-10aP	2C.61	24 x 18		36 x 30	—	—	48 x 36
HOV (plaque)	W16-11P	2G.09	24 x 12		30 x 18	—	—	30 x 18
TRAFFIC CIRCLE (plaque)	W16-12P	2C.46	24 x 18		—	—	—	—
WHEN FLASHING (plaque)	W16-13P	2C.50	24 x 18		—	—	—	—
NEW (plaque)	W16-15P	2C.62	24 x 12		—	—	—	—
ROUNDBOUT (plaque)	W16-17P	2C.46	24 x 12		—	—	—	—
NOTICE	W16-18P	2A.15	24 x 12		—	—	—	—
SPEED HUMP	W17-1	2C.29	30 x 30	36 x 36	—	—	24 x 24	48 x 48
FREEWAY ENDS XX Miles	W19-1	2C.24	—		—	144 x 48	—	—
EXPRESSWAY ENDS XX Miles	W19-2	2C.24	—		144 x 48	—	—	—
FREEWAY ENDS	W19-3	2C.24	—		—	48 x 48	—	—
EXPRESSWAY ENDS	W19-4	2C.24	—		48 x 48	—	—	—
ALL TRAFFIC MUST EXIT	W19-5	2C.34	—		90 x 48	90 x 48	—	—
NEW TRAFFIC PATTERN AHEAD	W23-2	2C.52	36 x 36		—	—	—	—
Traffic Signal Extended Green	W25-1, 2	2C.48	24 x 30		—	—	—	—

Notes:

1. a.) Larger signs may be used when appropriate;
b.) Dimensions in inches are shown as width x height;
c.) See Table 9B-1 for minimum sizes required on bicycle facilities.
d.) See Sections 2A.11 and 2C.04 for additional information regarding sign sizes.
2. The minimum size for signs facing traffic on multi-lane conventional roads with a posted speed limit of 35 mph or less shall be 30 x 30 inches.

Section 2C.04 Size of Warning Signs

Standard:

01 Except as provided in Section 2A.11, the sizes for warning signs shall be as shown in Table 2C-2.

Support:

02 Section 2A.11 contains information regarding the applicability of the various columns in Table 2C-2.

Standard:

03 Except as provided in Paragraph 5, the minimum size for all diamond-shaped warning signs facing traffic on a multi-lane conventional road where the posted speed limit is higher than 35 mph shall be 36 x 36 inches.

Table 2C-3. Minimum Size of Supplemental Warning Plaques

Size of Warning Sign	Size of Supplemental Plaque			
	Rectangular			Square
	1 Line	2 Lines	Arrow	
24 x 24	24 x 12	24 x 18	24 x 12	18 x 18
30 x 30				
36 x 36	30 x 18	30 x 24	30 x 18	24 x 24
48 x 48				

Notes:

1. For supplemental warning plaques **not** in Table 2C-2.
2. Larger supplemental plaques may be used when appropriate.
3. Dimensions in inches are shown as width x height.

04 The minimum size for supplemental warning plaques that are not included in Table 2C-2 shall be as shown in Table 2C-3.

Option:

05 If a diamond-shaped warning sign is placed on the left-hand side of a multi-lane roadway to supplement the installation of the same warning sign on the right-hand side of the roadway, the minimum size identified in the Single Lane column in Table 2C-2 may be used.

06 Signs and plaques larger than those shown in Tables 2C-2 and 2C-3 may be used (see Section 2A.11).

Guidance:

07 The minimum size for all diamond-shaped warning signs facing traffic on exit and entrance ramps should be the size identified in Table 2C-2 for the mainline roadway classification (Expressway or Freeway). If a minimum size is not provided in the Freeway Column, the Expressway size should be used. If a minimum size is not provided in the Freeway or the Expressway Column, the Oversized size should be used.

Section 2C.05 Placement of Warning Signs

Support:

01 For information on placement of warning signs, see Sections 2A.16 to 2A.21.

02 The time needed for detection, recognition, decision, and reaction is called the Perception-Response Time (PRT). Table 2C-4 is provided as an aid for determining warning sign location. The distances shown in Table 2C-4 can be adjusted for roadway features, other signing, and to improve visibility.

Guidance:

03 Warning signs should be placed so that they provide an adequate PRT. The distances contained in Table 2C-4 are for guidance purposes and should be applied with engineering judgment. Warning signs should not be placed too far in advance of the condition, such that drivers might tend to forget the warning because of other driving distractions, especially in urban areas.

04 Minimum spacing between warning signs with different messages should be based on the estimated PRT for driver comprehension of and reaction to the second sign.

05 The effectiveness of the placement of warning signs should be periodically evaluated under both day and night conditions.

Option:

06 Warning signs that advise road users about conditions that are not related to a specific location, such as Deer Crossing or SOFT SHOULDER, may be installed in an appropriate location, based on engineering judgment, since they are not covered in Table 2C-4.

Table 2C-4. Guidelines for Advance Placement of Warning Signs

Posted or 85th-Percentile Speed	Advance Placement Distance ¹								
	Condition A: Speed Reduction and lane changing in heavy traffic ²	Condition B: Deceleration to the listed advisory speed (mph) for the condition							
		0 ³	10 ⁴	20 ⁴	30 ⁴	40 ⁴	50 ⁴	60 ⁴	70 ⁴
20 mph	225 ft	100 ft ⁶	N/A ⁵	—	—	—	—	—	—
25 mph	325 ft	100 ft ⁶	N/A ⁵	N/A ⁵	—	—	—	—	—
30 mph	460 ft	100 ft ⁶	N/A ⁵	N/A ⁵	—	—	—	—	—
35 mph	565 ft	100 ft ⁶	N/A ⁵	N/A ⁵	N/A ⁵	—	—	—	—
40 mph	670 ft	125 ft	100 ft ⁶	100 ft ⁶	N/A ⁵	—	—	—	—
45 mph	775 ft	175 ft	125 ft	100 ft ⁶	100 ft ⁶	N/A ⁵	—	—	—
50 mph	885 ft	250 ft	200 ft	175 ft	125 ft	100 ft ⁶	—	—	—
55 mph	990 ft	325 ft	275 ft	225 ft	200 ft	125 ft	N/A ⁵	—	—
60 mph	1,100 ft	400 ft	350 ft	325 ft	275 ft	200 ft	100 ft ⁶	—	—
65 mph	1,200 ft	475 ft	450 ft	400 ft	350 ft	275 ft	200 ft	100 ft ⁶	—
70 mph	1,250 ft	550 ft	525 ft	500 ft	450 ft	375 ft	275 ft	150 ft	—
75 mph	1,350 ft	650 ft	625 ft	600 ft	550 ft	475 ft	375 ft	250 ft	100 ft ⁶

¹ The distances are adjusted for a sign legibility distance of 180 feet for Condition A. The distances for Condition B have been adjusted for a sign legibility distance of 250 feet, which is appropriate for an alignment warning symbol sign. For Conditions A and B, warning signs with less than 6-inch legend of more than four words, a minimum of 100 feet should be added to the advance placement distance to provide adequate legibility of the warning sign.

² Typical conditions are locations where the road user must use extra time to adjust speed and change lanes in heavy traffic because of a complex driving situation. Typical signs are Merge and Right Lane Ends. The distances are determined by providing the driver a PRT time of 14.0 to 14.5 seconds for vehicle maneuvers (2004 AASHTO Policy, Exhibit 3-3, Decision Sight Distance, Avoidance Maneuver E) minus the legibility distance of 180 feet for the appropriate sign.

³ Typical condition is the warning of a potential stop situation. Typical signs are Stop Ahead, Yield Ahead, Signal Ahead, and Intersection Warning signs. The distances are based on the 2004 AASHTO Policy, Exhibit 3-1, Stopping Sight Distance, providing a PRT of 2.5 seconds, a deceleration rate of 11.2 feet/second², minus the sign legibility distance of 180 feet.

⁴ Typical Conditions are locations where the road user must decrease speed to maneuver through the warned condition. Typical signs are Turn, Curve, Reverse Turn, or Reverse Curve. The distance is determined by providing a 2.5 second PRT, a vehicle deceleration rate 10 feet/second², minus the sign legibility distance of 250 feet.

⁵ No suggested distances are provided for these speeds, as placement location is dependent on site conditions and other signing. An alignment warning sign may be placed anywhere from the point of curvature up to 100 feet in advance of the curve. However, the alignment warning sign should be installed in advance of the curve and at least 100 feet from any other signs.

⁶ The minimum advance placement distance is listed as 100 feet to provide adequate spacing between signs.

Section 2C.06 Horizontal Alignment Warning Signs

Support:

01 A variety of horizontal alignment warning signs (see Figure 2C-1), pavement markings (see Chapter 3B), and delineation (see Chapter 3F) can be used to advise motorists of a change in the roadway alignment. Uniform application of these traffic control devices with respect to the amount of change in the roadway alignment conveys a consistent message establishing driver expectancy and promoting effective roadway operations. The design and application of horizontal alignment warning signs to meet those requirements are addressed in Sections 2C.06 through 2C.15.

Standard:

02 **In advance of horizontal curves on freeways, on expressways, and on roadways with more than 1,000 AADT that are functionally classified as arterials or collectors, horizontal alignment warning signs shall be used in accordance with Table 2C-5 based on the speed differential between the roadway’s posted or statutory speed limit or 85th-percentile speed, or the prevailing speed on the approach to the curve, and the horizontal curve’s advisory speed.**

Option:

03 Horizontal alignment warning signs may also be used on other roadways or on arterial and collector roadways with less than 1,000 AADT based on engineering judgment.

Figure 2C-1. Horizontal Alignment Signs and Plaques

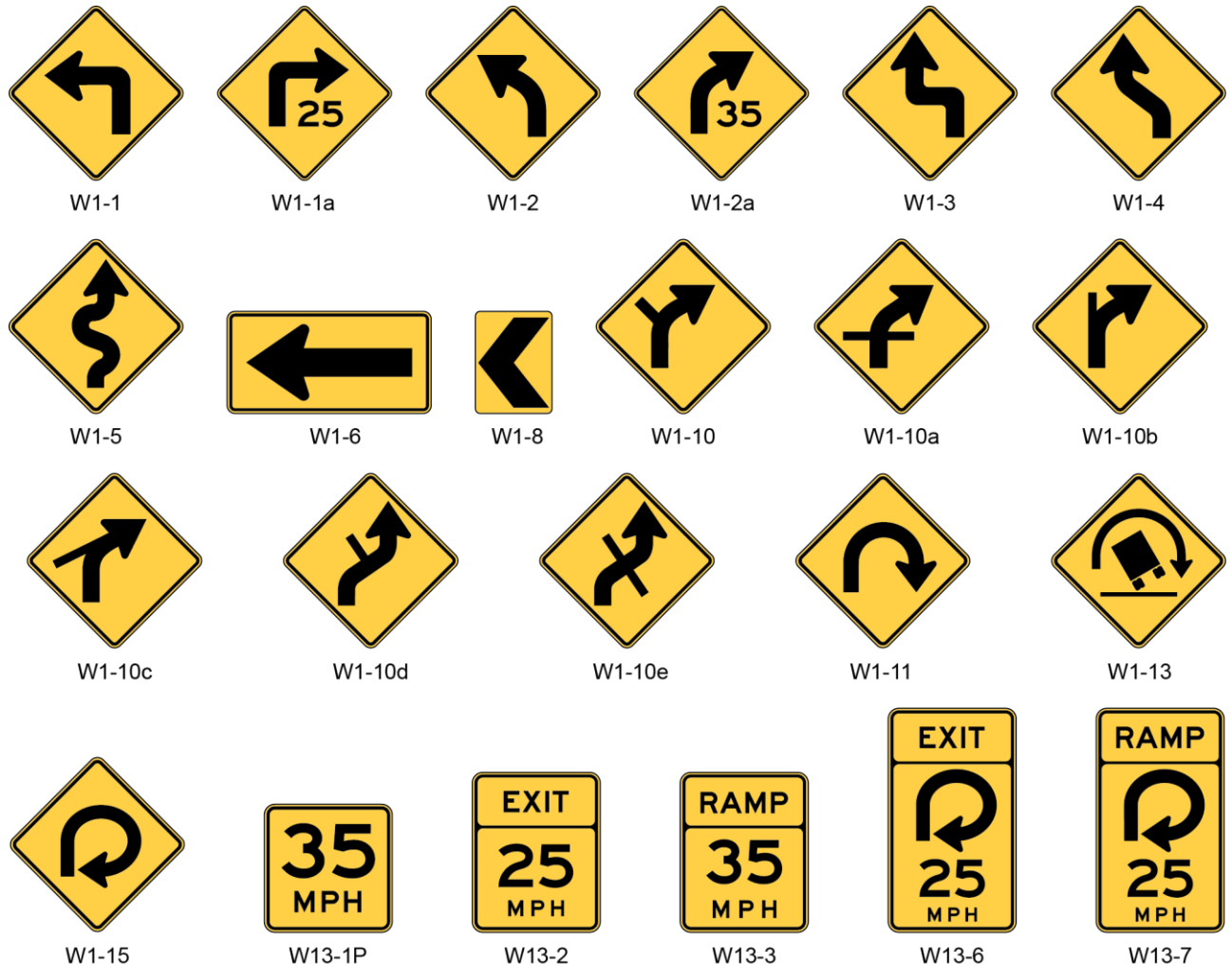

Note: Turn arrows and reverse turn arrows may be substituted for the curve arrows and reverse curve arrows on the W1-10 series signs where appropriate.

Section 2C.07 Horizontal Alignment Signs (W1-1 through W1-5, W1-11, W1-15)

Standard:

- 01 If Table 2C-5 indicates that a horizontal alignment sign (see Figure 2C-1) is required, recommended, or allowed, the sign installed in advance of the curve shall be a Curve (W1-2) sign unless a different sign is recommended or allowed by the provisions of this Section.
- 02 A Turn (W1-1) sign shall be used instead of a Curve sign in advance of curves that have advisory speeds of 30 mph or less (see Figure 2C-2).

Guidance:

- 03 Where there are two changes in roadway alignment in opposite directions that are separated by a tangent distance of less than 600 feet, the Reverse Turn (W1-3) sign should be used instead of multiple Turn (W1-1) signs and the Reverse Curve (W1-4) sign should be used instead of multiple Curve (W1-2) signs.

Option:

- 04 A Winding Road (W1-5) sign may be used instead of multiple Turn (W1-1) or Curve (W1-2) signs where there are three or more changes in roadway alignment each separated by a tangent distance of less than 600 feet.

A NEXT XX MILES (W7-3aP) supplemental distance plaque (see Section 2C.55) may be installed below the Winding Road sign where continuous roadway curves exist for a specific distance.

If the curve has a change in horizontal alignment of 135 degrees or more, the Hairpin Curve (W1-11) sign may be used instead of a Curve or Turn sign.

If the curve has a change of direction of approximately 270 degrees, such as on a cloverleaf interchange ramp, the 270-degree Loop (W1-15) sign may be used instead of a Curve or Turn sign.

Guidance:

When the Hairpin Curve sign or the 270-degree Loop sign is installed, either a One-Direction Large Arrow (W1-6) sign or Chevron Alignment (W1-8) signs should be installed on the outside of the turn or curve.

Section 2C.08 Advisory Speed Plaque (W13-1P)

Option:

The Advisory Speed (W13-1P) plaque (see Figure 2C-1) may be used to supplement any warning sign to indicate the advisory speed for a condition.

Standard:

The use of the Advisory Speed plaque for horizontal curves shall be in accordance with the information shown in Table 2C-5. The Advisory Speed plaque shall also be used where an engineering study indicates a need to advise road users of the advisory speed for other roadway conditions.

If used, the Advisory Speed plaque shall carry the message XX MPH. The speed displayed shall be a multiple of 5 mph.

Except in emergencies or when the condition is temporary, an Advisory Speed plaque shall not be installed until the advisory speed has been determined by an engineering study.

Table 2C-5. Horizontal Alignment Sign Selection

Type of Horizontal Alignment Sign	Difference Between Approach Speed * and Advisory Speed				
	5 mph	10 mph	15 mph	20 mph	25 mph or more
Turn (W1-1), Curve (W1-2), Reverse Turn (W1-3), Reverse Curve (W1-4), Winding Road (W1-5), and Combination Horizontal Alignment/Intersection (W1-10 series) (see Section 2C.07 to determine which sign to use)	Recommended	Required	Required	Required	Required
Advisory Speed Plaque (W13-1P)	Recommended	Required	Required	Required	Required
Chevrons (W1-8) and/or One Direction Large Arrow (W1-6)	Optional	Recommended	Required	Required	Required
Exit Speed (W13-2) and Ramp Speed (W13-3) on exit ramp	Optional	Optional	Recommended	Required	Required

*Approach speed means the speed (posted or statutory speed limit, 85th-percentile speed, or prevailing speed) on the approach to the curve (in accordance with FHWA June 2, 2010 letter).

Notes: Required means that the sign and/or plaque shall be used, recommended means that the sign and/or plaque should be used, and optional means that the sign and/or plaque may be used. The speed shown on the advisory speed plaque should be equal or less than the posted or statutory speed limit. However, where the advisory speed is determined to be higher than the posted or statutory speed limit, the advisory speed plaque shall not be used.

See Section 2C.06 for roadways with less than 1,000 AADT.

Figure 2C-2. Example of Warning Signs for a Turn

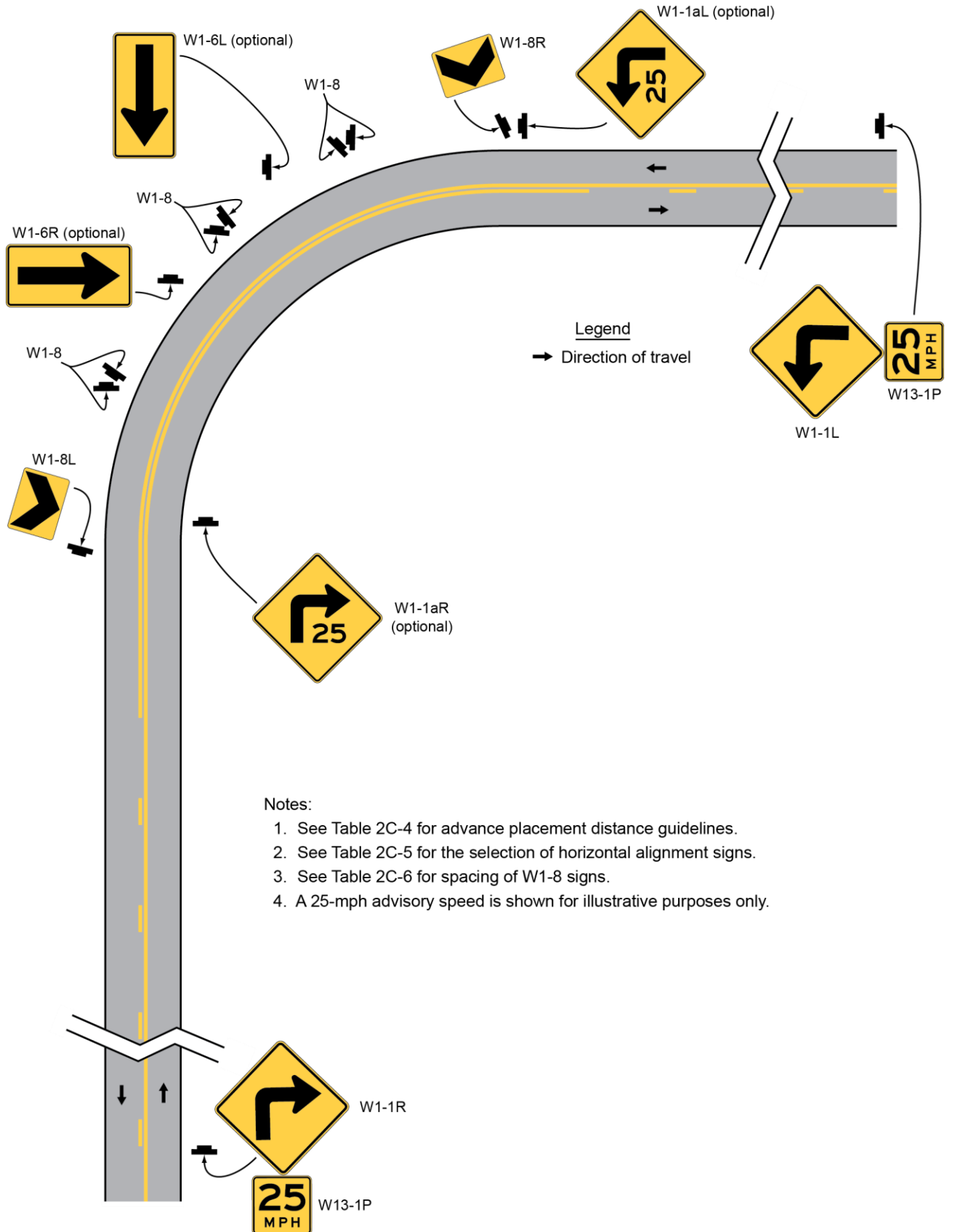

The Advisory Speed plaque shall only be used to supplement a warning sign and shall not be installed as a separate sign installation.

The advisory speed shall be determined by an engineering study that follows established engineering practices.

The speed shown on the advisory speed plaque shall be equal to or less than the posted or statutory speed limit. Where the advisory speed is determined to be higher than the posted or statutory speed limit, the advisory speed plaque shall not be used.

Support:

Among the established engineering practices that are appropriate for the determination of the recommended advisory speed for a horizontal curve are the following:

- A. An accelerometer that provides a direct determination of side friction factors
- B. A design speed equation
- C. A traditional ball-bank indicator using the following criteria:
 1. 16 degrees of ball-bank for speeds of 20 mph or less
 2. 14 degrees of ball-bank for speeds of 25 to 30 mph
 3. 12 degrees of ball-bank for speeds of 35 mph and higher

The 16, 14, and 12 degrees of ball-bank criteria are comparable to the current AASHTO horizontal curve design guidance. Research has shown that drivers often exceed existing posted advisory curve speeds by 7 to 10 mph.

Guidance:

The advisory speed should be determined based on free-flowing traffic conditions.

Because changes in conditions, such as roadway geometrics, surface characteristics, or sight distance, might affect the advisory speed, each location should be evaluated periodically or when conditions change.

Section 2C.09 Chevron Alignment Sign (W1-8)

Standard:

The use of the Chevron Alignment (W1-8) sign (see Figure 2C-1 and Figure 2C-2) to provide additional emphasis and guidance for a change in horizontal alignment shall be in accordance with the information shown in Table 2C-5.

Option:

When used, Chevron Alignment signs may be used instead of or in addition to standard delineators.

Standard:

The Chevron Alignment sign shall be a vertical rectangle. No border shall be used on the Chevron Alignment sign.

If used, Chevron Alignment signs shall be installed on the outside of a turn or curve, in line with and at approximately a right angle to approaching traffic. Chevron Alignment signs shall be installed at a minimum height of 4 feet, measured vertically from the bottom of the sign to the elevation of the near edge of the traveled way.

Guidance:

The approximate spacing of Chevron Alignment signs on the turn or curve measured from the point of curvature (PC) should be as shown in Table 2C-6.

If used, Chevron Alignment signs should be visible for a sufficient distance to provide the road user with adequate time to react to the change in alignment.

Table 2C-6. Typical Spacing of Chevron Alignment Signs on Horizontal Curves

Advisory Speed	Curve Radius	Sign Spacing
15 mph or less	Less than 200 feet	40 feet
20 to 30 mph	200 to 400 feet	80 feet
35 to 45 mph	401 to 700 feet	120 feet
50 to 60 mph	701 to 1,250 feet	160 feet
More than 60 mph	More than 1,250 feet	200 feet

Note: The relationship between the curve radius and the advisory speed shown in this table should not be used to determine the advisory speed.

Standard:

- 07 **Chevron Alignment signs shall not be placed on the far side of a T-intersection facing traffic on the stem approach to warn drivers that a through movement is not physically possible, as this is the function of a Two-Direction (or One-Direction) Large Arrow sign.**
- 08 **Chevron Alignment signs shall not be used to mark obstructions within or adjacent to the roadway, including the beginning of guardrails or barriers, as this is the function of an object marker (see Section 2C.63).**

Section 2C.10 Combination Horizontal Alignment/Advisory Speed Signs (W1-1a, W1-2a)

Option:

- 01 The Turn (W1-1) sign or the Curve (W1-2) sign may be combined with the Advisory Speed (W13-1P) plaque (see Section 2C.08) to create a combination Turn /Advisory Speed (W1-1a) sign or combination Curve/Advisory Speed (W1-2a) sign (see Figure 2C-1).
- 02 The combination Horizontal Alignment/Advisory Speed sign may be used to supplement the advance Horizontal Alignment warning sign and Advisory Speed plaque based upon an engineering study.

Standard:

- 03 **If used, the combination Horizontal Alignment/Advisory Speed sign shall not be used alone and shall not be used as a substitute for a Horizontal Alignment warning sign and Advisory Speed plaque at the advance warning location. The combination Horizontal Alignment/Advisory Speed sign shall only be used as a supplement to the advance Horizontal Alignment warning sign. If used, the combination Horizontal Alignment/Advisory Speed sign shall be installed at the beginning of the turn or curve.**

Guidance:

- 04 *The advisory speed displayed on the combination Horizontal Alignment/Advisory Speed sign should be based on the advisory speed for the horizontal curve using recommended engineering practices (see Section 2C.08).*

Section 2C.11 Combination Horizontal Alignment/Intersection Sign (W1-10 Series)

Option:

- 01 The Turn (W1-1) sign or the Curve (W1-2) sign may be combined with the Cross Road (W2-1) sign or the Side Road (W2-2 or W2-3) sign to create a combination Horizontal Alignment/Intersection (W1-10 series) sign (see Figure 2C-1) that depicts the condition where an intersection occurs within or immediately adjacent to a turn or curve.

Guidance:

- 02 *Elements of the combination Horizontal Alignment/Intersection sign related to horizontal alignment should comply with the provisions of Section 2C.07, and elements related to intersection configuration should comply with the provisions of Section 2C.46. The symbol design should approximate the configuration of the intersecting roadway(s). No more than one Cross Road or two Side Road symbols should be displayed on any one combination Horizontal Alignment/Intersection sign.*

Standard:

- 03 **The use of the combination Horizontal Alignment/Intersection sign shall be in accordance with the appropriate Turn or Curve sign information shown in Table 2C-5.**

Section 2C.12 One-Direction Large Arrow Sign (W1-6)

Option:

- 01 A One-Direction Large Arrow (W1-6) sign (see Figure 2C-1) may be used either as a supplement or alternative to Chevron Alignment signs in order to delineate a change in horizontal alignment (see Figure 2C-2).
- 02 A One-Direction Large Arrow (W1-6) sign may be used on the far side of a T-intersection, facing traffic on the stem approach, to warn drivers that a through movement is not physically possible where the intersected road is for one-way traffic, or where turns are restricted to one direction.

A One-Direction Large Arrow (W1-6) sign may be used to supplement a Turn or Reverse Turn sign (see Figure 2C-2) to emphasize the abrupt curvature.

Standard:

The One-Direction Large Arrow sign shall be a horizontal rectangle with an arrow pointing to the left or right.

The use of the One-Direction Large Arrow sign shall be in accordance with the information shown in Table 2C-5.

If used, the One-Direction Large Arrow sign shall be installed on the outside of a turn or curve in line with and at approximately a right angle to approaching traffic.

The One-Direction Large Arrow sign shall not be used where there is no alignment change in the direction of travel, such as at the beginnings and ends of medians or at center piers.

The One-Direction Large Arrow sign directing traffic to the right shall not be used in the central island of a roundabout.

Guidance:

If used, the One-Direction Large Arrow sign should be visible for a sufficient distance to provide the road user with adequate time to react to the change in alignment.

Support:

See Section 2C.47 for information about the Two-Direction Large Arrow Sign.

Section 2C.13 Truck Rollover Warning Sign (W1-13)

Option:

A Truck Rollover Warning (W1-13) sign (see Figure 2C-1) may be used to warn drivers of vehicles with a high center of gravity, such as trucks, tankers, and recreational vehicles, of a curve or turn where geometric conditions might contribute to a loss of control and a rollover as determined by an engineering study.

Support:

Among the established engineering practices that are appropriate for the determination of the truck rollover potential of a horizontal curve are the following:

- A. An accelerometer that provides a direct determination of side friction factors
- B. A design speed equation
- C. A traditional ball-bank indicator using 10 degrees of ball-bank

Standard:

If a Truck Rollover Warning (W1-13) sign is used, it shall be accompanied by an Advisory Speed (W13-1P) plaque indicating the recommended speed for vehicles with a higher center of gravity.

Option:

The Truck Rollover Warning sign may be displayed as a static sign, as a static sign supplemented by a flashing warning beacon, or as a changeable message sign activated by the detection of an approaching vehicle with a high center of gravity that is traveling in excess of the recommended speed for the condition.

Support:

The curved arrow on the Truck Rollover Warning sign shows the direction of roadway curvature. The truck tips in the opposite direction.

Section 2C.14 Advisory Exit and Ramp Speed Signs (W13-2, W13-3)

Standard:

Advisory Exit Speed (W13-2) and Advisory Ramp Speed (W13-3) signs (see Figure 2C-1) shall be vertical rectangles. The use of Advisory Exit Speed and Advisory Ramp Speed signs of freeway and expressway ramps shall be in accordance with the information shown in Table 2C-5.

Guidance:

If used, the Advisory Exit Speed sign should be installed along the deceleration lane and the advisory speed displayed should be based on an engineering study. When a Truck Rollover (W1-13) sign (see Section

2C.13) is also installed for the ramp, the advisory exit speed should be based on the truck advisory speed for the horizontal alignment using recommended engineering practices.

- 03 *If used, the Advisory Exit Speed sign should be visible in time for the road user to decelerate and make an exiting maneuver.*

Support:

- 04 Table 2C-4 lists recommended advance sign placement distances for deceleration to various advisory speeds.

Guidance:

- 05 *If used, the Advisory Ramp Speed sign should be installed on the ramp to confirm the ramp advisory speed.*
- 06 *If used, Chevron Alignment (W1-8) signs and/or One-Direction Large Arrow (W1-6) signs should be installed on the outside of the exit curve as described in Sections 2C.09 and 2C.12.*

Option:

- 07 Where there is a need to remind road users of the recommended advisory speed, a horizontal alignment warning sign with an advisory speed plaque may be installed at or beyond the beginning of the exit curve or on the outside of the curve, provided that it is apparent that the sign applies only to exiting traffic. These signs may also be used at intermediate points along the ramp, especially if the ramp curvature changes and the subsequent curves on the ramp have a different advisory speed than the initial ramp curve.

Support:

- 08 Figure 2C-3 shows an example of advisory speed signing for an exit ramp.

Section 2C.15 Combination Horizontal Alignment/Advisory Exit and Ramp Speed Signs (W13-6, W13-7)

Option:

- 01 A horizontal alignment sign (see Section 2C.07) may be combined with an Advisory Exit Speed or Advisory Ramp Speed sign to create a combination Horizontal Alignment/Advisory Exit Speed (W13-6) sign or a combination Horizontal Alignment/Advisory Ramp Speed (W13-7) sign (see Figure 2C-1). These combination signs may be used where the severity of the exit ramp curvature might not be apparent to road users in the deceleration lane or where the curvature needs to be specifically identified as being on the exit ramp rather than on the mainline.

Section 2C.16 Hill Signs (W7-1, W7-1a)

Guidance:

- 01 *The Hill (W7-1) sign (see Figure 2C-2) should be used in advance of a downgrade where the length, percent of grade, horizontal curvature, and/or other physical features require special precautions on the part of road users.*
- 02 *The Hill sign and supplemental grade (W7-3P) plaque (see Section 2C.57) used in combination, or the W7-1a sign used alone, should be installed in advance of downgrades for the following conditions:*
- A. *5% grade that is more than 3,000 feet in length;*
 - B. *6% grade that is more than 2,000 feet in length;*
 - C. *7% grade that is more than 1,000 feet in length;*
 - D. *8% grade that is more than 750 feet in length; or*
 - E. *9% grade that is more than 500 feet in length.*
- 03 *These signs should also be installed for steeper grades or where crash experience and field observations indicate a need.*
- 04 *Supplemental plaques (see Section 2C.57) and larger signs should be used for emphasis or where special hill characteristics exist. On longer grades, the use of the Hill sign with a distance (W7-3aP) plaque or the combination distance/grade (W7-3bP) plaque at periodic intervals of approximately 1-mile spacing should be considered.*

Figure 2C-3. Example of Advisory Speed Signing for an Exit Ramp

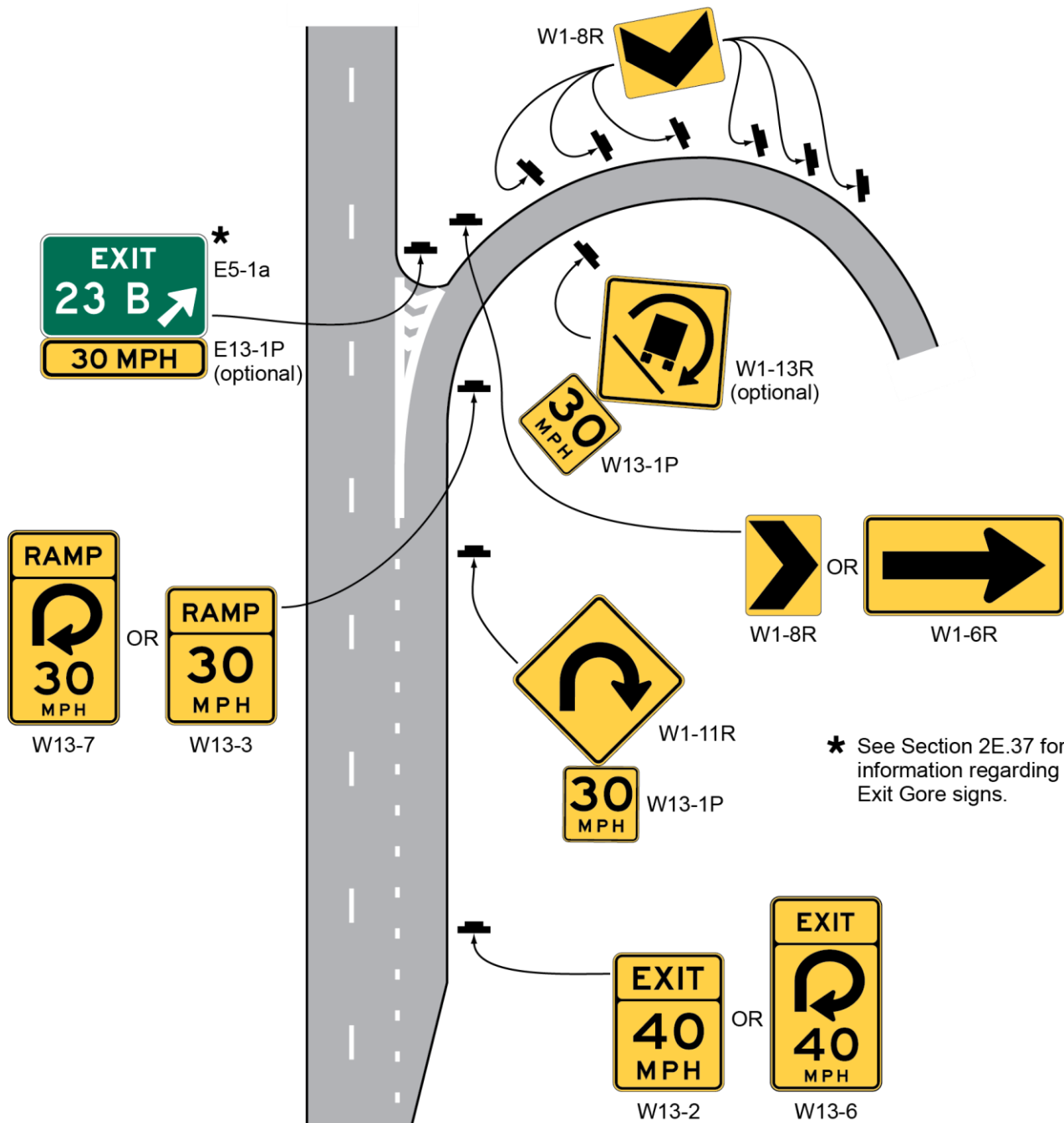

Notes:

1. See Table 2C-4 for advance placement distance guidelines.
2. See Table 2C-5 for the selection of horizontal alignment signs.
3. See Table 2C-6 for spacing of W1-8 signs.
4. A 30-mph ramp advisory speed and 40-mph exit advisory speed are shown for illustrative purposes only.

Figure 2C-4. Vertical Grade Signs and Plaques

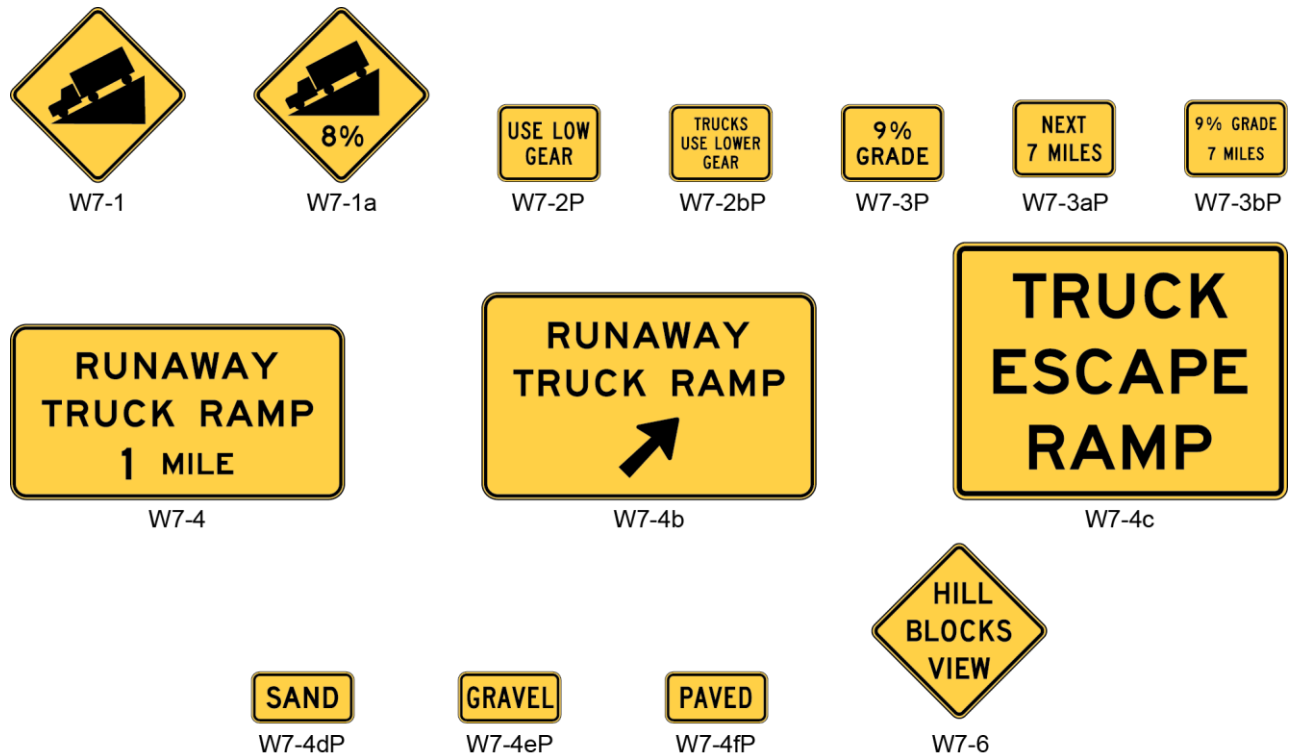
**Standard:**

- 05 If the percent grade is displayed on a supplemental plaque, the plaque shall be placed below the Hill (W7-1) sign.

Option:

- 06 A USE LOW GEAR (W7-2P) or TRUCKS USE LOWER GEAR (W7-2bP) supplemental plaque (see Figure 2C-4) may be used to indicate a situation where downshifting as well as braking might be advisable.

Section 2C.17 Truck Escape Ramp Signs (W7-4 Series)*Guidance:*

- 01 Where applicable, truck escape (or runaway truck) ramp advance warning signs (see Figure 2C-4) should be located approximately 1 mile, and 1/2 mile in advance of the grade, and of the ramp. A sign also should be placed at the gore. A RUNAWAY VEHICLES ONLY (R4-10) sign (see Section 2B.34) should be installed near the ramp entrance to discourage other road users from entering the ramp. No Parking (R8-3) signs should be placed near the ramp entrance.

Standard:

- 02 When truck escape ramps are installed, at least one of the W7-4 series signs shall be used.

Option:

- 03 A SAND (W7-4dP), GRAVEL (W7-4eP), or PAVED (W7-4fP) supplemental plaque (see Figure 2C-4) may be used to describe the ramp surface. Highway agencies may develop appropriate word message signs for the specific situation.

Section 2C.18 HILL BLOCKS VIEW Sign (W7-6)

Option:

- 01 A HILL BLOCKS VIEW (W7-6) sign (see Figure 2C-4) may be used in advance of a crest vertical curve to advise road users to reduce speed as they approach and traverse the hill as only limited stopping sight distance is available.

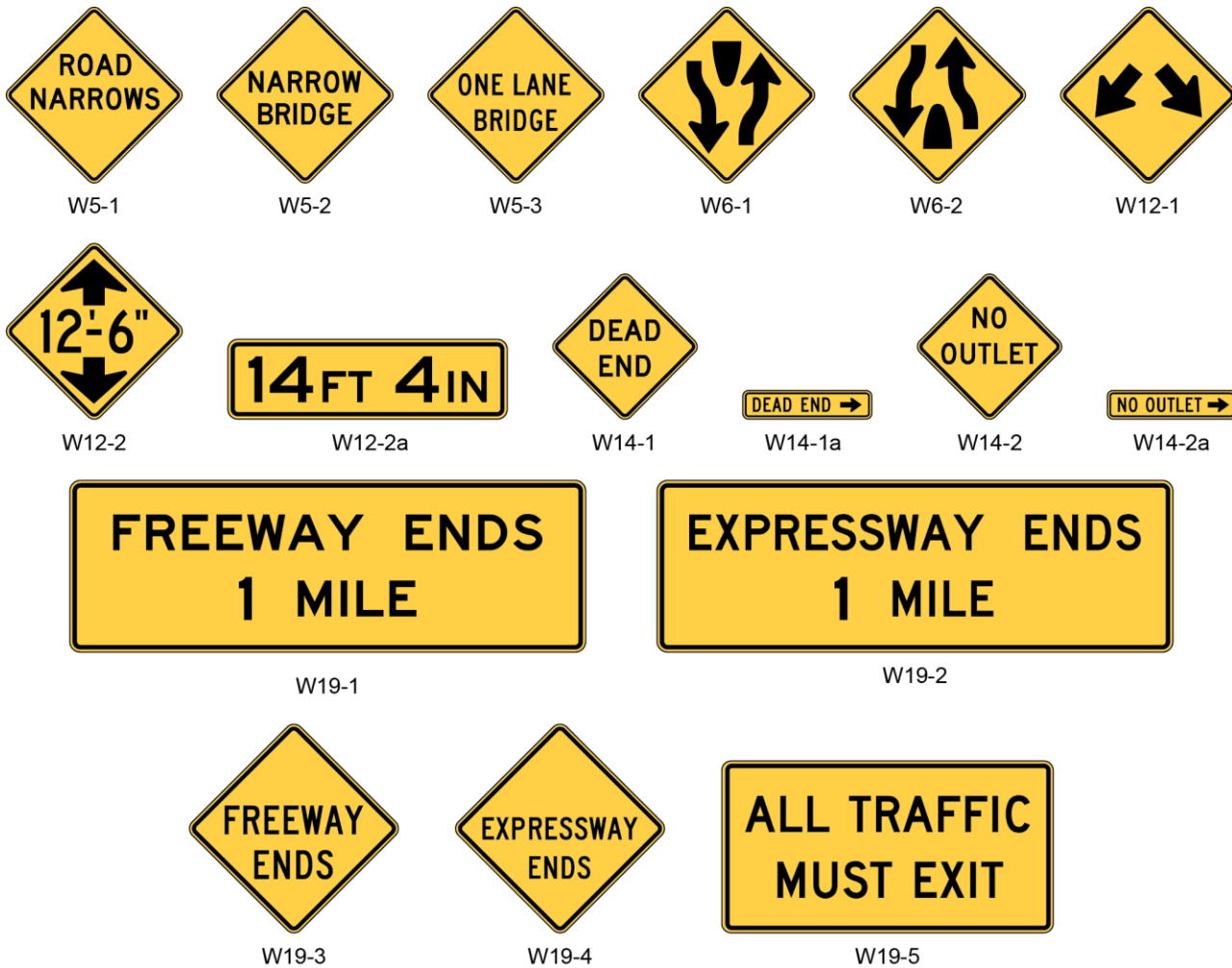
Figure 2C-5. Miscellaneous Warning Signs**Guidance:**

- 02 When a **HILL BLOCKS VIEW** sign is used, it should be supplemented by an **Advisory Speed (W13-1P)** plaque indicating the recommended speed for traveling over the hillcrest based on available stopping sight distance.

Section 2C.19 ROAD NARROWS Sign (W5-1)**Guidance:**

- 01 Except as provided in Paragraph 2, a **ROAD NARROWS (W5-1)** sign (see Figure 2C-5) should be used in advance of a transition on two-lane roads where the pavement width is reduced abruptly to a width such that vehicles traveling in opposite directions cannot simultaneously travel through the narrow portion of the roadway without reducing speed.

Option:

- 02 The **ROAD NARROWS (W5-1)** sign may be omitted on low-volume local streets that have speed limits of 30 mph or less.
- 03 Additional emphasis may be provided by the use of object markers and delineators (see Sections 2C.63 through 2C.65 and Chapter 3F). The **Advisory Speed (W13-1P)** plaque (see Section 2C.08) may be used to indicate the recommended speed.

Section 2C.20 NARROW BRIDGE Sign (W5-2)*Guidance:*

- 01 A **NARROW BRIDGE (W5-2)** sign (see Figure 2C-5) should be used in advance of any bridge or culvert having a two-way roadway clearance width of 16 to 18 feet, or any bridge or culvert having a roadway clearance less than the width of the approach travel lanes.
- 02 Additional emphasis should be provided by the use of object markers, delineators, and/or pavement markings.

Option:

- 03 A **NARROW BRIDGE** sign may be used in advance of a bridge or culvert on which the approach shoulders are narrowed or eliminated.

Section 2C.21 ONE LANE BRIDGE Sign (W5-3)*Guidance:*

- 01 A **ONE LANE BRIDGE (W5-3)** sign (see Figure 2C-5) should be used on two-way roadways in advance of any bridge or culvert:
- A. Having a clear roadway width of less than 16 feet; or
 - B. Having a clear roadway width of less than 18 feet when commercial vehicles constitute a high proportion of the traffic; or
 - C. Having a clear roadway width of 18 feet or less where the sight distance is limited on the approach to the structure.
- 02 Additional emphasis should be provided by the use of object markers, delineators, and/or pavement markings. However, as noted in Section 3B.01, center line markings should not be applied within 150 feet of a one-lane bridge.

Section 2C.22 Divided Highway Sign (W6-1)*Guidance:*

- 01 A **Divided Highway (W6-1)** sign (see Figure 2C-5) should be used on the approaches to a section of highway (not an intersection or junction) where the opposing flows of traffic are separated by a median or other physical barrier.

Standard:

- 02 **The Divided Highway (W6-1) sign shall not be used instead of a Keep Right (R4-7 series) sign on the approach end of a median island.**

Section 2C.23 Divided Highway Ends Sign (W6-2)*Guidance:*

- 01 A **Divided Highway Ends (W6-2)** sign (see Figure 2C-5) should be used in advance of the end of a section of physically divided highway (not an intersection or junction) as a warning of two-way traffic ahead.
- 02 The **Two-Way Traffic (W6-3)** sign (see Section 2C.44) should be used to give warning and notice of the transition to a two-lane, two-way section.

Section 2C.24 Freeway or Expressway Ends Signs (W19 Series)*Option:*

- 01 A **FREEWAY ENDS XX MILES (W19-1)** sign or a **FREEWAY ENDS (W19-3)** sign (see Figure 2C-5) may be used in advance of the end of a freeway.
- 02 An **EXPRESSWAY ENDS XX MILES (W19-2)** sign or an **EXPRESSWAY ENDS (W19-4)** sign (see Figure 2C-5) may be used in advance of the end of an expressway.
- 03 The rectangular W19-1 and W19-2 signs may be post-mounted or may be mounted overhead for increased emphasis.

Guidance:

- 04 *If the reason that the freeway is ending is that the next portion of the freeway is not yet constructed and as a result all traffic must use an exit ramp to leave the freeway, an ALL TRAFFIC MUST EXIT (W19-5) sign (see Figure 2C-5) should be used in addition to the Freeway Ends signs in advance of the downstream end of the freeway.*

Section 2C.25 Double Arrow Sign (W12-1)*Option:*

- 01 The Double Arrow (W12-1) sign (see Figure 2C-5) may be used to advise road users that traffic is permitted to pass on either side of an island, obstruction, or gore in the roadway. Traffic separated by this sign may either rejoin or change directions.

Guidance:

- 02 *If used on an island, the Double Arrow sign should be mounted near the approach end.*
- 03 *If used in front of a pier or obstruction, the Double Arrow sign should be mounted on the face of, or just in front of, the obstruction. Where stripe markings are used on the obstruction, they should be discontinued to leave a 3-inch space around the outside of the sign.*

Section 2C.26 DEAD END/NO OUTLET Signs (W14-1, W14-1a, W14-2, W14-2a)*Option:*

- 01 The DEAD END (W14-1) sign (see Figure 2C-5) may be used at the entrance of a single road or street that terminates in a dead end or cul-de-sac. The NO OUTLET (W14-2) sign (see Figure 2C-5) may be used at the entrance to a road or road network from which there is no other exit.

- 02 The DEAD END (W14-1a) or NO OUTLET (W14-2a) signs (see Figure 2C-5) may be used in combination with the Street Name (D3-1) signs (see Section 2D.43) to warn turning traffic that the cross street ends in the direction indicated by the arrow.

- 03 At locations where the cross street does not have a name, the W14-1a or W14-2a signs may be used alone in place of a street name sign.

Standard:

- 04 **The DEAD END (W14-1a) and NO OUTLET (W14-2a) signs shall be horizontal rectangles with an arrow pointing to the left or right.**

- 05 **When the W14-1 or W14-2 sign is used, the sign shall be posted as near as practical to the entry point or at a sufficient advance distance to permit the road user to avoid the dead end or no outlet condition by turning at the nearest intersecting street.**

- 06 **The DEAD END (W14-1a) and NO OUTLET (W14-2a) signs shall not be used instead of the W14-1 and W14-2 signs where traffic can proceed straight through the intersection into the dead end street or no outlet area.**

Section 2C.27 Low Clearance Signs (W12-2, W12-2a)**Standard:**

- 01 **The Low Clearance (W12-2) sign (see Figure 2C-5) shall be used to warn road users of clearances less than 12 inches above the statutory maximum vehicle height.**

Guidance:

- 02 *The actual clearance should be displayed on the Low Clearance sign to the nearest 1 inch not exceeding the actual clearance. However, in areas that experience changes in temperature causing frost action, a reduction, not exceeding 3 inches, should be used for this condition.*

- 03 *Where the clearance is less than the legal maximum vehicle height, the W12-2 sign with a supplemental distance plaque should be placed at the nearest intersecting road or wide point in the road at which a vehicle can detour or turn around.*

- 04 *In the case of an arch or other structure under which the clearance varies greatly, two or more signs should be used as necessary on the structure itself to give information as to the clearances over the entire roadway.*

Figure 2C-6. Roadway and Weather Condition and Advance Traffic Control Signs and Plaques

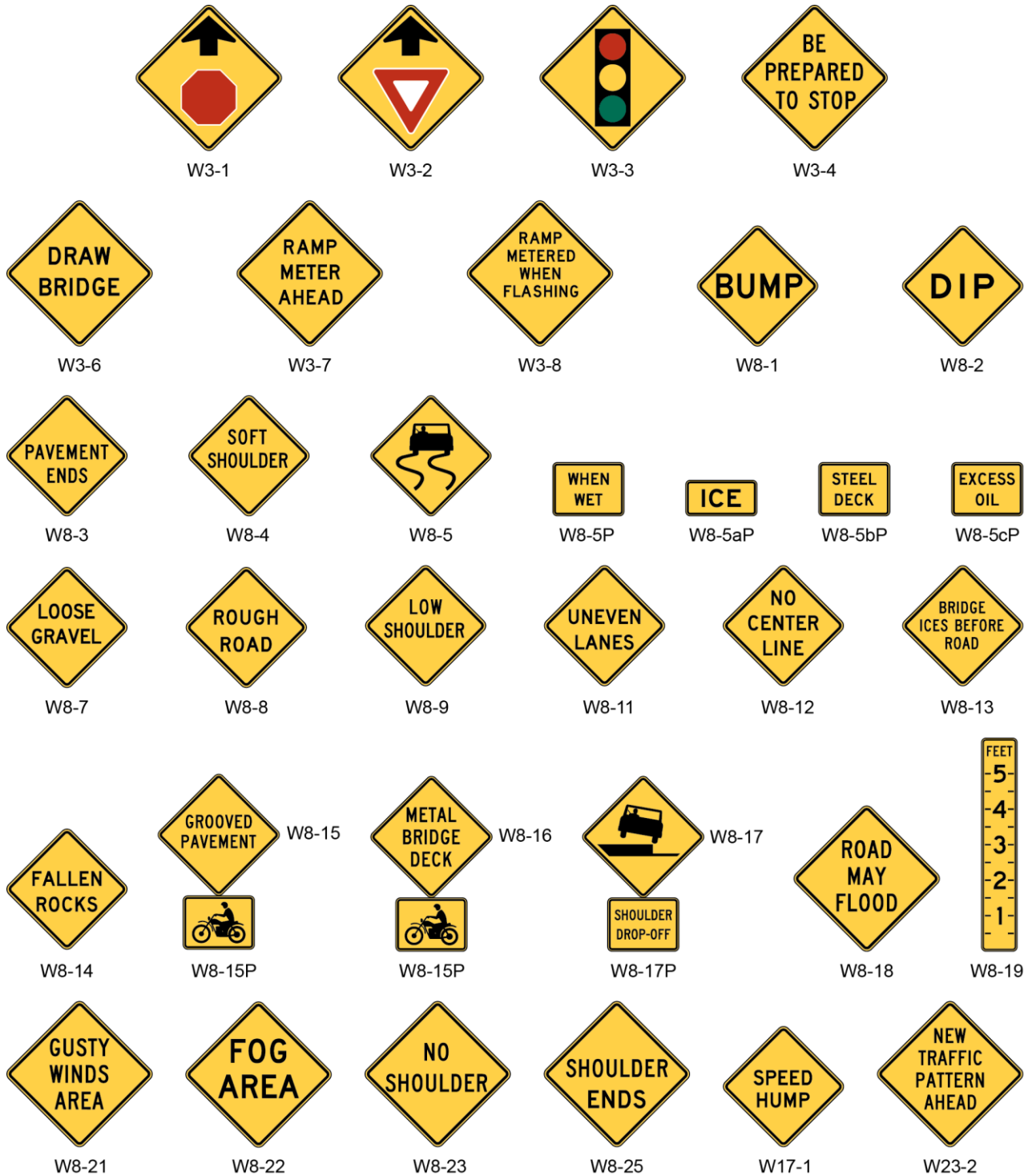

Clearances should be evaluated periodically, particularly when resurfacing operations have occurred.

Option:

The Low Clearance sign may be installed on or in advance of the structure. If a sign is placed on the structure, it may be a rectangular shape (W12-2a) with the appropriate legend (see Figure 2C-5).

Section 2C.28 BUMP and DIP Signs (W8-1, W8-2)

Guidance:

BUMP (W8-1) and DIP (W8-2) signs (see Figure 2C-6) should be used to give warning of a sharp rise or depression in the profile of the road.

Option:

These signs may be supplemented with an Advisory Speed plaque (see Section 2C.08).

Standard:

The DIP sign shall not be used at a short stretch of depressed alignment that might momentarily hide a vehicle.

Guidance:

A short stretch of depressed alignment that might momentarily hide a vehicle should be treated as a no-passing zone when center line striping is provided on a two-lane or three-lane road (see Section 3B.02).

Section 2C.29 SPEED HUMP Sign (W17-1)

Guidance:

The SPEED HUMP (W17-1) sign (see Figure 2C-6) should be used to give warning of a vertical deflection in the roadway that is designed to limit the speed of traffic.

If used, the SPEED HUMP sign should be supplemented by an Advisory Speed plaque (see Section 2C.08).

Option:

If a series of speed humps exists in close proximity, an Advisory Speed plaque may be eliminated on all but the first SPEED HUMP sign in the series.

The legend SPEED BUMP may be used instead of the legend SPEED HUMP on the W17-1 sign.

Support:

Speed humps generally provide more gradual vertical deflection than speed bumps. Speed bumps limit the speed of traffic more severely than speed humps. Other forms of speed humps include speed tables and raised intersections. However, these differences in engineering terminology are not well known by the public, so for signing purposes the terms “speed hump” and “speed bump” are interchangeable

Section 2C.30 PAVEMENT ENDS Sign (W8-3)

Guidance:

A PAVEMENT ENDS (W8-3) word message sign (see Figure 2C-6) should be used where a paved surface changes to either a gravel treated surface or an earth road surface.

Option:

An Advisory Speed plaque (see Section 2C.08) may be used when the change in roadway condition requires a reduced speed.

Section 2C.31 Shoulder Signs (W8-4, W8-9, W8-17, W8-23, W8-25)

Option:

The SOFT SHOULDER (W8-4) sign (see Figure 2C-6) may be used to warn of a soft shoulder condition.

The LOW SHOULDER (W8-9) sign (see Figure 2C-6) may be used to warn of a shoulder condition where there is an elevation difference of less than 3 inches between the shoulder and the travel lane.

Guidance:

- 03 The **SHOULDER DROP OFF (W8-17)** sign (see Figure 2C-6) should be used where an unprotected shoulder drop-off, adjacent to the travel lane, exceeds 3 inches in depth for a significant continuous length along the roadway, based on engineering judgment.

Option:

- 04 A **SHOULDER DROP-OFF (W8-17P)** supplemental plaque (see Figure 2C-6) may be mounted below the W8-17 sign.
- 05 The **NO SHOULDER (W8-23)** sign (see Figure 2C-6) may be used to warn road users that a shoulder does not exist along a portion of the roadway.
- 06 The **SHOULDER ENDS (W8-25)** sign (see Figure 2C-6) may be used to warn road users that a shoulder is ending.

Standard:

- 07 **When used, shoulder signs shall be placed in advance of the condition (see Table 2C-4).**

Guidance:

- 08 *Additional shoulder signs should be placed at appropriate intervals along the road where the condition continually exists.*

Section 2C.32 Surface Condition Signs (W8-5, W8-7, W8-8, W8-11, W8-13, W8-14)*Option:*

- 01 The **Slippery When Wet (W8-5)** sign (see Figure 2C-6) may be used to warn of unexpected slippery condition. Supplemental plaques with legends such as **ICE**, **WHEN WET**, **STEEL DECK**, or **EXCESS OIL** may be used with the W8-5 sign to indicate the reason that the slippery conditions might be present.
- 02 The **LOOSE GRAVEL (W8-7)** sign (see Figure 2C-6) may be used to warn of loose gravel on the roadway surface.
- 03 The **ROUGH ROAD (W8-8)** sign (see Figure 2C-6) may be used to warn of a rough roadway surface.
- 04 An **UNEVEN LANES (W8-11)** sign (see Figure 2C-6) may be used to warn of a difference in elevation between travel lanes.
- 05 The **BRIDGE ICES BEFORE ROAD (W8-13)** sign (see Figure 2C-6) may be used in advance of bridges to advise bridge users of winter weather conditions. The **BRIDGE ICES BEFORE ROAD** sign may be removed or covered during seasons of the year when its message is not relevant.
- 06 The **FALLEN ROCKS (W8-14)** sign (see Figure 2C-6) may be used in advance of an area that is adjacent to a hillside, mountain, or cliff where rocks frequently fall onto the roadway.

Guidance:

- 07 *When used, Surface Condition signs should be placed in advance of the beginning of the affected section (see Table 2C-4), and additional signs should be placed at appropriate intervals along the road where the condition exists.*

Section 2C.33 Warning Signs and Plaques for Motorcyclists (W8-15, W8-15P, W8-16)*Support:*

- 01 The signs and plaques described in this Section are intended to give motorcyclists advance notice of surface conditions that might adversely affect their ability to maintain control of their motorcycle under wet or dry conditions. The use of some of the advance surface condition warning signs described in Section 2C.32, such as **Slippery When Wet**, **LOOSE GRAVEL**, or **ROUGH ROAD**, can also be helpful to motorcyclists if those conditions exist.

Option:

- 02 If a portion of a street or highway features a roadway pavement surface that is grooved or textured instead of smooth, such as a grooved skid resistance treatment for a horizontal curve or a brick pavement surface, a **GROOVED PAVEMENT (W8-15)** sign (see Figure 2C-6) may be used to provide advance warning of this condition to motorcyclists, bicyclists, and other road users. Alternate legends such as **TEXTURED PAVEMENT** or **BRICK PAVEMENT** may also be used on the W8-15 sign.

03 If a bridge or a portion of a bridge includes a metal or grated surface, a METAL BRIDGE DECK (W8-16) sign (see Figure 2C-6) may be used to provide advance warning of this condition to motorcyclists, bicyclists, and other road users.

04 A Motorcycle (W8-15P) plaque (see Figure 2C-6) may be mounted below or above a W8-15 or W8-16 sign if the warning is intended to be directed primarily to motorcyclists.

Section 2C.34 NO CENTER LINE and NO EDGE LINE Signs (W8-12, W8-H12a)

Option:

01 The NO CENTER LINE and NO EDGE LINE (W8-12 and W8-H12a) sign (see Figure 2C-6 and Appendix C) may be used to warn of a roadway without center line (edge line) pavement markings. Section 6F.47 discusses the use of these signs in work zone applications.

Section 2C.35 Weather Condition Signs (W8-18, W8-19, W8-21, W8-22)

Option:

01 The ROAD MAY FLOOD (W8-18) sign (see Figure 2C-6) may be used to warn road users that a section of roadway is subject to frequent flooding. A Depth Gauge (W8-19) sign (see Figure 2C-6) may also be installed within a roadway section that frequently floods.

Standard:

02 **If used, the Depth Gauge sign shall be in addition to the ROAD MAY FLOOD sign and shall indicate the depth of the water at the deepest point on the roadway.**

Option:

03 The GUSTY WINDS AREA (W8-21) sign (see Figure 2C-6) may be used to warn road users that wind gusts frequently occur along a section of highway that are strong enough to impact the stability of trucks, recreational vehicles, and other vehicles with high centers of gravity. A NEXT XX MILES (W7-3aP) supplemental plaque may be mounted below the W8-21 sign to inform road users of the length of roadway that frequently experiences strong wind gusts.

04 The FOG AREA (W8-22) sign (see Figure 2C-6) may be used to warn road users that foggy conditions frequently reduce visibility along a section of highway. A NEXT XX MILES (W7-3aP) supplemental plaque may be mounted below the W8-22 sign to inform road users of the length of roadway that frequently experiences foggy conditions.

Section 2C.36 Advance Traffic Control Signs (W3-1, W3-2, W3-3, W3-4)

Standard:

01 **The Advance Traffic Control symbol signs (see Figure 2C-6) include the Stop Ahead (W3-1), Yield Ahead (W3-2), and Signal Ahead (W3-3) signs. These signs shall be installed on an approach to a primary traffic control device that is not visible for a sufficient distance to permit the road user to respond to the device (see Table 2C-4). The visibility criteria for a traffic control signal shall be based on having a continuous view of at least two signal faces for the distance specified in Table 4D-2.**

Support:

02 Figure 2A-4 shows the typical placement of an Advance Traffic Control sign.

03 Permanent obstructions causing the limited visibility might include roadway alignment or structures. Intermittent obstructions might include foliage or parked vehicles.

Guidance:

04 *Where intermittent obstructions occur, engineering judgment should determine the treatment to be implemented.*

Option:

05 An Advance Traffic Control sign may be used for additional emphasis of the primary traffic control device, even when the visibility distance to the device is satisfactory.

06 An advance street name plaque (see Section 2C.58) may be installed above or below an Advance Traffic Control sign.

07 A warning beacon may be used with an Advance Traffic Control sign.

- 08 A BE PREPARED TO STOP (W3-4) sign (see Figure 2C-6) may be used to warn of stopped traffic caused by a traffic control signal or in advance of a section of roadway that regularly experiences traffic congestion.

Standard:

- 09 **When a BE PREPARED TO STOP sign is used in advance of a traffic control signal, it shall be used in addition to a Signal Ahead sign and shall be placed downstream from the Signal Ahead (3-3) sign.**

Option:

- 10 The BE PREPARED TO STOP sign may be supplemented with a warning beacon (see Section 4L.03).

Guidance:

- 11 *When the warning beacon is interconnected with a traffic control signal or queue detection system, the BE PREPARED TO STOP sign should be supplemented with a WHEN FLASHING (W16-13P) plaque (see Figure 2C-12).*

Support:

- 12 Section 2C.40 contains information regarding the use of a NO MERGE AREA (W4-5P) supplemental plaque in conjunction with a Yield Ahead sign.

Section 2C.37 Advance Ramp Control Signal Signs (W3-7, W3-8)

Option:

- 01 A RAMP METER AHEAD (W3-7) sign (see Figure 2C-6) may be used to warn road users that a freeway entrance ramp is metered and that they will encounter a ramp control signal (see Chapter 4I).

Guidance:

- 02 *When the ramp control signals are operated only during certain periods of the day, a RAMP METERED WHEN FLASHING (W3-8) sign (see Figure 2C-6) should be installed in advance of the ramp control signal near the entrance to the ramp, or on the arterial on the approach to the ramp, to alert road users to the presence and operation of ramp meters.*

Standard:

- 03 **The RAMP METERED WHEN FLASHING sign shall be supplemented with a warning beacon (see Section 4L.03) that flashes when the ramp control signal is in operation.**

Section 2C.38 Reduced Speed Limit Ahead Signs (W3-5, W3-5a)

Guidance:

- 01 *A Reduced Speed Limit Ahead (W3-5 or W3-5a) sign (see Figure 2C-7) should be used to inform road users of a reduced speed zone where the speed limit is being reduced by more than 10 mph, or where engineering judgment indicates the need for advance notice to comply with the posted speed limit ahead.*

Standard:

- 02 **If used, Reduced Speed Limit Ahead signs shall be followed by a Speed Limit (R2-1) sign installed at the beginning of the zone where the speed limit applies.**

- 03 **The speed limit displayed on the Reduced Speed Limit Ahead sign shall be identical to the speed limit displayed on the subsequent Speed Limit sign.**

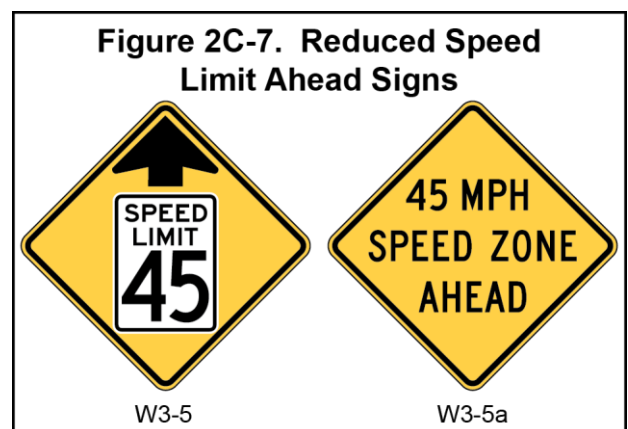

Section 2C.39 DRAW BRIDGE Sign (W3-6)

Standard:

01 A DRAW BRIDGE (W3-6) sign (see Figure 2C-6) shall be used in advance of movable bridge signals and gates (see Section 4J.02) to give warning to road users, except in urban conditions where such signing would not be practical.

Section 2C.40 Merge Signs (W4-1, W4-5)

Option:

01 A Merge (W4-1) sign (see Figure 2C-8) may be used to warn road users on the major roadway that merging movements might be encountered in advance of a point where lanes from two separate roadways converge as a single traffic lane and no turning conflict occurs.

02 A Merge sign may also be installed on the side of the entering roadway to warn road users on the entering roadway of the merge condition.

Guidance:

03 *The Merge sign should be installed on the side of the major roadway where merging traffic will be encountered and in such a position as to not obstruct the road user's view of entering traffic.*

04 *Where two roadways of approximately equal importance converge, a Merge sign should be placed on each roadway.*

05 *When a Merge sign is to be installed on an entering roadway that curves before merging with the major roadway, such as a ramp with a curving horizontal alignment as it approaches the major roadway, the Entering Roadway Merge (W4-5) sign (see Figure 2C-8) should be used to better portray the actual geometric conditions to road users on the entering roadway.*

06 *The Merge sign should not be used where two roadways converge and merging movements are not required.*

07 *The Merge sign should not be used in place of a Lane Ends sign where lanes of traffic moving on a single roadway must merge because of a reduction in the actual or usable pavement width.*

Option:

08 An Entering Roadway Merge (W4-5) sign with a NO MERGE AREA (W4-5P) supplemental plaque mounted below it may be used to warn road users on an entering roadway that they will encounter an abrupt merging situation without an acceleration lane at the downstream end of the ramp.

Figure 2C-8. Merging and Passing Signs and Plaques



- 09 A Merge (W4-1) sign with a NO MERGE AREA (W4-5P) supplemental plaque mounted below it may be used to warn road users on the major roadway that traffic on an entering roadway will encounter an abrupt merging situation without an acceleration lane at the downstream end of the ramp.
- 10 For a yield-controlled channelized right-turn movement onto a roadway without an acceleration lane, a NO MERGE AREA (W4-5P) supplemental plaque may be mounted below a Yield Ahead (W3-2) sign and/or below a YIELD (R1-2) sign when engineering judgment indicates that road users would expect an acceleration lane to be present.

Section 2C.41 Added Lane Signs (W4-3, W4-6)

Guidance:

- 01 *The Added Lane (W4-3) sign (see Figure 2C-8) should be installed in advance of a point where two roadways converge and merging movements are not required. When possible, the Added Lane sign should be placed such that it is visible from both roadways; if this is not possible, an Added Lane sign should be placed on the side of each roadway.*
- 02 *When an Added Lane sign is to be installed on a roadway that curves before converging with another roadway that has a tangent alignment at the point of convergence, the Entering Roadway Added Lane (W4-6) sign (see Figure 2C-8) should be used to better portray the actual geometric conditions to road users on the curving roadway.*

Section 2C.42 Lane Ends Signs (W4-2, W9-1, W9-2)

Guidance:

- 01 *The LANE ENDS MERGE LEFT (RIGHT) (W9-2) sign or the Lane Ends (W4-2) sign should be used to warn of the reduction in the number of traffic lanes in the direction of travel on a multi-lane highway (see Figure 2C-8).*

Option:

- 02 *The RIGHT (LEFT) LANE ENDS (W9-1) sign (see Figure 2C-8) may be used in advance of the Lane Ends (W4-2) sign or the LANE ENDS MERGE LEFT (RIGHT) (W9-2) sign as additional warning or to emphasize that the traffic lane is ending and that a merging maneuver will be required.*

Guidance:

- 03 *If used, the RIGHT (LEFT) LANE ENDS (W9-1) sign should be installed adjacent to the Lane-Reduction Arrow pavement markings.*

Option:

- 04 *On one-way streets or on divided highways where the width of the median will permit, two Lane Ends signs may be placed facing approaching traffic, one on the right-hand side and the other on the left-hand side or median.*

Support:

- 05 *Section 3B.09 contains information regarding the use of pavement markings in conjunction with a lane reduction.*

Guidance:

- 06 *Where an extra lane has been provided for slower moving traffic (see Section 2B.31), a Lane Ends word sign or a Lane Ends (W4-2) symbol sign should be installed in advance of the downstream end of the extra lane.*
- 07 *Lane Ends signs should not be installed in advance of the downstream end of an acceleration lane.*

Standard:

- 08 **In dropped lane situations, regulatory signs (see Section 2B.20) shall be used to inform road users that a through lane is becoming a mandatory turn lane. The W4-2, W9-1, and W9-2 signs shall not be used in dropped lane situations.**

Section 2C.43 RIGHT (LEFT) LANE EXIT ONLY AHEAD Sign (W9-7)**Option:**

- 01 The RIGHT (LEFT) LANE EXIT ONLY AHEAD (W9-7) sign (see Figure 2C-8) may be used to provide advance warning to road users that traffic in the right-hand (left-hand) lane of a roadway that is approaching a grade-separated interchange will be required to depart the roadway on an exit ramp at the next interchange.

Standard:

- 02 **The W9-7 sign shall be a horizontal rectangle with a black legend and border on a yellow background.**

Guidance:

- 03 *If used, the W9-7 sign should be installed upstream from the first overhead guide sign that contains an EXIT ONLY sign panel or upstream from the first RIGHT (LEFT) LANE MUST EXIT (R3-33) regulatory sign, whichever is farther upstream from the exit.*

Support:

- 04 Section 2B.23 contains information regarding a regulatory sign that can also be used for lane drops at grade-separated interchanges.

Section 2C.44 Two-Way Traffic Sign (W6-3)**Guidance:**

- 01 *A Two-Way Traffic (W6-3) sign (see Figure 2C-8) should be used to warn road users of a transition from a multi-lane divided section of roadway to a two-lane, two-way section of roadway.*
- 02 *A Two-Way Traffic (W6-3) sign with an AHEAD (W16-9P) plaque (see Figure 2C-12) should be used to warn road users of a transition from a one-way street to a two-lane, two-way section of roadway (see Figure 2B-14).*

Option:

- 03 The Two-Way Traffic sign may be used at intervals along a two-lane, two-way roadway and may be used to supplement the Divided Highway Ends (W6-2) sign discussed in Section 2C.23.

Section 2C.45 NO PASSING ZONE Sign (W14-3)**Standard:**

- 01 **The NO PASSING ZONE (W14-3) sign (see Figure 2C-8) shall be a pennant-shaped isosceles triangle with its longer axis horizontal and pointing to the right. When used, the NO PASSING ZONE sign shall be installed on the left side of the roadway at the beginning of no-passing zones identified by pavement markings or DO NOT PASS signs or both (see Sections 2B.28 and 3B.02).**

Section 2C.46 Intersection Warning Signs (W2-1 through W2-8)**Option:**

- 01 A Cross Road (W2-1) symbol, Side Road (W2-2 or W2-3) symbol, T-Symbol (W2-4), or Y-Symbol (W2-5) sign (see Figure 2C-9) may be used in advance of an intersection to indicate the presence of an intersection and the possibility of turning or entering traffic.

- 02 The Circular Intersection (W2-6) symbol sign (see Figure 2C-9) may be installed in advance of a circular intersection (see Figures 2B-21 through 2B-23).

Guidance:

- 03 *If an approach to a roundabout has a statutory or posted speed limit of 40 mph or higher, the Circular Intersection (W2-6) symbol sign should be installed in advance of the circular intersection.*

Option:

- 04 An educational plaque (see Figure 2C-9) with a legend such as ROUNDABOUT (W16-17P) or TRAFFIC CIRCLE (W16-12P) may be mounted below a Circular Intersection symbol sign.

- 05 The relative importance of the intersecting roadways may be shown by different widths of lines in the symbol.

Figure 2C-9. Intersection Warning Signs and Plaques

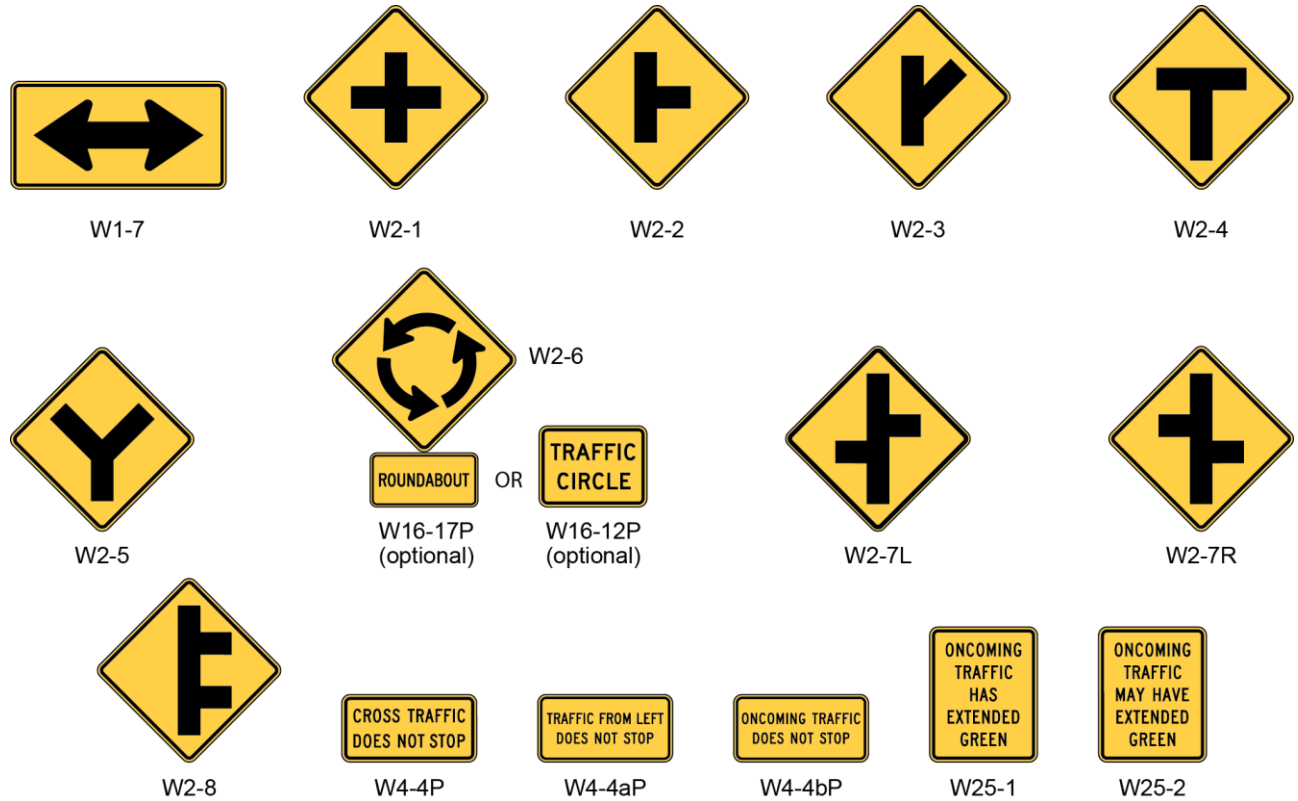

06 An advance street name plaque (see Section 2C.58) may be installed above or below an Intersection Warning sign.

Guidance:

07 *The Intersection Warning sign should illustrate and depict the general configuration of the intersecting roadway, such as cross road, side road, T-intersection, or Y-intersection.*

08 *Intersection Warning signs, other than the Circular Intersection symbol (W2-6) sign and the T-intersection symbol (W2-4) sign should not be used on approaches controlled by STOP signs, YIELD signs, or signals.*

09 *If an Intersection Warning sign is used where the side roads are not opposite of each other, the Offset Side Roads (W2-7) symbol sign (see Figure 2C-9) should be used instead of the Cross Road symbol sign.*

10 *If an Intersection Warning sign is used where two closely-spaced side roads are on the same side of the highway, the Double Side Roads (W2-8) symbol sign (see Figure 2C-9) should be used instead of the Side Road symbol sign.*

11 *No more than two side road symbols should be displayed on the same side of the highway on a W2-7 or W2-8 symbol sign, and no more than three side road symbols should be displayed on a W2-7 or W2-8 symbol sign.*

Support:

12 Figure 2A-4 shows the typical placement of an Intersection Warning sign.

Section 2C.47 Two-Direction Large Arrow Sign (W1-7)

Standard:

01 **The Two-Direction Large Arrow (W1-7) sign (see Figure 2C-9) shall be a horizontal rectangle.**

02 **If used, it shall be installed on the far side of a T-intersection in line with, and at approximately a right angle to, traffic approaching from the stem of the T-intersection.**

The Two-Direction Large Arrow sign shall not be used where there is no change in the direction of travel such as at the beginnings and ends of medians or at center piers.

The Two-Direction Large Arrow sign directing traffic to the left and right shall not be used in the central island of a roundabout.

Guidance:

The Two-Direction Large Arrow sign should be visible for a sufficient distance to provide the road user with adequate time to react to the intersection configuration.

Section 2C.48 Traffic Signal Signs (W25-1, W25-2)

Standard:

At locations where either a W25-1 or a W25-2 sign is required based on the provisions in Section 4D.05, the W25-1 or W25-2 sign (see Figure 2C-9) shall be installed near the left-most signal head. The W25-1 and W25-2 signs shall be vertical rectangles.

Section 2C.49 Vehicular Traffic Warning Signs (W8-6, W11-1, W11-5, W11-5a, W11-8, W11-10, W11-11, W11-12P, W11-14, W11-15, W11-15a)

Option:

Vehicular Traffic Warning (W8-6, W11-1, W11-5, W11-5a, W11-8, W11-10, W11-11, W11-12P, W11-14, W11-15, and W11-15a) signs (see Figure 2C-10) may be used to alert road users to locations where unexpected entries into the roadway by trucks, bicyclists, farm vehicles, emergency vehicles, golf carts, horse-drawn vehicles, or other vehicles might occur. The TRUCK CROSSING (W8-6) word message sign may be used as an alternate to the Truck Crossing symbol (W11-10) sign.

Support:

These locations might be relatively confined or might occur randomly over a segment of roadway.

Guidance:

Vehicular Traffic Warning signs should be used only at locations where the road user's sight distance is restricted, or the condition, activity, or entering traffic would be unexpected.

If the condition or activity is seasonal or temporary, the Vehicular Traffic Warning sign should be removed or covered when the condition or activity does not exist.

Option:

The combined Bicycle/Pedestrian (W11-15) sign may be used where both bicyclists and pedestrians might be crossing the roadway, such as at an intersection with a shared-use path. A TRAIL X-ING (W11-15P) supplemental plaque (see Figure 2C-10) may be mounted below the W11-15 sign. The TRAIL CROSSING (W11-15a) sign may be used to warn of shared-use path crossings where pedestrians, bicyclists, and other user groups might be crossing the roadway.

The W11-1, W11-15, and W11-15a signs and their related supplemental plaques may have a fluorescent yellow-green background with a black legend and border.

Supplemental plaques (see Section 2C.53) with legends such as AHEAD, XX FEET, NEXT XX MILES, or SHARE THE ROAD may be mounted below Vehicular Traffic Warning signs to provide advance notice to road users of unexpected entries.

Guidance:

If used in advance of a pedestrian and bicycle crossing, a W11-15 or W11-15a sign should be supplemented with an AHEAD or XX FEET plaque to inform road users that they are approaching a point where crossing activity might occur.

Standard:

If a post-mounted W11-1, W11-11, W11-15, or W11-15a sign is placed at the location of the crossing point where golf carts, pedestrians, bicyclists, or other shared-use path users might be crossing the roadway, a diagonal downward pointing arrow (W16-7P) plaque (see Figure 2C-12) shall be mounted below the sign. If the W11-1, W11-11, W11-15, or W11-15a sign is mounted overhead, the W16-7P supplemental plaque shall not be used.

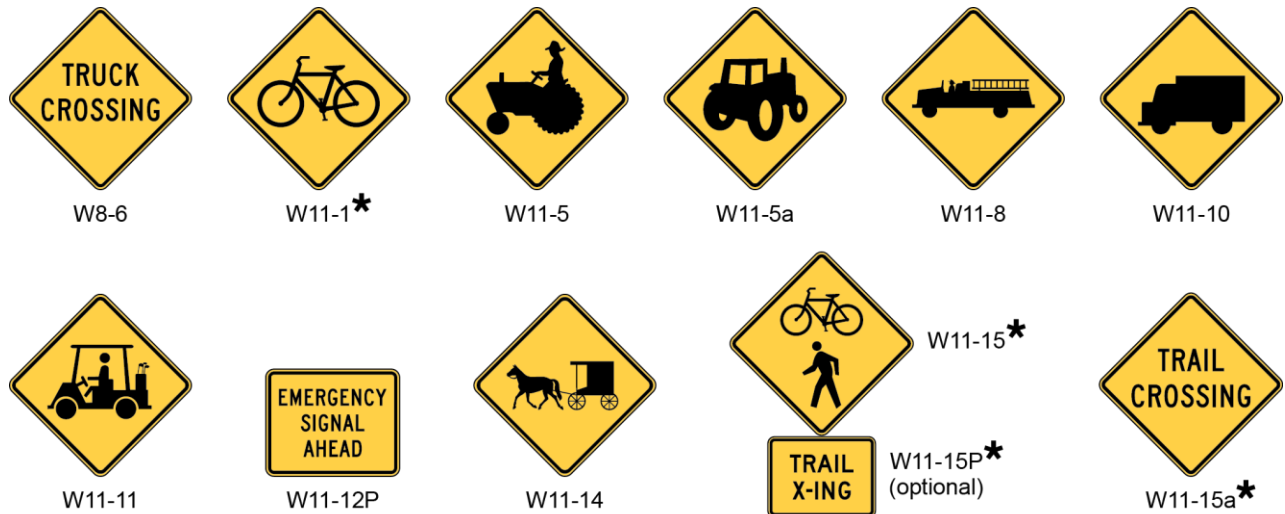
Figure 2C-10. Vehicular Traffic Warning Signs and Plaques

★ A fluorescent yellow-green background color may be used for this sign or plaque.

Option:

- 10 The crossing location identified by a W11-1, W11-11, W11-15, or W11-15a sign may be defined with crosswalk markings (see Section 3B.18).

Standard:

- 11 **The Emergency Vehicle (W11-8) sign (see Figure 2C-10) with the EMERGENCY SIGNAL AHEAD (W11-12P) supplemental plaque (see Figure 2C-10) shall be placed in advance of all emergency-vehicle traffic control signals (see Chapter 4G).**

Option:

- 12 The Emergency Vehicle (W11-8) sign, or a word message sign indicating the type of emergency vehicle (such as rescue squad), may be used in advance of the emergency vehicle station when no emergency-vehicle traffic control signal is present.
- 13 A Warning Beacon (see Section 4L.03) may be used with any Vehicular Traffic Warning sign to indicate specific periods when the condition or activity is present or is likely to be present, or to provide enhanced sign conspicuity.
- 14 A supplemental WHEN FLASHING (W16-13P) plaque (see Figure 2C-12) may be used with any Vehicular Traffic Warning sign that is supplemented with a Warning Beacon to indicate specific periods when the condition or activity is present or is likely to be present.

Section 2C. 50 Non-Vehicular Warning Signs (W11-2, W11-3, W11-4, W11-6, W11-7, W11-9, and W11-16 through W11-22)

Option:

- 01 Non-Vehicular Warning (W11-2, W11-3, W11-4, W11-6, W11-7, W11-9, and W11-16 through W11-22) signs (see Figure 2C-11) may be used to alert road users in advance of locations where unexpected entries into the roadway might occur or where shared use of the roadway by pedestrians, animals, or equestrians might occur.

Support:

- 02 These conflicts might be relatively confined, or might occur randomly over a segment of roadway.

Guidance:

- 03 *If used in advance of a pedestrian, snowmobile, or equestrian crossing, the W11-2, W11-6, W11-7, and W11-9 signs should be supplemented with plaques (see Section 2C.55) with the legend AHEAD or XX FEET to inform road users that they are approaching a point where crossing activity might occur.*

Standard:

04 **If a post-mounted W11-2, W11-6, W11-7, or W11-9 sign is placed at the location of the crossing point where pedestrians, snowmobilers, or equestrians might be crossing the roadway, a diagonal downward pointing arrow (W16-7P) plaque (see Figure 2C-12) shall be mounted below the sign. If the W11-2, W11-6, W11-7, or W11-9 sign is mounted overhead, the W16-7P plaque shall not be used.**

Option:

05 A Pedestrian Crossing (W11-2) sign may be placed overhead or may be post-mounted with a diagonal downward pointing arrow (W16-7P) plaque at the crosswalk location where Yield Here To Pedestrians signs (see Section 2B.11) have been installed in advance of the crosswalk.

Standard:

06 **If a W11-2 sign has been post-mounted at the crosswalk location where a Yield Here To Pedestrians sign is used on the approach, the Yield Here To Pedestrians sign shall not be placed on the same post as or block the road user's view of the W11-2 sign.**

Option:

07 An advance Pedestrian Crossing (W11-2) sign with an AHEAD or a distance supplemental plaque may be used in conjunction with a Yield Here To Pedestrians sign on the approach to the same crosswalk.

Option:

08 The crossing location identified by a W11-2, W11-6, W11-7, or W11-9 sign may be defined with crosswalk markings (see Section 3B.18).

09 The W11-2 and W11-9 signs and their related supplemental plaques may have a fluorescent yellow-green background with a black legend and border.

Guidance:

10 *When a fluorescent yellow-green background is used, a systematic approach featuring one background color within a zone or area should be used. The mixing of standard yellow and fluorescent yellow-green backgrounds within a selected site area should be avoided.*

Option:

11 A Warning Beacon (see Section 4L.03) may be used with any Non-Vehicular Warning sign to indicate specific periods when the condition or activity is present or is likely to be present, or to provide enhanced sign conspicuity.

12 A supplemental WHEN FLASHING (W16-13P) plaque (see Figure 2C-12) may be used with any Non-Vehicular Warning sign that is supplemented with a Warning Beacon to indicate specific periods when the condition or activity is present or is likely to be present.

Figure 2C-11. Non-Vehicular Warning Signs

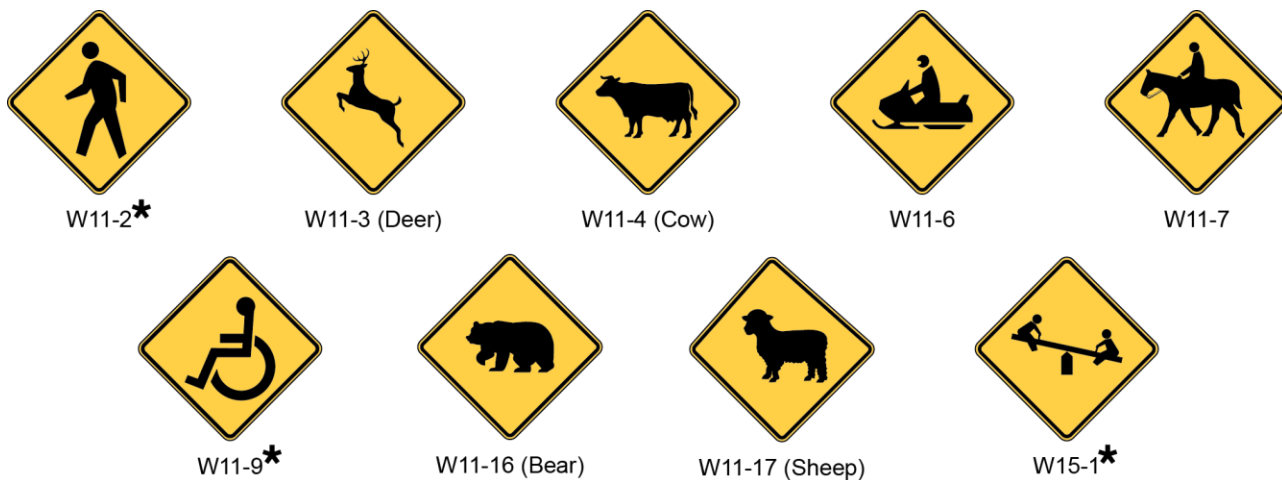

* A fluorescent yellow-green background color may be used for this sign or plaque.

Section 2C.51 Playground Sign (W15-1)

Option:

- 01 The Playground (W15-1) sign (see Figure 2C-11) may be used to give advance warning of a designated children's playground that is located adjacent to the road.
- 02 The Playground sign may have a fluorescent yellow-green background with a black legend and border.

Guidance:

- 03 *If the access to the playground area requires a roadway crossing, the application of crosswalk pavement markings (see Section 3B.18) and Non-Vehicular signs (see Section 2C.50) should be considered.*

Section 2C.52 NEW TRAFFIC PATTERN AHEAD Sign (W23-2)

Option:

- 01 A NEW TRAFFIC PATTERN AHEAD (W23-2) sign (see Figure 2C-6) may be used on the approach to an intersection or along a section of roadway to provide advance warning of a change in traffic patterns, such as revised lane usage, roadway geometry, or signal phasing.

Guidance:

- 02 *The NEW TRAFFIC PATTERN AHEAD sign should be removed when the traffic pattern returns to normal, when the changed pattern is no longer considered to be new, or within six months.*

Section 2C.53 Use of Supplemental Warning Plaques

Option:

- 01 A supplemental warning plaque (see Figure 2C-12) may be displayed with a warning or regulatory sign when engineering judgment indicates that road users require additional warning information beyond that contained in the main message of the warning or regulatory sign.

Standard:

- 02 **Supplemental warning plaques shall be used only in combination with warning or regulatory signs. They shall not be mounted alone or displayed alone. If used, a supplemental plaque shall be installed on the same post(s) as the warning or regulatory sign that it supplements.**
- 03 **Unless otherwise provided in this Manual for a particular plaque, supplemental warning plaques shall be mounted below the sign they supplement.**

Section 2C.54 Design of Supplemental Warning Plaques**Standard:**

- 01 **A supplemental warning plaque used with a warning sign shall have the same legend, border, and background color as the warning sign with which it is displayed. A supplemental warning plaque used with a regulatory sign shall have a black legend and border on a yellow background.**
- 02 **Supplemental warning plaques shall be square or rectangular.**

Section 2C.55 Distance Plaques (W16-2 Series, W16-3 Series, W16-4P, W7-3aP)

Option:

- 01 The Distance Ahead (W16-2 series and W16-3 series) plaques (see Figure 2C-12) may be used to inform the road user of the distance to the condition indicated by the warning sign.
- 02 The Next Distance (W7-3aP and W16-4P) plaques (see Figures 2C-4 and 2C-12) may be used to inform road users of the length of roadway over which the condition indicated by the warning sign exists.

Section 2C.56 Supplemental Arrow Plaques (W16-5P, W16-6P)

Guidance:

- 01 *If the condition indicated by a warning sign is located on an intersecting road and the distance between the intersection and condition is not sufficient to provide adequate advance placement of the warning sign, a Supplemental Arrow (W16-5P or W16-6P) plaque (see Figure 2C-12) should be used below the warning sign.*

Figure 2C-12. Supplemental Warning Plaques

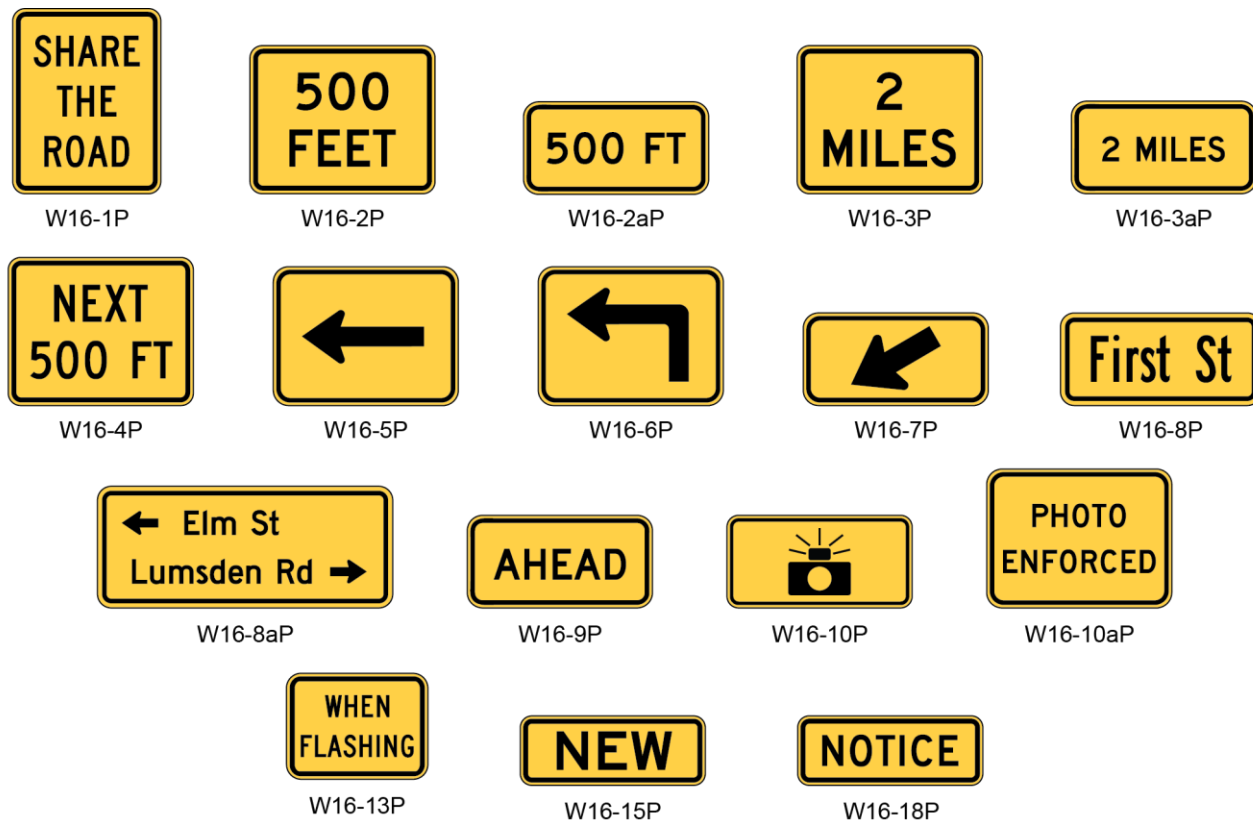

Note: The background color (yellow or fluorescent yellow-green) shall match the color of the warning sign that it supplements.

Standard:

- 02 Supplemental Arrow plaques shall have the same legend design as the Advance Turn Arrow and Directional Arrow auxiliary signs (see Sections 2D.26 and 2D.28) except that they shall have a black legend and border on a yellow or fluorescent yellow-green background, as appropriate.

Section 2C.57 Hill-Related Plaques (W7-2 Series, W7-3 Series)

Guidance:

- 01 Hill-Related (W7-2 series, W7-3 series) plaques (see Figure 2C-4) or other appropriate legends and larger signs should be used for emphasis or where special hill characteristics exist.
- 02 On longer grades, the use of the distance plaque (W7-3aP or W7-3bP) at periodic intervals of approximately 1-mile spacing should be considered.

Section 2C.58 Advance Street Name Plaques (W16-8P, W16-8aP)

Option:

- 01 An Advance Street Name (W16-8P or W16-8aP) plaque (see Figure 2C-12) may be used with any Intersection (W2 series, W10-2, W10-3, or W10-4) sign or Advance Traffic Control (W3 series) sign to identify the name of the intersecting street.

Standard:

- 02 The lettering on Advance Street Name plaques shall be composed of a combination of lower-case letters with initial upper-case letters.
- 03 If two street names are used on the Advance Street Name plaque, a directional arrow pointing in the direction of the street shall be placed next to each street name. Arrows pointing to the left shall be placed to the left of the street name, and arrows pointing to the right shall be placed to the right of the street name.

Guidance:

- 04 *If two street names are used on the Advance Street Name plaque, the street names and associated arrows should be displayed in the following order:*
- A. *For a single intersection, the name of the street to the left should be displayed above the name of the street to the right; or*
 - B. *For two sequential intersections, such as where the plaque is used with an Offset Side Roads (W2-7) or a Double Side Road (W2-8) symbol sign, the name of the first street encountered should be displayed above the name of the second street encountered, and the arrow associated with the second street encountered should be an advance arrow, such as the arrow shown on the W16-6P arrow plaque (see Figure 2C-12).*

Section 2C.59 CROSS TRAFFIC DOES NOT STOP Plaque (W4-4P)*Option:*

- 01 The CROSS TRAFFIC DOES NOT STOP (W4-4P) plaque (see Figure 2C-9) may be used in combination with a STOP sign when engineering judgment indicates that conditions are present that are causing or could cause drivers to misinterpret the intersection as an all-way stop.
- 02 Alternative messages (see Figure 2C-9) such as TRAFFIC FROM LEFT (RIGHT) DOES NOT STOP (W4-4aP) or ONCOMING TRAFFIC DOES NOT STOP (W4-4bP) may be used when such messages more accurately describe the traffic controls established at the intersection.

Guidance:

- 03 *Plaques with the appropriate alternative messages of TRAFFIC FROM LEFT (RIGHT) DOES NOT STOP or ONCOMING TRAFFIC DOES NOT STOP should be used at intersections where STOP signs control all but one approach to the intersection, unless the only non-stopped approach is from a one-way street.*

Standard:

- 04 **If a W4-4P plaque or a plaque with an alternative message is used, it shall be mounted below the STOP sign.**

Section 2C.60 SHARE THE ROAD Plaque (W16-1P)*Option:*

- 01 In situations where there is a need to warn drivers to watch for other slower forms of transportation traveling along the highway, such as bicycles, golf carts, horse-drawn vehicles, or farm machinery, a SHARE THE ROAD (W16-1P) plaque (see Figure 2C-12) may be used. **Standard:**
- 02 **A W16-1P plaque shall not be used alone. If a W16-1P plaque is used, it shall be mounted below either a Vehicular Traffic Warning sign (see Section 2C.49) or a Non-Vehicular Warning sign (see Section 2C.50). The background color of the W16-1P plaque shall match the background color of the warning sign with which it is displayed.**

Section 2C.61 PHOTO ENFORCED Plaque (W16-10P)*Option:*

- 01 A Photo Enforced (W16-10P) plaque or a PHOTO ENFORCED (W16-10aP) word message plaque (see Figure 2C-12) may be mounted below a warning sign to advise road users that the regulations associated with the condition being warned about (such as a traffic control signal or a toll plaza) are being enforced by photographic equipment.

Standard:

- 02 **If used below a warning sign, the PHOTO ENFORCED (W16-10P or W16-10aP) plaque shall be a rectangle with a black legend and border on a yellow background.**

Section 2C.62 NEW Plaque (W16-15P)*Option:*

- 01 A NEW (W16-15P) plaque (see Figure 2C-12) may be mounted above a regulatory sign when a new regulation takes effect in order to alert road users to the new traffic regulation. A NEW plaque may also be

mounted above an advance warning sign (such as a Signal Ahead sign for a newly-installed traffic control signal) for a new traffic regulation.

Standard:

02 **The NEW plaque shall not be used alone.**

03 **The NEW plaque shall be removed no later than 6 months after the regulation has been in effect.**

Section 2C.63 Object Marker Design and Placement Height

Support:

01 Type 1, 2, and 3 object markers are used to mark obstructions within or adjacent to the roadway. Type 4 object markers are used to mark the end of a roadway.

Standard:

02 **When used, object markers (see Figure 2C-13) shall not have a border and shall consist of an arrangement of one or more of the following types:**

Type 1—a diamond-shaped sign, at least 18 inches on a side, consisting of either a yellow (OM1-1) or black (OM1-2) sign with nine yellow retroreflective devices, each with a minimum diameter of 3 inches, mounted symmetrically on the sign, or an all-yellow retroreflective sign (OM1-3).

Type 2—either a marker (OM2-1V or OM2-1H) consisting of three yellow retroreflective devices, each with a minimum diameter of 3 inches, arranged either horizontally or vertically on a white sign measuring at least 6 x 12 inches; or an all-yellow horizontal or vertical retroreflective sign (OM2-2V or OM2-2H), measuring at least 6 x 12 inches.

Type 3—a striped marker, 12 x 36 inches, consisting of a vertical rectangle with alternating black and retroreflective yellow stripes sloping downward at an angle of 45 degrees toward the side of the obstruction on which traffic is to pass. The minimum width of the yellow and black stripes shall be 3 inches.

Type 4—a diamond-shaped sign, at least 18 inches on a side, consisting of either a red (OM4-1) or black (OM4-2) sign with nine red retroreflective devices, each with a minimum diameter of 3 inches, mounted symmetrically on the sign, or an all-red retroreflective sign (OM4-3).

Support:

03 For Type 3 object markers, a better appearance can be achieved if the black stripes are wider than the yellow stripes.

04 Type 3 object markers with stripes that begin at the upper right side and slope downward to the lower left side are designated as right object markers (OM3-R). Object markers with stripes that begin at the upper left side and slope downward to the lower right side are designated as left object markers (OM3-L).

Guidance:

05 *When used for marking obstructions within the roadway or obstructions that are 8 feet or less from the shoulder or curb, the minimum mounting height, measured from the bottom of the object marker to the elevation of the near edge of the traveled way, should be 4 feet.*

06 *When used to mark objects more than 8 feet from the shoulder or curb, the clearance from the ground to the bottom of the object marker should be at least 4 feet.*

07 *Object markers should not present a vertical or horizontal clearance obstacle for pedestrians.*

Option:

08 When object markers or markings are applied to an obstruction that by its nature requires a lower or higher mounting, the vertical mounting height may vary according to need.

Support:

09 Section 9B.26 contains information regarding the use of object markers on shared-use paths.

Section 2C.64 Object Markers for Obstructions Within the Roadway

Standard:

- 01 **Obstructions within the roadway shall be marked with a Type 1 or Type 3 object marker. In addition to markers on the face of the obstruction, warning of approach to the obstruction shall be given by appropriate pavement markings (see Section 3B.10).**

Option:

- 02 To provide additional emphasis, a Type 1 or Type 3 object marker may be installed at or near the approach end of a median island.
- 03 To provide additional emphasis, large surfaces such as bridge piers may be painted with diagonal stripes, 12 inches or greater in width, similar in design to the Type 3 object marker.

Standard:

- 04 **The alternating black and retroreflective yellow stripes (OM3-L, OM3-R) shall be sloped down at an angle of 45 degrees toward the side on which traffic is to pass the obstruction. If traffic can pass to either side of the obstruction, the alternating black and retroreflective yellow stripes (OM3-C) shall form chevrons that point upwards.**

Option:

- 05 Appropriate signs (see Sections 2B.32 and 2C.25) directing traffic to one or both sides of the obstruction may be used instead of the object marker.

Section 2C.65 Object Markers for Obstructions Adjacent to the Roadway

Support:

- 01 Obstructions not actually within the roadway are sometimes so close to the edge of the road that they need a marker. These include underpass piers, bridge abutments, handrails, ends of traffic barriers, utility poles, and culvert headwalls. In other cases there might not be a physical object involved, but other roadside conditions exist, such as narrow shoulders, drop-offs, gores, small islands, and abrupt changes in the roadway alignment, that might make it undesirable for a road user to leave the roadway, and therefore would create a need for a marker.

Standard:

- 02 **If a Type 2 or Type 3 object marker is used to mark an obstruction adjacent to the roadway, the edge of the object marker that is closest to the road user shall be installed in line with the closest edge of the obstruction.**
- 03 **Where Type 3 object markers are applied to the approach ends of guardrail and other roadside appurtenances, sheeting without a substrate shall be directly affixed to the approach end of the guardrail in a rectangular shape conforming to the size of the approach end of the guardrail with**

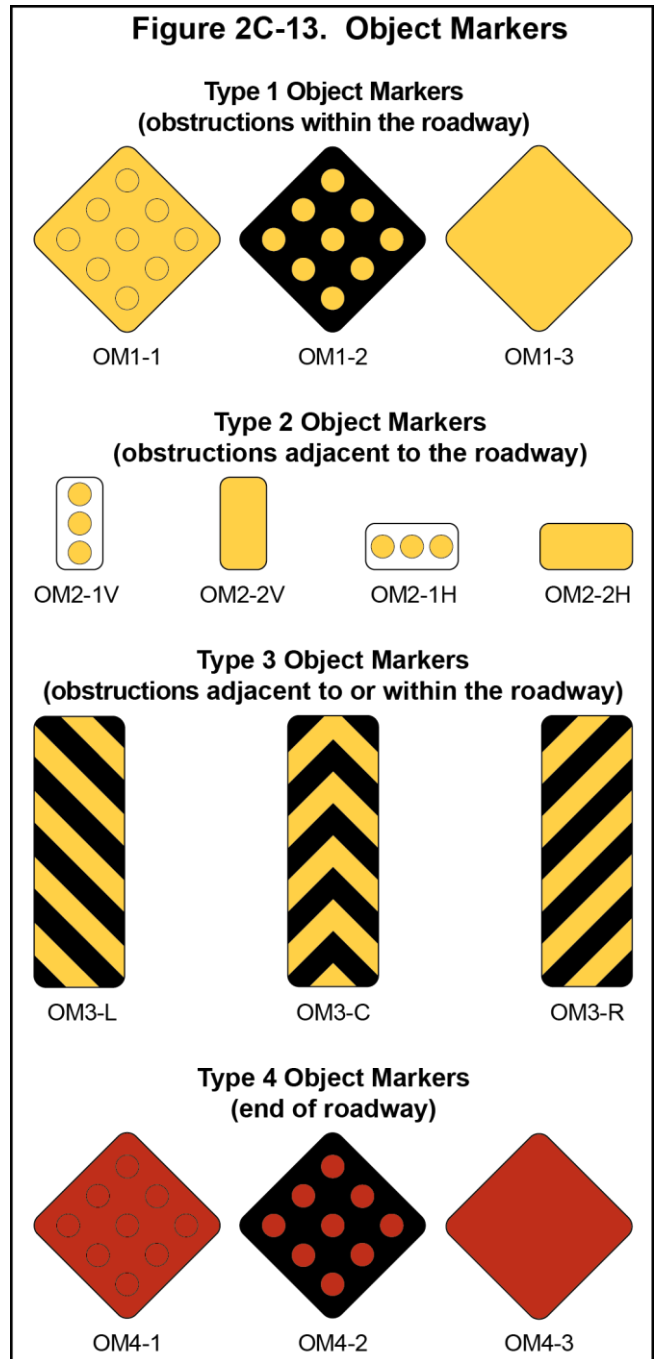

alternating black and retroreflective yellow stripes sloping downward at a angle of 45 degrees toward the side of the obstruction on which traffic is to pass.

04 **Type 1 and Type 4 object markers shall not be used to mark obstructions adjacent to the roadway.**

Guidance:

05 *Standard warning signs (in this Chapter) should also be used where applicable.*

Section 2C.66 Object Markers for Ends of Roadways

Support:

01 The Type 4 object marker is used to warn and alert road users of the end of a roadway in other than construction or maintenance areas.

Standard:

02 **If an object marker is used to mark the end of a roadway, a Type 4 object marker shall be used.**

Option:

03 The Type 4 object marker may be used in instances where there are no alternate vehicular paths.

04 Where conditions warrant, more than one marker, or a larger marker with or without a Type 3 Barricade (see Section 2B.67), may be used at the end of the roadway.

Standard:

05 **The minimum mounting height, measured vertically from the bottom of a Type 4 object marker to the elevation of the near edge of the traveled way, shall be 4 feet.**

Guidance:

06 *Appropriate advance warning signs (in this Chapter) should be used.*

CHAPTER 2D. GUIDE SIGNS—CONVENTIONAL ROADS

Section 2D.01 Scope of Conventional Road Guide Sign Standards

Standard:

- 01 **The provisions of this Chapter shall apply to any road or street other than low-volume roads (as defined in Section 5A.01), expressways, and freeways.**

Section 2D.02 Application

Support:

- 01 Guide signs are essential to direct road users along streets and highways, to inform them of intersecting routes, to direct them to cities, towns, villages, or other important destinations, to identify nearby rivers and streams, parks, forests, and historical sites, and generally to give such information as will help them along their way in the most simple, direct manner possible.
- 02 Chapter 2A addresses placement, location, and other general criteria for signs.

Section 2D.03 Color, Retroreflection, and Illumination

Support:

- 01 Requirements for illumination, retroreflection, and color are stated under the specific headings for individual guide signs or groups of signs. General provisions are given in Sections 2A.07, 2A.08, and 2A.10.

Standard:

- 02 **Except where otherwise provided in this Manual for individual signs or groups of signs, guide signs on streets and highways shall have a white message and border on a green background. All borders, and legends shall be retroreflective and all backgrounds shall be retroreflective or illuminated.**

Support:

- 03 Color coding is sometimes used to help road users distinguish between multiple potentially confusing destinations. Examples of valuable uses of color coding include guide signs for roadways approaching or inside an airport property with multiple terminals serving multiple airlines, and community wayfinding guide signs for various traffic generator destinations within a community or area.

Standard:

- 04 **Except where otherwise provided in this Manual, different color sign backgrounds shall not be used to provide color coding of destinations. The color coding shall be accomplished by the use of different colored square or rectangular sign panels on the face of the guide signs.**

Option:

- 05 The different colored sign panels may include a black or white (whichever provides the better contrast with the panel color) letter, numeral, or other appropriate designation to identify an airport terminal or other destination.

Support:

- 06 Two examples of color-coded sign assemblies are shown in Figure 2D-1. Section 2D.50 contains specific provisions regarding Community Wayfinding guide signs.

Section 2D.04 Size of Signs

Standard:

- 01 **Except as provided in Section 2A.11, the sizes of conventional road guide signs that have standardized designs shall be as shown in Table 2D-1.**

Support:

- 02 Section 2A.11 contains information regarding the applicability of the various columns in Table 2D-1.

Option:

- 03 Signs larger than those shown in Table 2D-1 may be used (see Section 2A.11).

Figure 2D-1. Examples of Color-Coded Destination Guide Signs

A - Freeway or Expressway – Airport Terminals



B - Conventional Road or Street – Urban Areas



Support:

- 04 For other guide signs, the legends are so variable that a standardized design or size is not appropriate. The sign size is determined primarily by the length of the message, and the size of lettering and spacing necessary for proper legibility.

Option:

- 05 Reduced letter height, reduced interline spacing, and reduced edge spacing may be used on guide signs if sign size must be limited by factors such as lane width or vertical or lateral clearance.

Guidance:

- 06 *Reduced spacing between the letters or words on a line of legend should not be used as a means of reducing the overall size of a guide sign, except where determined necessary by engineering judgment to meet unusual lateral space constraints. In such cases, the legibility distance of the sign legend should be the primary consideration in determining whether to reduce the spacing between the letters or the words or between the words and the sign border, or to reduce the letter height.*
- 07 *When a reduction in the prescribed size is necessary, the design used should be as similar as possible to the design for the standard size.*

Section 2D.05 Lettering Style

Standard:

- 01 The design of upper-case letters, lower-case letters, numerals, route shields, and spacing shall be as provided in the “Sign Designs and Markings Manual” (SDMM) (see Section 1A.11).
- 02 The lettering for names of places, streets, and highways on conventional road guide signs shall be a combination of lower-case letters with initial upper-case letters (see Section 2A.13). The nominal “loop” height of the lower-case letters shall be 3/4 the height of the initial upper-case letter. When a mixed-case legend letter height is specified referring only to the initial upper-case letter, the height of the lower-case letters that follow shall be determined by this proportion. When the height of a lower-case letter is referenced, the reference is made to the nominal loop height and the height of the initial upper-case letter shall also be determined by this proportion.

Table 2D-1. Conventional Road Guide Sign Sizes¹ (Sheet 1 of 2)

Sign	Sign Designation	Section	Conventional	Minimum	Oversized
Interstate Route Sign (1 or 2 digits)	M1-1	2D.11	24 x 24	24 x 24	36 x 36
Interstate Route Sign (3 digits)	M1-1	2D.11	30 x 24	30 x 24	45 x 36
Off-Interstate Route Sign (1 or 2 digits)	M1-2, 3	2D.11	24 x 24	24 x 24	36 x 36
Off-Interstate Route Sign (3 digits)	M1-2, 3	2D.11	30 x 24	30 x 24	45 x 36
U.S. Route Sign (1 or 2 digits)	M1-4	2D.11	24 x 24	24 x 24	36 x 36
U.S. Route Sign (3 digits)	M1-4	2D.11	30 x 24	30 x 24	45 x 36
State Route Sign (1 or 2 digits)	M1-5	2D.11	24 x 24	24 x 24	36 x 36
State Route Sign (3 digits)	M1-5	2D.11	30 x 24	30 x 24	45 x 36
County or Township Route Sign (1, 2, or 3 digits)	M1-6, H6a, H6b	2D.11	24 x 24	18 x 18	36 x 36
Forest Route (1, 2, or 3 digits)	M1-7	2D.11	24 x 24	18 x 18	36 x 36
Junction	M2-1	2D.13	21 x 15	21 x 15	30 x 21
Combination Junction (2 route signs)	M2-2	2D.14	60 x 48 ²	—	—
Cardinal Direction	M3-1, 2, 3, 4	2D.15	24 x 12	24 x 12	36 x 18
ALTERNATE	M4-1, 1a	2D.17	24 x 12	24 x 12	36 x 18
BY-PASS	M4-2	2D.18	24 x 12	24 x 12	36 x 18
BUSINESS	M4-3	2D.19	24 x 12	24 x 12	36 x 18
TRUCK	M4-4	2D.20	24 x 12	24 x 12	36 x 18
TO	M4-5	2D.21	24 x 12	24 x 12	36 x 18
END	M4-6	2D.22	24 x 12	24 x 12	36 x 18
TEMPORARY	M4-7, 7a	2D.24	24 x 12	24 x 12	36 x 18
BEGIN	M4-14	2D.23	24 x 12	24 x 12	36 x 18
Advance Turn Arrow	M5-1, 2, 3	2D.26	21 x 15	21 x 15	—
Lane Designation	M5-4, 5, 6	2D.27	24 x 18	24 x 18	36 x 24
Directional Arrow	M6-1, 2, 2a, 3, 4, 5, 6, 7	2D.28	21 x 15	21 x 15	30 x 21
Ohio Byway	M8-H3	2D.56	24 x 24	24 x 24	36 x 36
Ohio Byway Name	M8-H3P	2D.56	24 x 12	24 x 12	36 x 18
Destination (1 line)	D1-H1	2D.37	72 x 12	48 x 8	96 x 24
Destination and Distance (1 line)	D1-H1a	2D.37	72 x 12	48 x 8	96 x 24
Circular Intersection Destination (1 line)	D1-1d	2D.38	Varies x 18	Varies x 18	—
Circular Intersection Departure Guide	D1-1e	2D.38	Varies x 42 ²	—	—
Circular Intersection Destination (2 lines)	D1-2d	2D.38	Varies x 30	Varies x 30	—
Circular Intersection Destination (3 lines)	D1-3d	2D.38	Varies x 42	Varies x 42	—
Distance (1 line)	D2-H1	2D.41	72 x 12	72 x 12	96 x 24
Distance (2 lines)	D2-H2	2D.41	72 x 24	72 x 24	96 x 36
Distance (3 lines)	D2-H3	2D.41	72 x 36	72 x 36	96 x 48
Street Name (1 line)	D3-1, 1a	2D.43	Varies x 12	Varies x 8	Varies x 18
Advance Street Name (2 lines)	D3-2	2D.44	Varies x 30	—	—
Advance Street Name (3 lines)	D3-2	2D.44	Varies x 42	—	—
Advance Street Name (4 lines)	D3-2	2D.44	Varies x 54	—	—
Parking Area	D4-1	2D.47	30 x 24	18 x 15	—
Park - Ride	D4-2	2D.48	30 x 36	24 x 30	36 x 48
National Scenic Byways	D6-4	2D.55	24 x 24	24 x 24	—
National Scenic Byways	D6-4a	2D.55	24 x 12	24 x 12	—
Weigh Station XX Miles	D8-1	2D.49	78 x 60	60 x 48	96 x 72
Weigh Station – Open/Closed	D8-H2	2D.49	96 x 48	—	156 x 72
Weigh Station (with arrow)	D8-3	2D.49	66 x 60	48 x 42	84 x 72
Crossover	D13-1, 2	2D.54	60 x 30	60 x 30	78 x 42
Freeway Entrance	D13-3	2D.46	48 x 30	48 x 30	—
Freeway Entrance (with arrow)	D13-3a	2D.46	48 x 42	48 x 42	—

Table 2D-1. Conventional Road Guide Sign Sizes¹ (Sheet 2 of 2)

Sign	Sign Designation	Section	Conventional	Minimum	Oversized
Combination Lane Use / Destination	D15-1	2D.33	Varies x 96	Varies x 96	—
Next Truck Lane XX Miles	D17-1	2D.51	42 x 48	42 x 48	60 x 66
Truck Lane XX Miles	D17-2	2D.51	42 x 42	42 x 42	60 x 54
Slow Vehicle Turn-Out XX Miles	D17-7	2D.52	72 x 42	72 x 42	96 x 54

- Notes: 1. a. Larger signs may be used when appropriate.
b. Dimensions in inches are shown as width x height.
2. The size shown is for a typical sign. The size should be appropriately based on the amount of legend required for the sign.

03 **All other word legends on conventional road guide signs shall be in upper-case letters.**

04 **The unique letter forms for each of the Standard Alphabet series shall not be stretched, compressed, warped, or otherwise manipulated. Modifications to the length of a word for a given letter height and series shall be accomplished only by the methods described in Section 2D.04.**

Section 2D.06 Size of Lettering

Support:

01 Sign legibility is a direct function of letter size and spacing. Legibility distance has to be sufficient to give road users enough time to read and comprehend the sign. Under optimum conditions, a guide sign message can be read and understood in a brief glance. The legibility distance takes into account factors such as inattention, blocking of view by other vehicles, unfavorable weather, inferior eyesight, or other causes for delayed or slow reading. Where conditions permit, repetition of guide information on successive signs gives the road user more than one opportunity to obtain the information needed.

Standard:

02 **Design layouts for conventional road guide signs showing interline spacing, edge spacing, and other specification details shall be as shown in the SDMM (see Section 1A.11).**

03 **The principal legend on guide signs shall be in letters and numerals at least 6 inches in height for all upper-case letters, or a combination of 6 inches in height for upper-case letters and 4.5 inches in height for lower-case letters. On low-volume roads (as defined in Section 5A.01) with speeds of 25 mph or less, and on urban streets with speeds of 25 mph or less, the principal legend shall be in letters at least 4 inches in height for all upper-case letters, or a combination of 4 inches in height for upper-case letters and 3 inches in height for lower-case letters.**

Guidance:

04 *Lettering sizes should be consistent on any particular class of highway.*

05 *The minimum lettering sizes provided in this Manual should be exceeded where conditions indicate a need for greater legibility.*

Section 2D.07 Amount of Legend

Support:

01 The longer the legend on a guide sign, the longer it will take road users to comprehend it, regardless of letter size.

Guidance:

02 *Except where otherwise provided in this Manual, guide signs should be limited to no more than three lines of destinations, which include place names, route numbers, street names, and cardinal directions. Where two or more signs are included in the same overhead display, the amount of legend should be further minimized. Where appropriate, a distance message or action information, such as an exit number, NEXT RIGHT, or directional arrows, should be provided on guide signs in addition to the destinations.*

Section 2D.08 Arrows

Support:

- 01 Arrows are used for lane assignment and to indicate the direction toward designated routes or destinations. Figure 2D-2 shows the various standard arrow designs that have been approved for use on guide signs. Detailed drawings and standardized sizes based on ranges of letter heights are shown for these arrows in the SDMM (see Section 1A.11).

Standard:

- 02 **On overhead signs where it is desirable to indicate a lane to be followed, a down arrow shall be positioned approximately over the center of the lane and shall point vertically downward toward the approximate center of that lane. Down arrows shall be used only on overhead guide signs that restrict the use of specific lanes to traffic bound for the destination(s) and/or route(s) indicated by these arrows. Down arrows shall not be used unless an arrow can be located over and pointed to the appropriate center of each lane that can be used to reach the destination displayed on the sign.**
- 03 **If down arrows are used, having more than one down arrow pointing to the same lane on a single overhead sign (or on multiple signs on the same overhead sign structure) shall not be permitted.**
- 04 **Where a roadway is leaving the through lanes, a directional arrow shall point upward at an angle that approximates the alignment of the exit roadway.**

Option:

- 05 Curved-stem arrows (see Figure 2D-8) that represent the intended driver paths to destinations involving left-turn movements may be used on guide signs on approaches to circular intersections.

Standard:

- 06 **Curved-stem arrows shall not be used on any sign that is not associated with a circular intersection.**

Guidance:

- 07 *If curved-stem arrows are used, the principles set forth in Sections 2D.26 through 2D.29 should be followed.*
- 08 *The Type A directional arrow should be used on guide signs on freeways, expressways, and conventional roads to indicate the direction to a specific destination or group of destinations, except as otherwise provided in this Section and in Section 2E.19.*
- 09 *When a directional arrow in a vertical, upward-pointing orientation is placed to the side of a group of destinations to indicate a through movement, the Type A directional arrow should be used. When a directional arrow in a vertical, upward-pointing orientation is placed to the side of a single destination or under a destination or group of destinations, the Type B directional arrow should be used.*
- 10 *The Type B directional arrow should be used on guide signs on conventional roads when placed at any angle to the side of a single destination or when placed in a horizontal orientation to the side of a group of destinations.*
- 11 *The Type C advance turn directional arrow should be used on conventional road guide signs placed in advance of an intersection where a turn must be made to reach a posted destination or group of destinations.*
- 12 *The Type D directional arrow should be used primarily for sign applications other than guide signs, except as provided in Paragraph 16.*

Option:

- 13 The Type A-Extended directional arrow may be used on guide signs where additional emphasis regarding the direction is needed relative to the amount of legend on the sign.
- 14 The Type C directional arrow may be used to the side of the legend of an overhead guide sign to accentuate a sharp turn exit maneuver from a mainline roadway (see Section 2E.36 for additional information regarding Exit Direction signs for low advisory ramp speeds).
- 15 On conventional roads on the approach to an intersection where the Combination Lane-Use/Destination overhead guide sign (see Section 2D.33) is not used, the Type C advance turn directional arrow may be used beneath the legend of an overhead guide sign to indicate the fact that a turn must be made from a mandatory movement lane over which the sign is placed to reach the destination or destinations displayed on the sign.

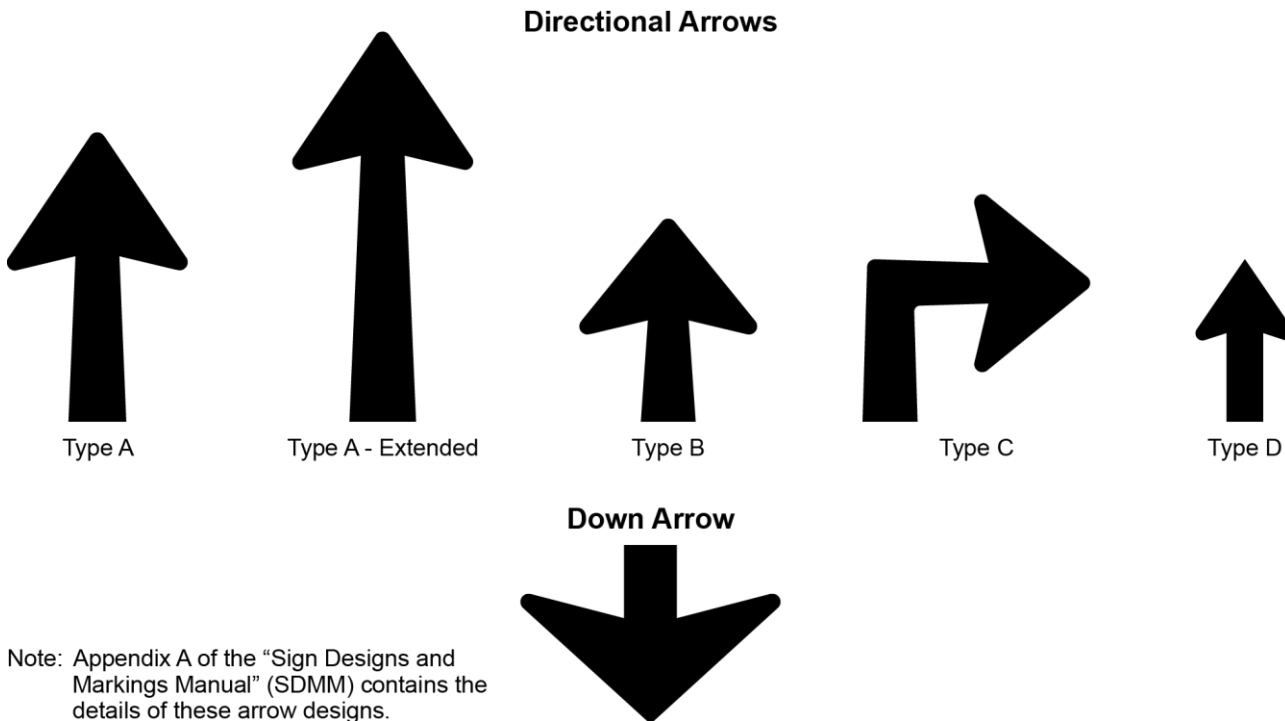
Figure 2D-2. Arrows for Use on Guide Signs

Note: Appendix A of the "Sign Designs and Markings Manual" (SDMM) contains the details of these arrow designs.

Curved-stem arrows, used on approaches to circular intersections, are shown in Figures 2D-5, 2D-8, 2D-9 and 2D-10.

16 The Type D directional arrow may be used on post-mounted guide signs on conventional roads if the height of the text on the sign is 8 inches or less.

17 The directional and down arrows shown in Figure 2D-2 may be used on signs other than guide signs for the purposes of providing directional guidance and lane assignment.

Guidance:

18 *Arrows used on guide signs to indicate the directions toward designated routes or destinations should be pointed at the appropriate angle to clearly convey the direction to be taken. A horizontally oriented directional arrow design should be used at right-angle intersections.*

19 *On a post-mounted guide sign, a directional arrow for a straight-through movement should point upward. Except as provided in Section 2D.46, for a turn, the arrow on a guide sign should point horizontally or at an upward angle that approximates the sharpness of the turn.*

20 *At an exit, an arrow should be placed at the side of the sign that will reinforce the movement of exiting traffic. The directional arrow design should be used.*

Option:

21 Arrows may be placed below the principal sign legend or on the appropriate side of the legend.

22 On a post-mounted sign at an exit where placement of the arrow to the side of the legend farthest from the roadway would create an unusually wide sign that limits the road user's view of the arrow, the directional arrow may be placed at the bottom portion of the sign, centered under the legend.

Guidance:

23 *The width across the arrowhead for the Types A, B, and C directional arrows should be between 1.5 and 1.75 times the height of the upper-case letters of the principal legend on the sign. The width across the arrowhead for the Type D directional arrow should be at least equal to the height of the upper-case letters of the principal legend on the sign. For down arrows used on overhead signs, the width across the arrowhead should be approximately two times the height of the upper-case letters of the principal legend on the sign.*

24 Arrows used in Overhead Arrow-per-Lane and Diagrammatic guide signing, if used on conventional roads, except for signs on approaches to roundabouts, should follow the principles set forth in Section 2E.19. Arrows used in Diagrammatic guide signing on approaches to roundabouts should follow the principles set forth in Section 2D.38.

Support:

25 The “Sign Designs and Markings Manual” (SDMM) (see Section 1A.11) contains design details and standardized sizes of the various arrows based on ranges of letter heights of principal legends.

Section 2D.09 Numbered Highway Systems

Support:

01 The purpose of numbering and signing highway systems is to identify routes and facilitate travel.

02 The Interstate and United States (U.S.) highway systems are numbered by the American Association of State Highway and Transportation Officials (AASHTO) upon recommendations of the State highway organizations because the respective States own these systems. State and county road systems are numbered by the appropriate authorities.

03 The basic policy for numbering the Interstate and U.S. highway systems is contained in the following Purpose and Policy statements published by AASHTO (see the Preface for AASHTO’s address):

- A. “Establishment and Development of United States Numbered Highways,” and
- B. “Establishment of a Marking System of the Routes Comprising the National System of Interstate and Defense Highways.”

Guidance:

04 *The principles of these policies should be followed in establishing the highway systems described in Paragraph 2 and any other systems, with effective coordination between adjacent jurisdictions. Care should be taken to avoid the use of numbers or other designations that have been assigned to Interstate, U.S., or State routes in the same geographic area. Overlapping numbered routes should be kept to a minimum.*

Standard:

05 **Route systems shall be given preference in this order: Interstate, United States, State, and county. The preference shall be given by installing the highest-priority legend on the top or the left of the sign.**

Support:

06 Section 2D.53 contains information regarding the signing of unnumbered highways to enhance route guidance and facilitate travel.

Section 2D.10 Route Signs and Auxiliary Signs

Standard:

01 **All numbered highway routes shall be identified by route signs and auxiliary signs.**

02 **The signs for each system of numbered highways, which are distinctive in shape and color, shall be used only on that system and the approaches thereto.**

Option:

03 Route signs and auxiliary signs may be proportionally enlarged where greater legibility is needed.

Support:

04 Route signs are typically mounted in assemblies with auxiliary signs.

05 Section 2D.53 addresses Named Highways and Section 2M.10 addresses Memorial or Dedication signing.

06 Section 2D.55 contains information regarding the signing for National Scenic Byways, and signing for the Ohio Byways program is discussed in Section 2D.56.

07 Section 2H.07 contains information regarding the signing for Auto Tour Routes.

Section 2D.11 Design of Route Signs

Standard:

01 The **SDMM** (see Section 1A.11) shall be used for designing route signs. Other route sign designs shall be established by the authority having jurisdiction.

02 Interstate Route signs (see Figure 2D-3) shall consist of a cutout shield, with the route number in white letters on a blue background, the word **INTERSTATE** in white upper-case letters on a red background, and a white border. This sign shall be used on all Interstate routes and in connection with route sign assemblies on intersecting highways.

03 A 24 x 24-inch minimum sign size shall be used for Interstate route numbers with one or two digits, and a 30 x 24-inch minimum sign size shall be used for Interstate route numbers having three digits.

04 Off-Interstate Business Route signs (see Figure 2D-3) shall consist of a cutout shield carrying the number of the connecting Interstate route and the words **BUSINESS** and either **LOOP** or **SPUR** in upper-case letters. The legend and border shall be white on a green background, and the shield shall be the same shape and dimensions as the Interstate Route sign. In no instance shall the word **INTERSTATE** appear on the Off-Interstate Business Route sign.

Option:

05 The Off-Interstate Business Route sign may be used on a major highway that is not a part of the Interstate system, but one that serves the business area of a city from an interchange on the system.

06 When used on a green guide sign, a white square or rectangle may be placed behind the shield to improve contrast.

Standard:

07 U.S. Route signs (see Figure 2D-3) shall consist of black numerals on a white shield surrounded by a rectangular black background without a border. This sign shall be used on all U.S. routes and in connection with route sign assemblies on intersecting highways.

08 A 24 x 24-inch minimum sign size shall be used for U.S. route numbers with one or two digits, and a 30 x 24-inch minimum sign size shall be used for U.S. route numbers having three digits.

09 State Route signs shall consist of black numerals on a white representation of the State of Ohio surrounded by a rectangular black background without a border. A design detail is provided in the **SDMM** (see Section 1A.11). This sign shall be used on all State Routes and in connection with route sign assemblies on intersecting highways.

10 A 24 x 24-inch minimum sign size shall be used for State Route numbers with one or two digits, and a 30 x 24-inch minimum sign size shall be used for State Route numbers having three digits.

Guidance:

11 *Where U.S. or State Route signs are used as components of guide signs, only the distinctive shape of the shield itself and the route numerals within should be used. The rectangular background upon which the distinctive shape of the shield is mounted, such as the black area around the outside of the shields on the M1-4 and standard M1-5 signs, should not be included on the guide sign. Where U.S. or State Route signs are used as components of other signs of non-contrasting background colors, the rectangular background should be used so that recognition of the distinctive shape of the shield can be maintained.*

Standard:

12 If county road authorities elect to establish and identify a special system of important county roads, a statewide policy for such signing shall be established that includes a uniform numbering system to uniquely identify each route. The County Route (M1-6) sign (see Figure 2D-3) shall consist of a pentagon shape with a yellow county name and route number and border on a blue background. County Route signs displaying two digits or the equivalent (letter and numeral, or two letters) shall be a minimum size of 18 x 18 inches; those carrying three digits or the equivalent shall be a minimum size of 24 x 24 inches.

13 If a jurisdiction uses letters instead of numbers to identify routes, all references to numbered routes in this Chapter shall be interpreted to also include lettered routes.

Figure 2D-3. Route Signs

Interstate Route Sign
M1-1Off-Interstate Business Route Sign
M1-2 (Loop), M1-3 (Spur)U.S. Route Sign
M1-4State Route Sign
M1-5County Route Sign
M1-6Alternate County Route Sign
M1-H6aTownship Route Sign
M1-H6bForest Route Sign
M1-7*Guidance:*

- 14 If used with other route signs in common assemblies, the County Route sign should be of a size compatible with that of the other route signs.

Option:

- 15 When used on a green guide sign, a yellow square or rectangle may be placed behind the County Route sign to improve contrast.
- 16 The alternate County Route (M1-H6a) sign may be used on County Roads, and the Township Route (M1-H6b) sign may be used on Township Roads. These signs have a minimum size of 18 x 18 inches for two and three digit routes (see Figure 2D-3).

Guidance:

- 17 If used with other route signs in common assemblies, the alternate design County Route sign and Township Route sign should be of a size compatible with that of the other route signs.

Standard:

- 18 Route signs (see Figure 2D-3) for park and forest roads shall be designed with adequate distinctiveness and legibility and of a size compatible with other route signs used in common assemblies.

Section 2D.12 Design of Route Sign Auxiliaries**Standard:**

- 01 Route sign auxiliaries carrying word legends, except the JCT sign, shall have a standard size of 24 x 12 inches. Those carrying arrow symbols, or the JCT sign, shall have a standard size of 21 x 15 inches. All route sign auxiliaries shall match the color combination of the route sign that they supplement.

Guidance:

- 02 With route signs of larger heights, auxiliary signs should be suitably enlarged, but not such that they exceed the width of the route sign.

03 *The background, legend, and border of a route sign auxiliary should have the same colors as those of the route sign with which the auxiliary is mounted in a route sign assembly (see Section 2D.29). For a route sign design that uses multiple background colors, such as the Interstate route sign, the background color of the corresponding auxiliary should be that of the background area on which the route number is placed on the route sign.*

Option:

04 A route sign and any auxiliary signs used with it may be combined on a single panel.

Guidance:

05 *If a route sign and its auxiliary signs are combined to form a single guide sign, the background color of the sign should be green and the design should comply with the basic principles for the design of guide signs.*

Standard:

06 **If a route sign and its auxiliary signs are combined on a single sign with a green background, the auxiliary messages shall be white legends placed directly on the green background. Auxiliary signs shall not be mounted directly to a guide sign or other type of sign.**

Support:

07 Chapter 2F contains information regarding auxiliary signs for toll highways.

Section 2D.13 Junction Auxiliary Sign (M2-1)

Standard:

01 **The Junction (M2-1) auxiliary sign (see Figure 2D-4) shall carry the abbreviated legend JCT and shall be mounted at the top of an assembly (see Section 2D.30) directly above the route sign, the sign for an alternative route (see Section 2D.17) that is part of the route designation, or the Cardinal Direction auxiliary sign where access is available only to one direction of the intersected route. The minimum size of the Junction auxiliary sign shall be 21 x 15 inches for compatibility with auxiliary signs carrying arrow symbols.**

Section 2D.14 Combination Junction Sign (M2-2)

Option:

01 As an alternative to the standard Junction assembly where more than one route is to be intersected or joined, a rectangular guide sign may be used carrying the word JUNCTION above the route numbers.

Standard:

02 **The Combination Junction (M2-2) sign (see Figure 2D-4) shall have a green background with white border and lettering for the word JUNCTION.**

Guidance:

03 *The Combination Junction sign should comply with the specific provisions of Section 2D.11 regarding the incorporation of the route signs as components of guide signs.*

04 *Although the size of the Combination Junction sign will depend on the number of routes involved, the numerals should be large enough for clear legibility and should be of a size comparable with those in the individual route signs.*

Section 2D.15 Cardinal Direction Auxiliary Signs (M3-1 through M3-4)

Guidance:

01 *Cardinal Direction auxiliary signs (see Figure 2D-4) carrying the legend NORTH, EAST, SOUTH, or WEST should be used to indicate the general direction of the entire route.*

Standard:

02 **To improve the readability and recognition of the cardinal directions, the first letter of the cardinal direction words shall be ten percent larger, rounded up to the nearest whole number size.**

03 **If used, the Cardinal Direction auxiliary sign shall be mounted directly above a route sign or, if used, an auxiliary sign for an alternative route.**

Figure 2D-4. Route Sign Auxiliaries

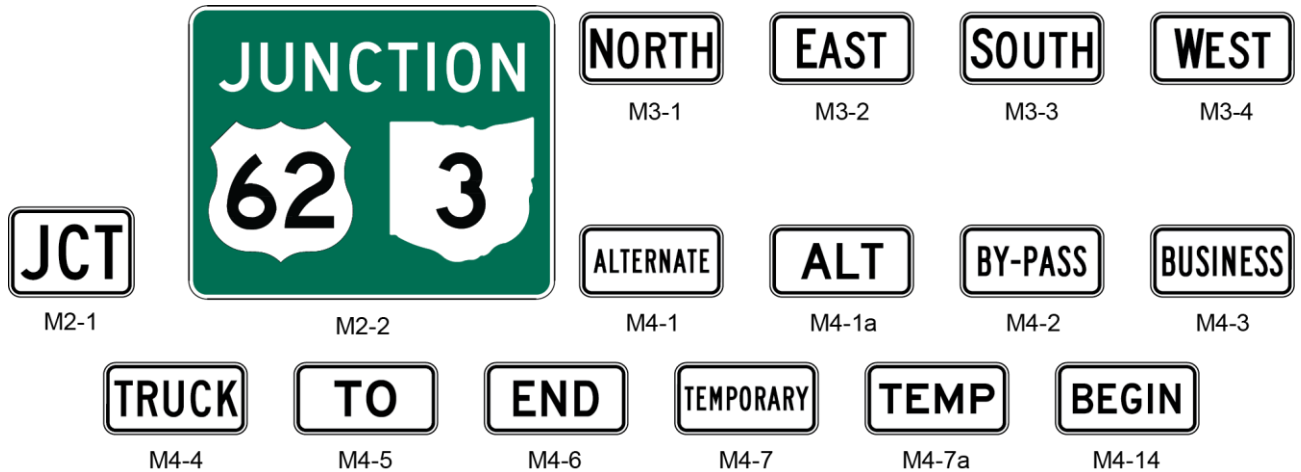

Section 2D.16 Auxiliary Signs for Alternative Routes (M4 Series)

Option:

- 01 Auxiliary signs, carrying legends such as ALTERNATE, BY-PASS, BUSINESS, or TRUCK, may be used to indicate an alternate route of the same number between two points on that route.

Standard:

- 02 **If used, the auxiliary signs for alternative routes shall be mounted directly above a route sign.**

Section 2D.17 ALTERNATE Auxiliary Signs (M4-1, M4-1a)

Option:

- 01 The ALTERNATE (M4-1) or the ALT (M4-1a) auxiliary sign (see Figure 2D-4) may be used to indicate an officially designated alternate routing of a numbered route between two points on that route.

Standard:

- 02 **If used, the ALTERNATE or ALT auxiliary sign shall be mounted directly above a route sign.**

Guidance:

- 03 *The shorter (time or distance) or better-constructed route should retain the regular route number, and the longer or worse-constructed route should be designated as the alternate route.*

Section 2D.18 BY-PASS Auxiliary Sign (M4-2)

Option:

- 01 The BY-PASS (M4-2) auxiliary sign (see Figure 2D-4) may be used to designate a route that branches from the numbered route through a city, bypasses a part of the city or congested area, and rejoins the numbered route beyond the city.

Standard:

- 02 **If used, the BY-PASS auxiliary sign shall be mounted directly above a route sign.**

Section 2D.19 BUSINESS Auxiliary Sign (M4-3)

Option:

- 01 The BUSINESS (M4-3) auxiliary sign (see Figure 2D-4) may be used to designate an alternate route that branches from a numbered route, passes through the business portion of a city, and rejoins the numbered route beyond that area.

Standard:

- 02 **If used, the BUSINESS auxiliary sign shall be mounted directly above a route sign.**

Section 2D.20 TRUCK Auxiliary Sign (M4-4)**Option:**

- 01 The TRUCK (M4-4) auxiliary sign (see Figure 2D-4) may be used to designate an alternate route that branches from a numbered route, when it is desirable to encourage or require commercial vehicles to use the alternate route.

Standard:

- 02 **If used, the TRUCK auxiliary sign shall be mounted directly above a route sign.**

Section 2D.21 TO Auxiliary Sign (M4-5)**Option:**

- 01 The TO (M4-5) auxiliary sign (see Figure 2D-4) may be used to provide directional guidance to a particular road facility from other highways in the vicinity (see Section 2D.35).

Standard:

- 02 **If used, the TO auxiliary sign shall be mounted directly above a route sign or an auxiliary sign for an alternative route. If a Cardinal Direction auxiliary sign is also included in the assembly, the TO auxiliary sign shall be mounted directly above the Cardinal Direction auxiliary sign.**

Section 2D.22 END Auxiliary Sign (M4-6)*Guidance:*

- 01 *The END (M4-6) auxiliary sign (see Figure 2D-4) should be used where the route being traveled ends, usually at a junction with another route.*

Standard:

- 02 **If used, the END auxiliary sign shall be mounted either directly above a route sign or above a sign for an alternative route that is part of the designation of the route being terminated.**

Section 2D.23 BEGIN Auxiliary Sign (M4-14)**Option:**

- 01 The BEGIN (M4-14) auxiliary sign (see Figure 2D-4) may be used where a route begins, usually at a junction with another route.

Standard:

- 02 **If used, the BEGIN auxiliary sign shall be mounted at the top of the first Confirming assembly (see Section 2D.34) for the route that is beginning.**

Guidance:

- 03 *If a BEGIN auxiliary sign is included in the first Confirming assembly, a Cardinal Direction auxiliary sign should also be included in the assembly.*

Standard:

- 04 **If a Cardinal Direction auxiliary sign is also included in the assembly, the BEGIN auxiliary sign shall be mounted directly above the Cardinal Direction auxiliary sign.**

Section 2D.24 TEMPORARY Auxiliary Signs (M4-7, M4-7a)**Option:**

- 01 The TEMPORARY (M4-7) or the TEMP (M4-7a) auxiliary sign (see Figure 2D-4) may be used for an interim period to designate a section of highway that is not planned as a permanent part of a numbered route, but that connects completed portions of that route.

Standard:

- 02 **If used, the TEMPORARY or TEMP auxiliary sign shall be mounted directly above the route sign, above a Cardinal Direction sign, or above a sign for an alternate route that is a part of the route designation.**

- 03 **TEMPORARY or TEMP auxiliary signs shall be promptly removed when the temporary route is abandoned.**

Section 2D.25 Temporary Detour and Auxiliary Signs

Support:

- 01 Chapter 6F contains information regarding Temporary Detour and Auxiliary signs.

Section 2D.26 Advance Turn Arrow Auxiliary Signs (M5-1, M5-2, M5-3)

Standard:

- 01 If used, the Advance Turn Arrow auxiliary sign (see Figure 2D-5) shall be mounted directly below the route sign in Advance Route Turn assemblies, and displays a right or left arrow, the shaft of which is bent at a 90-degree angle (M5-1) or at a 45-degree angle (M5-2).

- 02 If used, the curved-stem Advance Turn Arrow auxiliary (M5-3) sign shall be used only on the approach to a circular intersection to depict a movement along the circulatory roadway around the central island and to the left, relative to the approach roadway and entry into the intersection.

Guidance:

- 03 If the M5-3 sign is used, then this arrow type should also be used consistently on any regulatory lane-use signs (see Chapter 2B), Destination signs (see Section 2D.37), and pavement markings (see Part 3) for a particular destination or movement.

Section 2D.27 Lane Designation Auxiliary Signs (M5-4, M5-5, M5-6)

Option:

- 01 A Lane Designation (M5-4, M5-5, or M5-6) auxiliary sign (see Figure 2D-5) may be mounted directly below the route sign in an Advance Route Turn assembly on multi-lane roadways to allow road users to move into the appropriate lane prior to reaching the intersection or interchange.

Standard:

- 02 If used, the Lane Designation auxiliary signs shall be used only where the designated lane is a mandatory movement lane and shall be located adjacent to the full-width portion of the mandatory movement lane. The Lane Designation auxiliary signs shall not be installed adjacent to a through lane in advance of a lane that is being added or along the taper for a lane that is being added.

Figure 2D-5. Advance Turn and Directional Arrow Auxiliary Signs

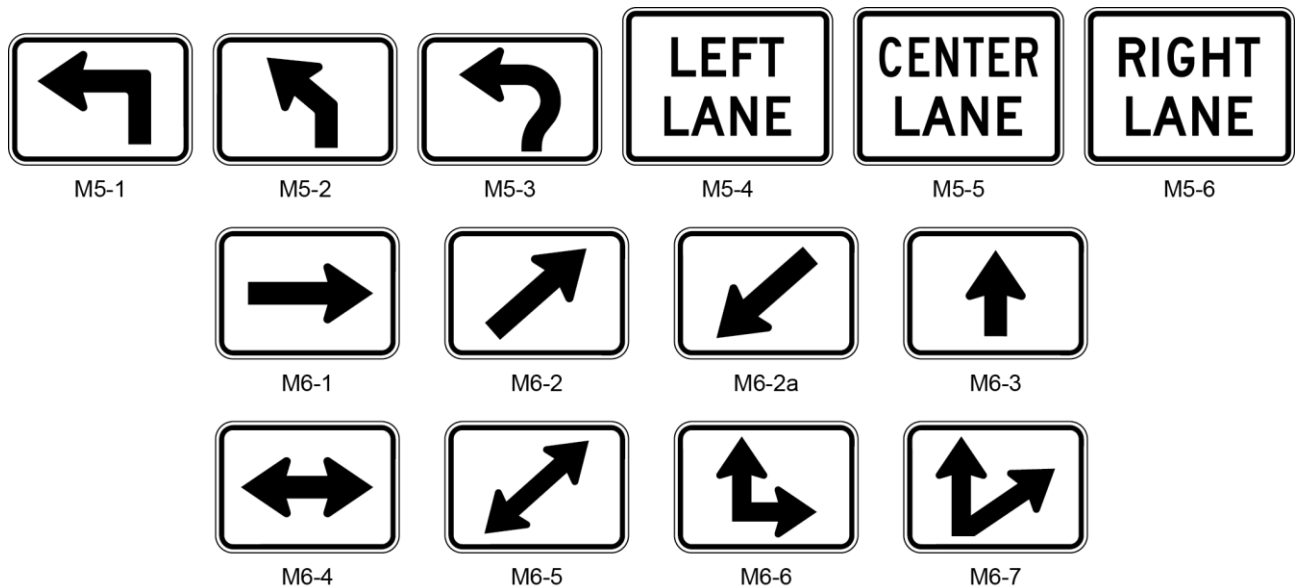

Section 2D.28 Directional Arrow Auxiliary Signs (M6 Series)

Standard:

01 **If used, the Directional Arrow auxiliary sign (see Figure 2D-5) shall be mounted below the route sign and any other auxiliary signs in directional assemblies (see Section 2D.32), and displays a single- or double-headed arrow pointing in the general direction that the route follows.**

02 **A Directional Arrow auxiliary sign that displays a double-headed arrow shall not be mounted in any Directional assembly in advance of or at a circular intersection.**

Option:

03 **The downward pointing diagonal arrow auxiliary (M6-2a) sign may be used in a Directional assembly at the far corner of an intersection to indicate the immediate entry point to a freeway or expressway entrance ramp (see Section 2D.46).**

Standard:

04 **The M6-2a sign shall not be used on the approach to or on the near side of an intersection, such as to designate an approach lane.**

Section 2D.29 Route Sign Assemblies

Standard:

01 **A Route Sign assembly shall consist of a route sign and auxiliary signs that further identify the route and indicate the direction. Route Sign assemblies shall be installed on all approaches to numbered routes that intersect with other numbered routes.**

02 **Where two or more routes follow the same section of highway, the route signs for Interstate, U.S., State, and county routes shall be mounted in that order from the left in horizontal arrangements and from the top in vertical arrangements. Subject to this order of precedence, route signs for lower-numbered routes shall be placed at the left or top.**

03 **Within groups of assemblies, information for routes intersecting from the left shall be mounted at the left in horizontal arrangements and at the top or center of vertical arrangements. Similarly, information for routes intersecting from the right shall be at the right or bottom, and for straight-through routes at the center in horizontal arrangements or top in vertical arrangements.**

04 **Route Sign assemblies shall be mounted in accordance with the general specifications for signs (Chapter 2A), with the lowest sign in the assembly at the height prescribed for single signs.**

Guidance:

05 *Assemblies for two or more routes, or for different directions on the same route, should be mounted in groups on a common support.*

Option:

06 **Route Sign assemblies may be installed on the approaches to numbered routes on unnumbered roads and streets that carry an appreciable amount of traffic destined for the numbered route.**

07 **The diagrammatic route guide sign format, such as the D1-5 and D1-5a signs shown in Figure 2D-8, may be used on approaches to roundabouts.**

08 **If engineering judgment indicates that groups of assemblies that include overlapping routes or multiple turns might be confusing, route signs or auxiliary signs may be omitted or combined, provided that clear directions are given to road users.**

Support:

09 **Figure 2D-6 shows typical placements of route signs.**

Section 2D.30 Junction Assembly

Standard:

01 **A Junction assembly shall consist of a Junction auxiliary sign and a route sign. The route sign shall carry the number of the intersected or joined route.**

02 **The Junction assembly shall be installed in advance of every intersection where a U.S. or State Route is intersected or joined by another U.S. or State Route.**

Figure 2D-6. Illustration of Directional Assemblies and Other Route Signs (for One Direction of Travel Only) (Sheet 1 of 4)

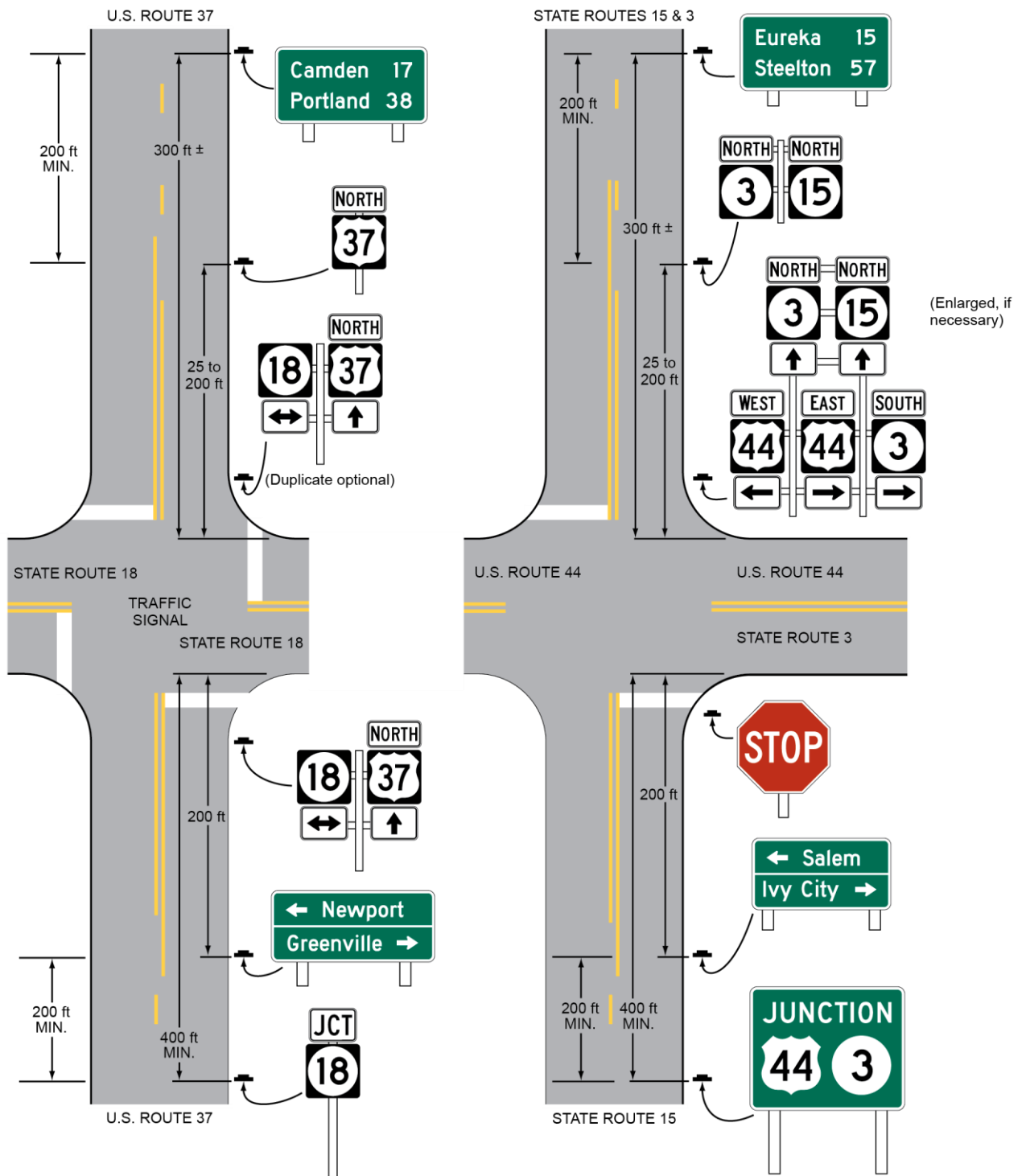

Notes: The spacings shown on this figure are for rural intersections. See Sections 2D.29, 2D.30, 2D.32, 2D.34, 2D.40, and 2D.42 for low-speed and/or urban conditions. Figures 2D-3 and 2D-4 show the correct design of an Ohio State Route Sign.

Figure 2D-6. Illustration of Directional Assemblies and Other Route Signs (for One Direction of Travel Only) (Sheet 2 of 4)

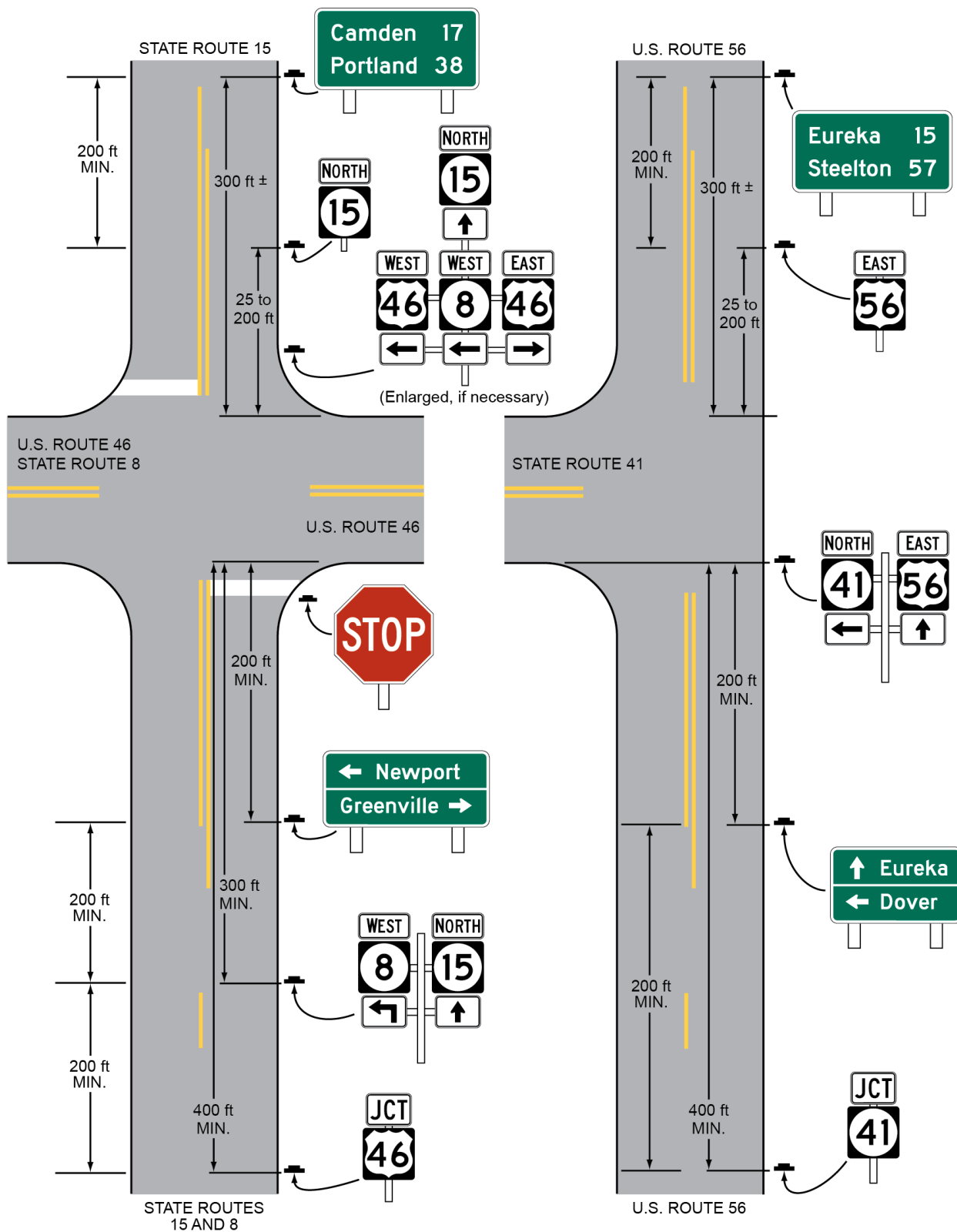

Notes: The spacings shown on this figure are for rural intersections. See Sections 2D.29, 2D.30, 2D.32, 2D.34, 2D.40, and 2D.42 for low-speed and/or urban conditions. Figure 2D-3 shows the correct design of an Ohio State Route sign.

Figure 2D-6. Illustration of Directional Assemblies and Other Route Signs (for One Direction of Travel Only) (Sheet 3 of 4)

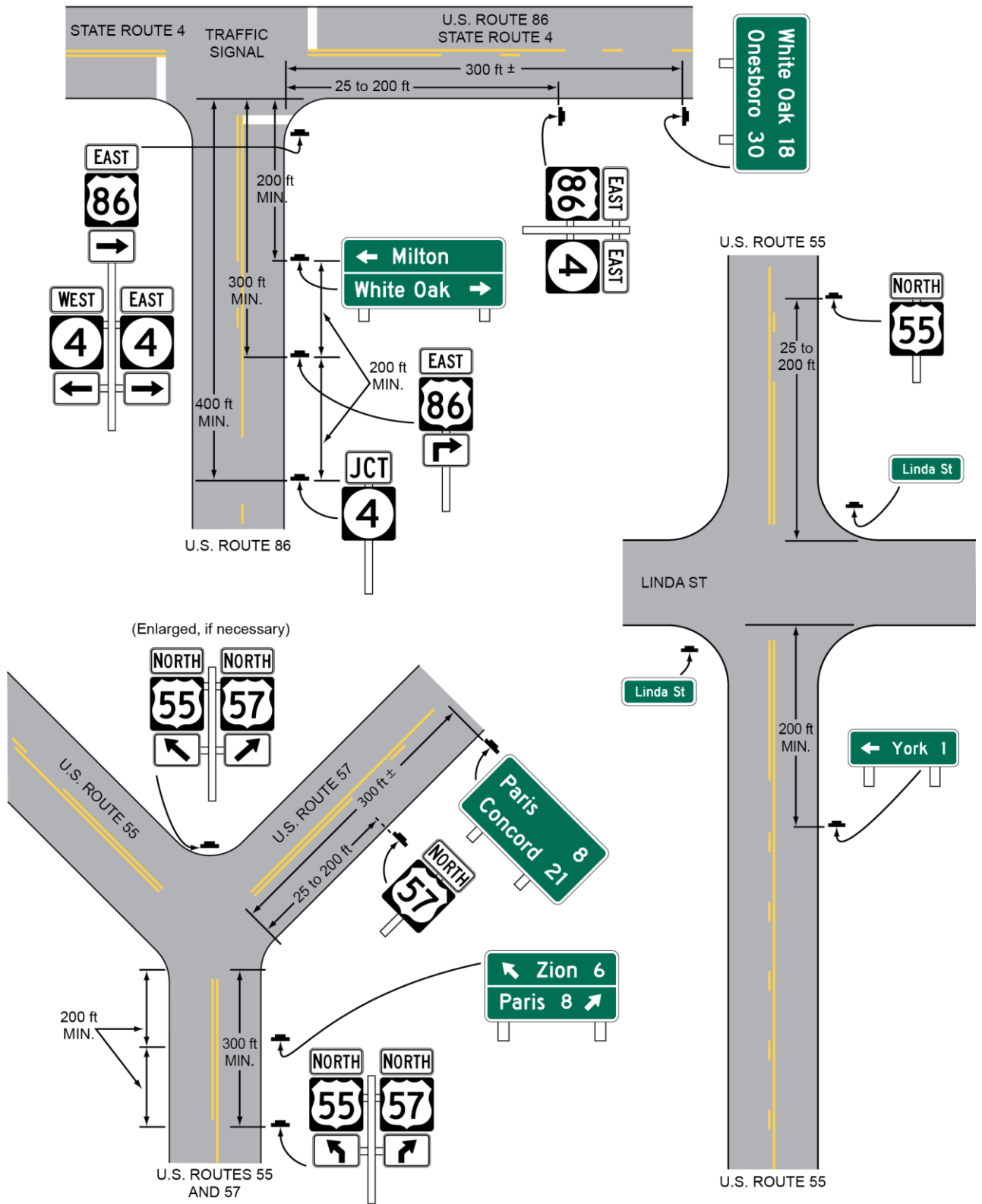

Note: The spacings shown on this figure are for rural intersections. See Sections 2D.29, 2D.30, 2D.32, 2D.34, 2D.40, and 2D.42 for low-speed and/or urban conditions. Figure 2D-3 shows the correct design of an Ohio State Route sign.

Figure 2D-6. Illustration of Directional Assemblies and Other Route Signs (for One Direction of Travel Only) (Sheet 4 of 4)

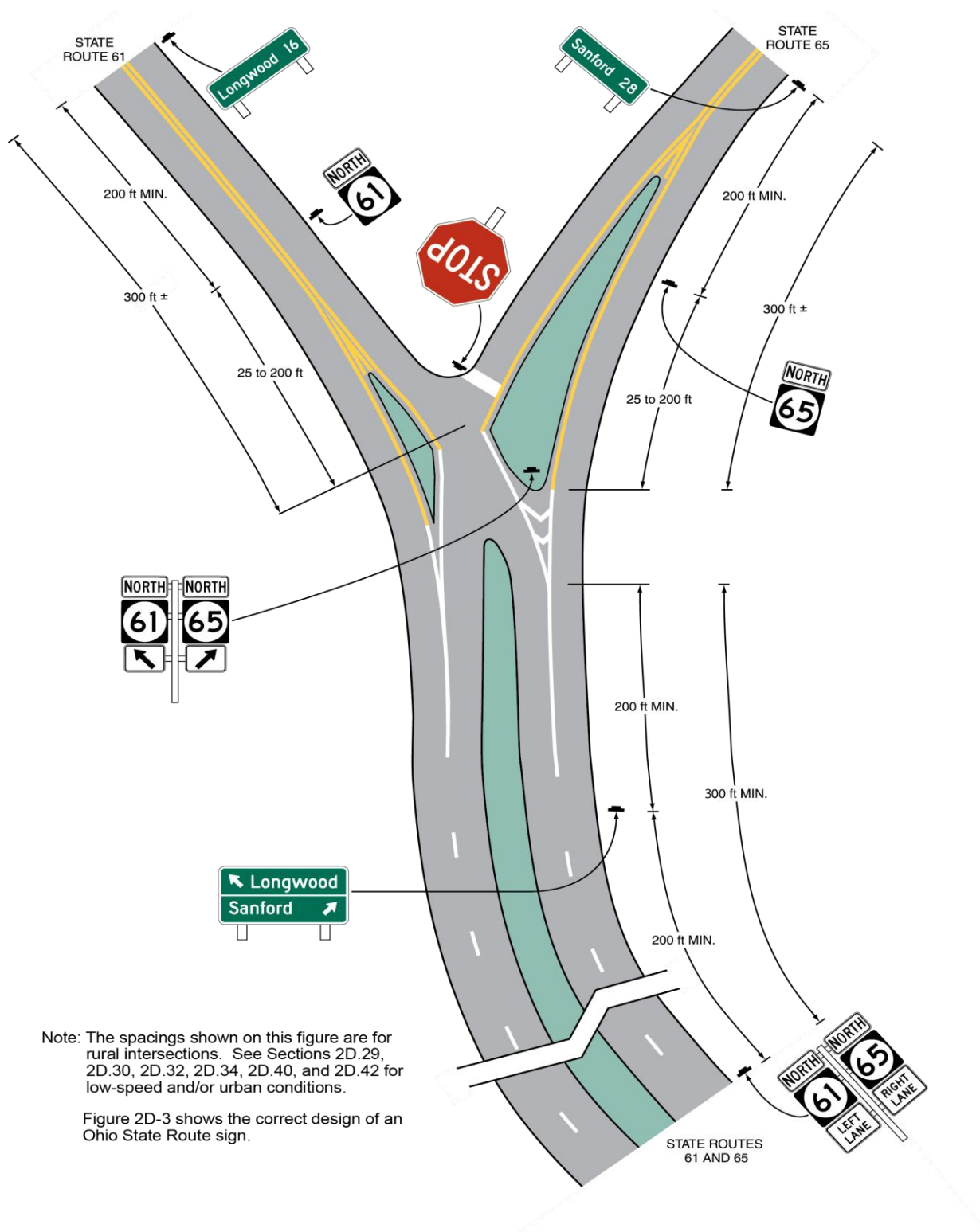

Note: The spacings shown on this figure are for rural intersections. See Sections 2D.29, 2D.30, 2D.32, 2D.34, 2D.40, and 2D.42 for low-speed and/or urban conditions.

Figure 2D-3 shows the correct design of an Ohio State Route sign.

- 03 *In urban areas, the Junction assembly should be installed in the block preceding the intersection. In urban areas where speeds are low, the Junction assembly should not be installed more than 300 feet in advance of the intersection.*
- 04 *In rural areas the Junction assembly should be installed at least 400 feet in advance of the intersection. In rural areas, the minimum distance between a Junction assembly and either a Destination sign or an Advance Route Turn assembly should be 200 feet.*
- 05 *Where speeds are high, greater spacings should be used.*

Option:

- 06 The Junction assembly may also be used with other numbered routes.
- 07 Where two or more routes are to be indicated, a single Junction auxiliary sign may be used for the assembly and all route signs grouped in a single mounting, or a Combination Junction (M2-2) sign (see Section 2D.14) may be used.

Section 2D.31 Advance Route Turn Assembly

Standard:

- 01 **An Advance Route Turn assembly shall consist of a route sign, an Advance Turn Arrow or word message auxiliary sign, and a Cardinal Direction auxiliary sign, if needed. It shall be installed in advance of an intersection where a turn must be made to remain on the indicated route.**

Option:

- 02 The Advance Route Turn assembly may be used to supplement the required Junction assembly in advance of intersecting routes.

Guidance:

- 03 *Where a multiple-lane highway approaches an interchange or intersection with a numbered route, the Advance Route Turn assembly should be used to pre-position turning vehicles in the correct lanes from which to make their turn.*

Option:

- 04 Lane Designation auxiliary signs (see Section 2D.27) may be used in Advance Route Turn Assemblies in place of the Advance Turn Arrow auxiliary signs where engineering judgment indicates that specific lane information associated with each route is needed and overhead signing is not practical and the designated lane is a mandatory movement lane. An assembly with the Lane Designation auxiliary signs may supplement or substitute for an assembly with Advance Turn Arrow auxiliary signs.

Guidance:

- 05 *In low-speed areas, the Advance Route Turn assembly should be installed not less than 200 feet in advance of the turn. In high-speed areas, the Advance Route Turn assembly should be installed not less than 300 feet in advance of the turn. In rural areas, the minimum distance between an Advance Route Turn assembly and either a Destination sign or a Junction assembly should be 200 feet.*

Standard:

- 06 **An assembly that includes an Advance Turn Arrow auxiliary sign shall not be placed where there is an intersection between it and the designated turn.**

Guidance:

- 07 *Sufficient distance should be allowed between the assembly and any preceding intersection that could be mistaken for the indicated turn.*

Section 2D.32 Directional Assembly

Standard:

- 01 **A Directional assembly shall consist of a Cardinal Direction auxiliary sign, if needed; a route sign; and a Directional Arrow auxiliary sign. The various uses of Directional assemblies shall be as provided in Items A through D:**

- A. Turn movements (indicated in advance by an Advance Route Turn assembly) shall be marked by a Directional assembly with a route sign displaying the number of the turning route and a single-headed arrow pointing in the direction of the turn.
- B. The beginning of a route (indicated in advance by a Junction assembly) shall be marked by a Directional assembly with a route sign displaying the number of that route and a single-headed arrow pointing in the direction of the route.
- C. An intersected route (indicated in advance by a Junction assembly) on a crossroad where the route is designated on both legs shall be designated by:
 - 1. Two Directional assemblies, each with a route sign displaying the number of the intersected route, a Cardinal Direction auxiliary sign, and a single-headed arrow pointing in the direction of movement on that route; or
 - 2. A Directional assembly with a route sign displaying the number of the intersected route and a double-headed arrow, pointing at appropriate angles to the left, right, or ahead.
- D. An intersected route (indicated in advance by a Junction assembly) on a side road or on a crossroad where the route is designated only on one of the legs shall be designated by a Directional assembly with a route sign displaying the number of the intersected route, a Cardinal Direction auxiliary sign, and a single-headed arrow pointing in the direction of movement on that route.

Guidance:

02 *Straight-through movements should be indicated by a Directional assembly with a route sign displaying the number of the continuing route and a vertical arrow. A Directional assembly should not be used for a straight-through movement in the absence of other assemblies indicating right or left turns, as the Confirming assembly sign beyond the intersection normally provides adequate guidance.*

03 *Directional assemblies should be located on the near right corner of the intersection. At major intersections and at Y or offset intersections, additional Directional assemblies should be installed on the far right or left corner to confirm the near-side assemblies. When the near-corner position is not practical for Directional assemblies, the far right corner should be the preferred alternative, with oversized signs, if necessary, for legibility. Where unusual conditions exist, the location of a Directional assembly should be determined by engineering judgment with the goal being to provide the best possible combination of view and safety.*

Support:

04 It is more important that guide signs be readable, and that the information and direction displayed thereon be readily understood, at the appropriate time and place than to be located with absolute uniformity.

05 Figure 2D-6 shows typical placements of Directional assemblies.

Section 2D.33 Combination Lane-Use/Destination Overhead Guide Sign (D15-1)

Option:

01 At complex intersection approaches involving multiple turn lanes and destinations, a Combination Lane-Use/Destination (D15-1) overhead guide sign that combines a lane-use regulatory sign with destination information such as a cardinal direction, a route number, a street name, and/or a place name may be used.

Support:

02 At such locations, the combined information on the D15-1 signs can be even more effective than separate lane-use and guide signs for conveying to unfamiliar drivers which lane or lanes to use for a particular destination.

03 Figure 2D-7 shows an example of a D15-1 sign that combines lane-use and route number information and an example of a D15-1 sign that combines lane-use and street name information.

Standard:

04 **The Combination Lane-Use/Destination (D15-1) overhead guide sign shall be used only where the designated lane is a mandatory movement lane. The D15-1 sign shall not be used for lanes with optional movements.**

05 **The D15-1 sign shall have a green background with a white border. As shown in Figure 2D-7, the lane-use sign (see Chapter 2B) shall be placed near the bottom of the sign and the destination**

Figure 2D-7. Destination and Distance Signs

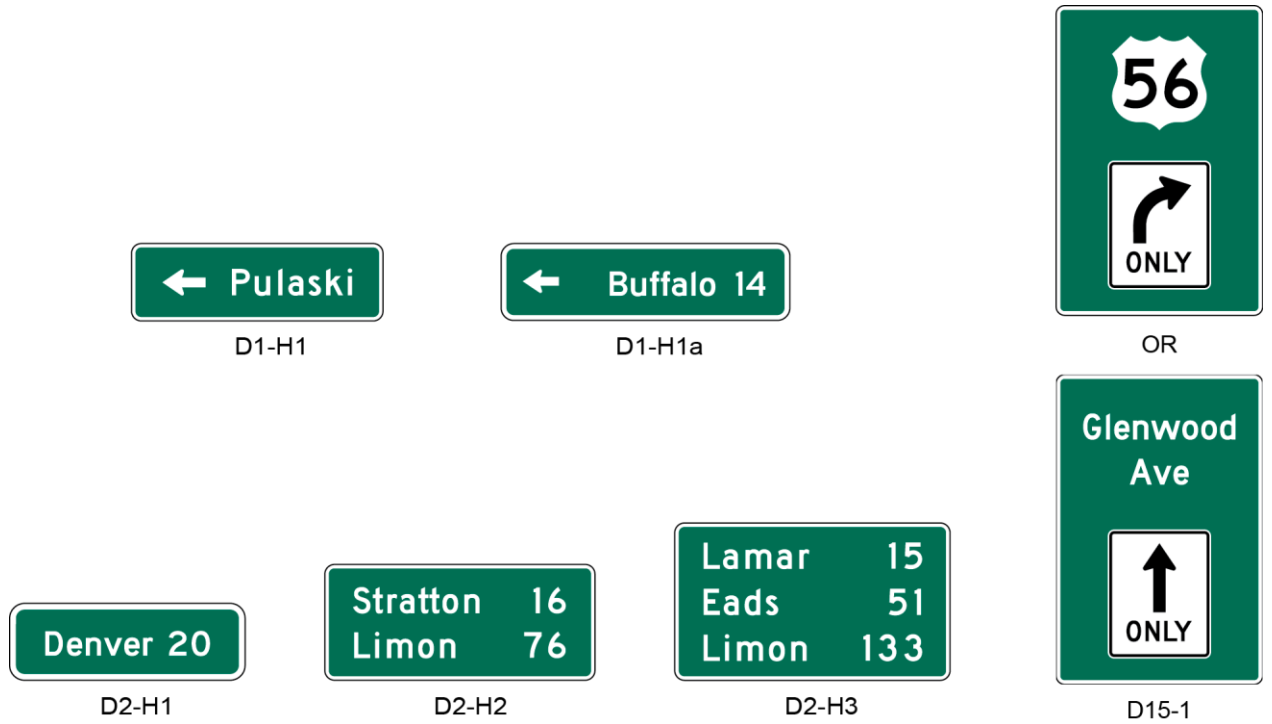

information shall be placed near the top of the sign. The D15-1 sign shall be located approximately over the center of the lane to which it applies.

Section 2D.34 Confirming or Reassurance Assemblies

Standard:

- 01 If used, **Confirming or Reassurance assemblies shall consist of a Cardinal Direction auxiliary sign and a route sign. Where the Confirming or Reassurance assembly is for an alternative route, the appropriate auxiliary sign for an alternative route (see Section 2D.16) shall also be included in the assembly.**

Guidance:

- 02 *A Confirming assembly should be installed just beyond intersections of numbered routes. It should be placed 25 to 200 feet beyond the far shoulder or curb line of the intersected highway.*
- 03 *If used, Reassurance assemblies should be installed between intersections in urban areas as needed, and beyond the built-up area of any incorporated city or town.*
- 04 *Route signs for either confirming or reassurance purposes should be spaced at such intervals as necessary to keep road users informed of their routes.*

Section 2D.35 Trailblazer Assembly

Support:

- 01 Trailblazer assemblies provide directional guidance to a particular road facility from other highways in the vicinity. This guidance is accomplished by installing Trailblazer assemblies at strategic locations to indicate the direction to the nearest or most convenient point of access. The use of the word TO indicates that the road or street where the sign is posted is not a part of the indicated route, and that a road user is merely being directed progressively to the route.

Standard:

- 02 **A Trailblazer assembly shall consist of a TO auxiliary sign, a route sign for a numbered or named highway (see Section 2D.53) or an Auto Tour Route sign (see Section 2H.07), and a single-headed**

Directional Arrow auxiliary sign pointing in the direction leading to the route. Where the Trailblazer assembly is for an alternative route, the appropriate auxiliary sign for an alternative route (see Section 2D.16) shall also be included in the assembly.

Option:

03 A Cardinal Direction auxiliary sign may be used with a Trailblazer assembly.

Guidance:

04 *The TO auxiliary sign, Cardinal Direction auxiliary sign, and Directional Arrow auxiliary sign should be of the standard size provided for auxiliary signs of their respective type. The route sign should be the size provided in Section 2D.11.*

Option:

05 Trailblazer assemblies may be installed with other Route Sign assemblies, or alone, in the immediate vicinity of the designated facilities.

Section 2D.36 Destination and Distance Signs

Support:

01 In addition to guidance by route numbers, it is desirable to supply the road user information concerning the destinations that can be reached by way of numbered or unnumbered routes. This is done by means of Destination signs and Distance signs.

Option:

02 Route shields and cardinal directions may be included on the Destination sign with the destinations and arrows.

Guidance:

03 *If route shields and cardinal directions are included on a Destination sign, the height of the Route shields should be at least two times the height of the upper-case letters of the principal legend and not less than 18 inches, and the cardinal directions should be in all upper-case letters that are at least the minimum height specified for these signs.*

Section 2D.37 Destination Signs (D1 Series)

Standard:

01 **Except on approaches to interchanges (see Section 2D.45), the Destination (D1 series) sign (see Figure 2D-7), if used, shall be a horizontal rectangle displaying the name of a city, town, village, or other traffic generator, and a directional arrow.**

Guidance:

02 *In order to control proliferation of destination signs, each responsible jurisdiction should establish a policy similar to the traffic generator policy established by the Ohio Department of Transportation (ODOT) in Part 2 of ODOT's "Traffic Engineering Manual" (see Section 1A.11).*

Option:

03 The distance (see Section 2D.41) to the place named may also be displayed on the Destination sign (see Figure 2D-7). If several destinations are to be displayed at a single point, the several names may be placed on a single sign with an arrow (and the distance, if desired) for each name. If more than one destination lies in the same direction, a single arrow may be used for such a group of destinations.

Guidance:

04 *Adequate separation should be made between any destinations or group of destinations in one direction and those in other directions by suitable design of the arrow, spacing of lines of legend, heavy lines entirely across the sign, or separate signs.*

Support:

05 Separation of destinations by direction by the use of a horizontal separator line can enhance the readability of a Destination sign by relating an arrow and its corresponding destination(s) and by eliminating the need for multiple arrows that point in the same direction and excessive space between lines of legend.

Standard:

- 06 **Except as otherwise provided in this Manual, an arrow pointing to the right shall be at the extreme right of the sign, and an arrow pointing left or up shall be at the extreme left. The distance numerals, if used, shall be placed to the right of the destination names.**

Option:

- 07 An arrow pointing up may be placed at the extreme right of the sign when the sign is mounted to the left of the traffic to which it applies.

Guidance:

- 08 *Unless a sloping arrow will convey a clearer indication of the direction to be followed, the directional arrows should be horizontal or vertical.*
- 09 *If several individual name signs are assembled into a group, all signs in the assembly should be of the same horizontal width.*
- 10 *Destination signs should be used:*
- A. *At the intersections of U.S. or State numbered routes with Interstate, U.S., or State numbered routes; and*
 - B. *At points where they serve to direct traffic from U.S. or State numbered routes to the business section of towns, or to other destinations reached by unnumbered routes.*

Standard:

- 11 **Where a total of three or fewer destinations are provided on the Advance Guide (see Section 2E.33) and Supplemental Guide (see Section 2E.35) signs, no more than three destination names shall be used on a Destination sign. Where four destinations are provided by the Advance Guide and Supplemental Guide signs, no more than four destination names shall be used on a Destination sign.**

Guidance:

- 12 *If space permits, four destinations should be displayed as two separate signs at two separate locations.*

Option:

- 13 Where space does not permit, or where all four destinations are in one direction, a single sign may be used. Where a single sign is used and all destinations are in the same direction, the arrow may be placed below the destinations for the purpose of enhancing the conspicuity of the arrow.

Standard:

- 14 **Where a single four-name sign assembly is used, a heavy line entirely across the sign or separate signs shall be used to separate destinations by direction.**

Guidance:

- 15 *The closest destination lying straight ahead should be at the top of the sign or assembly, and below it the closest destinations to the left and to the right, in that order. The destination displayed for each direction should ordinarily be the next County seat or the next principal city, rather than a more distant destination. In the case of overlapping routes, only one destination should be displayed in each direction for each route.*

Standard:

- 16 **If more than one destination is displayed in the same direction, the name of a nearer destination shall be displayed above the name of a destination that is further away.**

Support:

- 17 The SDMM (see Section 1A.11) contains designs for the signs shown here and variations not depicted, such as provisions for two-line legends for long names.

- 18 For additional information about destination guide signs for recreational and cultural interest areas, see Chapter 2M.

Section 2D.38 Destination Signs at Circular Intersections**Standard:**

- 01 **Destination signs that are used at circular intersections shall comply with the provisions of Section 2D.37, except as provided in this Section.**

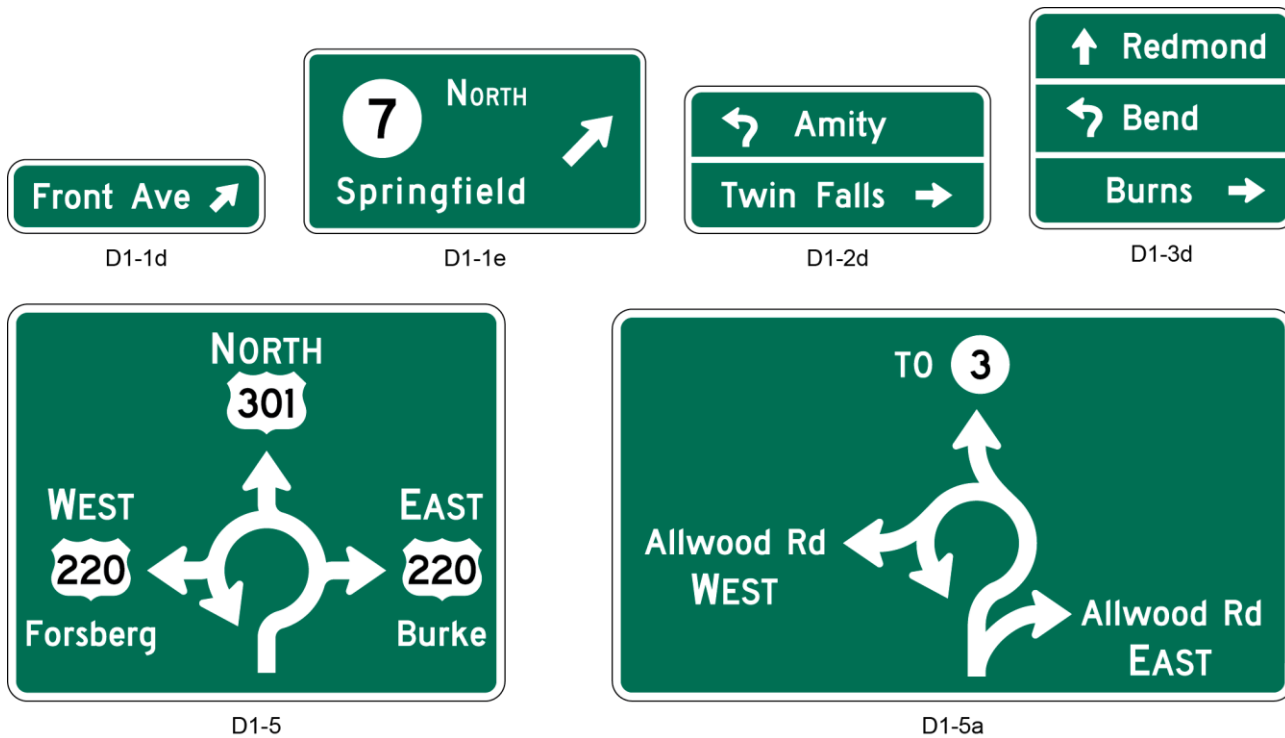
Figure 2D-8. Destination Signs for Roundabouts

Note: Figures 2D-3 and 2D-4 show the correct design of an Ohio State Route sign.

Option:

- 02 Exit destination (D1-1d, D1-1e) signs (see Figure 2D-8) with diagonal upward-pointing arrows or
 Directional assemblies (see Section 2D.32) may be used to designate a particular exit from a circular
 intersection.
- 03 Exit destination (D1-2d, D1-3d) signs (see Figure 2D-8) with curved-stem arrows may be used on
 approaches to circular intersections to represent the left-turn movements.
- 04 Curved-stem arrows on circular intersection destination signs may point in diagonal directions to depict
 the location of an exit relative to the approach roadway and entry into the intersection.
- 05 Exit destination (D1-5 or D1-5a) signs (see Figure 2D-8) with a diagram of the circular intersection may
 be used on approaches to circular intersections.

Guidance:

- 06 *If curved-stem arrows are used on destination signs, then this arrow type should also be used
 consistently on any regulatory lane-use signs (see Chapter 2B), Directional assemblies (see Section 2D.32),
 and pavement markings (see Part 3) for a particular destination or movement.*

Support:

- 07 Figure 2D-9 illustrates examples of guide signing for circular intersections.
- 08 Diagrammatic guide signs might be preferable where space is available and where the geometry of the
 circular intersection is non-typical, such as where more than four legs are present or where the legs are not at
 approximately 90-degree angles to each other.

Standard:

- 09 **If used, diagrammatic guide signs for circular intersections shall not depict the number of lanes
 within the intersection circulatory roadway, or on its approaches or exits, through the use of lane lines,
 multiple arrow shafts for the same movement, or other methods.**

Support:

- 10 Chapter 2B contains information regarding regulatory signs at circular intersections, Chapter 2C contains
 information regarding warning signs at circular intersections, and Chapter 3C contains information regarding
 pavement markings at circular intersections.

Figure 2D-9. Examples of Guide Signs for Roundabouts (Sheet 1 of 2)

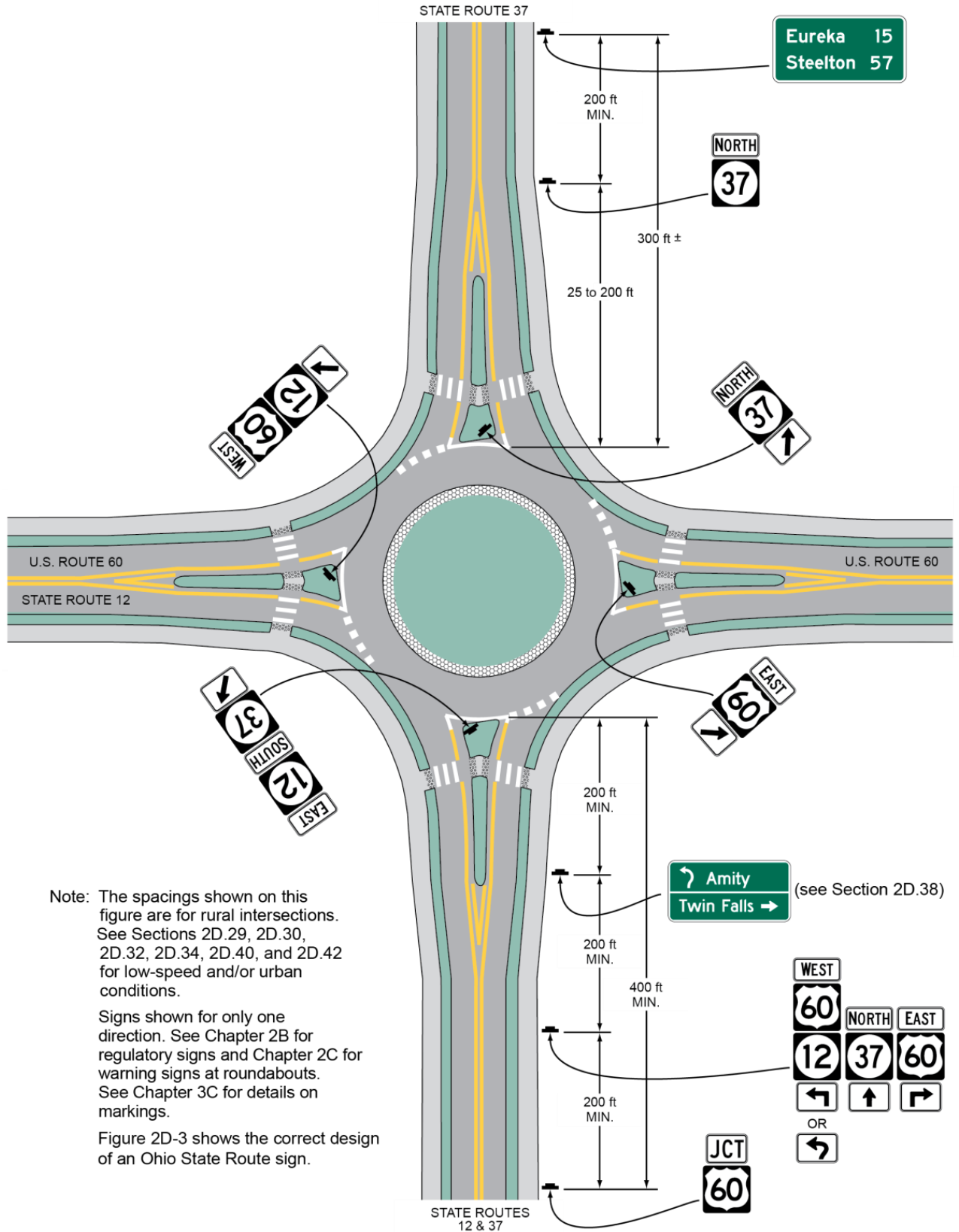
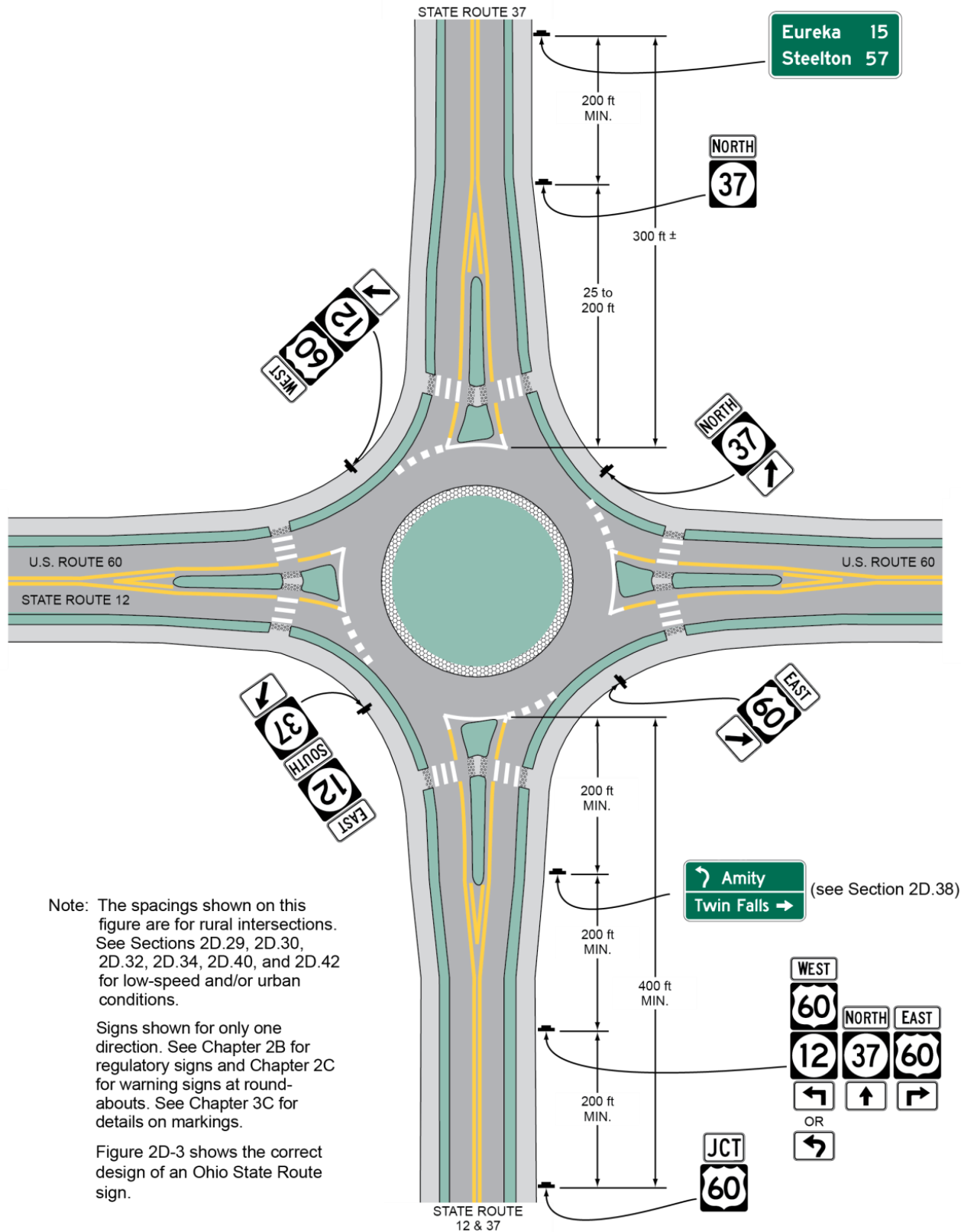

Figure 2D-9. Examples of Guide Signs for Roundabouts (Sheet 2 of 2)



Section 2D.39 Destination Signs at Jughandles

Standard:

- 01 **Destination signs that are used at jughandles shall comply with the provisions of Section 2D.37, except as provided in this Section.**

Option:

- 02 If engineering judgment indicates that standard destination signs alone are insufficient to direct road users to their destinations at a jughandle, a diagrammatic guide sign depicting the appropriate geometry may be used to supplement the normal destination signs.

Support:

- 03 Section 2B.27 contains information regarding regulatory signs for jughandle turns. Figure 2B-9 shows examples of regulatory and destination guide signing for various types of jughandle turns.

Section 2D.40 Location of Destination Signs

Guidance:

- 01 *When used in high-speed areas, Destination signs should be located 200 feet or more in advance of the intersection, and following any Junction or Advance Route Turn assemblies that might be required. In rural areas, the minimum distance between a Destination sign and either an Advance Route Turn assembly or a Junction assembly should be 200 feet.*

Option:

- 02 In urban areas, shorter advance distances may be used.

- 03 Because the Destination sign is of lesser importance than the Junction, Advance Route Turn, or Directional assemblies, the Destination sign may be eliminated when sign spacing is critical.

Support:

- 04 Figure 2D-6 shows typical placements of Destination signs.

Section 2D.41 Distance Signs (D2 Series)

Standard:

- 01 **If used, the Distance (D2-H1 through D2-H3) sign (see Figure 2D-7) shall be a horizontal rectangle of a size appropriate for the required legend, carrying the names of no more than three cities, towns, junctions, or other traffic generators, and the distance (to the nearest mile) to those places.**

- 02 **The distance numerals shall be placed to the right of the destination names as shown in Figure 2D-7.**

Guidance:

- 03 *The distance displayed should be selected on a case-by-case basis by the jurisdiction that owns the road. A well-defined central area or central business district should be used where one exists. In other cases, the layout of the community should be considered in relation to the highway being signed and the decision based on where it appears that most drivers would feel that they are in the center of the community in question.*

- 04 *The top name on the Distance sign should be that of the next place on the route having a post office or a railroad station, a route number or name of an intersected highway, or any other significant geographical identity. The bottom name on the sign should be that of the next major destination or control city (see Section 2E.13 for more information about control cities). If three destinations are displayed, the middle line should be used to indicate communities of general interest along the route or important route junctions.*

Option:

- 05 The choice of names for the middle line may be varied on successive Distance signs to give road users additional information concerning communities served by the route.

Guidance:

- 06 *The control city (see Section 2E.13) should remain the same on all successive Distance signs throughout the length of the route until that city is reached.*

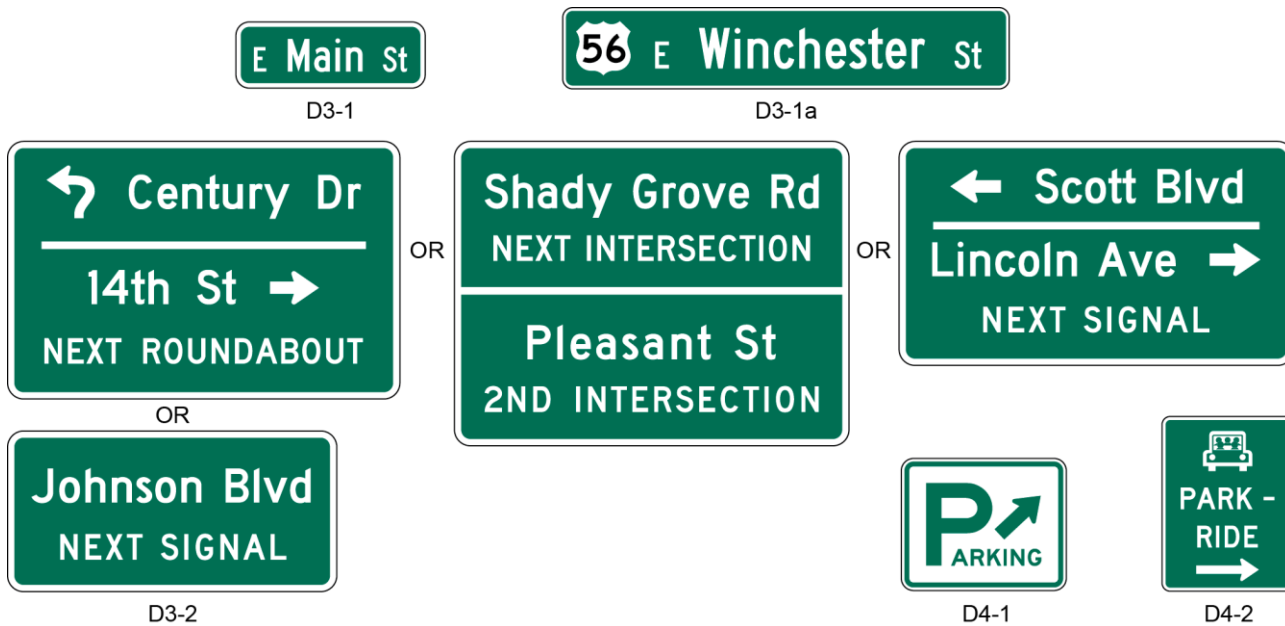
Figure 2D-10. Street Name and Parking Signs

Option:

- 07 If more than one distant point may properly be designated, such as where the route divides at some distance ahead to serve two destinations of similar importance, and if these two destinations cannot appear on the same sign, the two names may be alternated on successive signs.
- 08 On a route continuing into another State, destinations in the adjacent State may be displayed.

Section 2D.42 Location of Distance Signs

Guidance:

- 01 *If used, Distance signs should be installed on important routes leaving municipalities just outside the municipal limits or at the edge of the built-up area if it extends beyond the limits.*
- 02 *Where overlapping routes separate a short distance from the municipal limits, the Distance sign at the municipal limits should be omitted. The Distance sign should be installed approximately 300 feet beyond the separation of the two routes.*
- 03 *Where, just outside of an incorporated municipality, two routes are concurrent and continue concurrently to the next incorporated municipality, the top name on the Distance sign should be that of the place where the routes separate; the bottom name should be that of the city to which the greater part of the through traffic is destined.*
- 04 *If used in rural areas, Distance signs should be placed approximately 300 feet beyond intersections of numbered routes and a minimum of 200 feet beyond confirming Route Assemblies.*

Support:

- 05 Figure 2D-6 shows typical placements of Distance signs.

Section 2D.43 Street Name Signs (D3-1 or D3-1a)

Guidance:

- 01 *Street Name (D3-1 or D3-1a) signs (see Figure 2D-10) should be installed in urban areas at all street intersections regardless of other route signs that might be present and should be installed in rural areas to identify important roads that are not otherwise signed.*

Option:

- 02 For streets that are part of a U.S., State, or county numbered route, a D3-1a Street Name sign (see Figure 2D-10) that incorporates a route shield may be used to assist road users who might not otherwise be able to associate the name of the street with the route number.

Table 2D-2. Recommended Minimum Letter Heights on Street Name Signs

Type of Mounting	Types of Street or Highway	Speed Limit	Recommended Minimum Letter Height	
			Initial Upper-Case	Lower-Case
Overhead	All types	All speed limits	12 inches	9 inches
Post-Mounted	Multi-lane	More than 40 mph	8 inches	6 inches
Post-Mounted	Multi-lane	40 mph or less	6 inches	4.5 inches
Post-Mounted	2-lane	All speed limits	6 inches*	4.5 inches*

* On local two-lane streets with speed limits of 25 mph or less, 4-inch initial upper-case letters with 3-inch lower-case letters may be used.

Standard:

03 **The lettering for names of streets and highways on Street Name signs shall be composed of a combination of lower-case letters with initial upper-case letters (see Section 2A.13).**

Guidance:

04 *Lettering on post-mounted Street Name signs should be composed of initial upper-case letters at least 6 inches in height and lower-case letters at least 4.5 inches in height.*

05 *On multi-lane streets with speed limits greater than 40 mph, the lettering on post-mounted Street Name signs should be composed of initial upper-case letters at least 8 inches in height and lower-case letters at least 6 inches in height.*

Option:

06 For local roads with speed limits of 25 mph or less, the lettering on post-mounted Street Name signs may be composed of initial upper-case letters at least 4 inches in height and lower-case letters at least 3 inches in height.

Guidance:

07 *If overhead Street Name signs are used, the lettering should be composed of initial upper-case letters at least 12 inches in height and lower-case letters at least 9 inches in height.*

Support:

08 The recommended minimum letter heights for Street Name signs are summarized in Table 2D-2.

Option:

09 Supplementary lettering to indicate the type of street (such as Street, Avenue, or Road) or the section of the city (such as NW) on the D3-1 and D3-1a signs may be in smaller lettering, composed of initial upper-case letters at least 3 inches in height and lower-case letters at least 2.25 inches in height. Conventional abbreviations (see Section 1A.15) may be used except for the street name itself.

10 A pictograph (see definition in Section 1A.13) may be used on a D3-1 sign.

Standard:

11 **Pictographs shall not be displayed on D3-1a or Advance Street Name (D3-2) signs (see Section 2D.44).**

12 **If a pictograph is used on a D3-1 sign, the height and width of the pictograph shall not exceed the upper-case letter height of the principal legend of the sign.**

Guidance:

13 *The pictograph should be positioned to the left of the street name.*

Standard:

14 **The Street Name sign shall be retroreflective or illuminated to show the same shape and similar color both day and night. The color of the legend (and border, if used) shall contrast with the background color of the sign.**

Option:

15 The border may be omitted from a Street Name sign.

16 An alternative background color other than the normal guide sign color of green may be used for Street Name (D3-1 or D3-1a) signs where the highway agency determines this is necessary to assist road users in determining jurisdictional authority for roads.

Standard:

17 **Alternative background colors shall not be used for Advance Street Name (D3-2) signs (see Section 2D.44).**

18 **The only acceptable alternative background colors for Street Name (D3-1 or D3-1a) signs shall be blue, brown, or white. Regardless of whether green, blue, or brown is used as the background color for Street Name (D3-1 or D3-1a) signs, the legend (and border, if used) shall be white. For Street Name signs that use a white background, the legend (and border, if used) shall be black.**

Guidance:

19 *An alternative background color for Street Name signs, if used, should be applied to the Street Name (D3-1 or D3-1a) signs on all roadways under the jurisdiction of a particular highway agency.*

20 *In business or commercial areas and on principal arterials, Street Name signs should be placed at least on diagonally opposite corners. In residential areas, at least one Street Name sign should be mounted at each intersection. Signs naming both streets should be installed at each intersection. They should be mounted with their faces parallel to the streets they name.*

Option:

21 To optimize visibility, Street Name signs may be mounted overhead. Street Name signs may also be placed above a regulatory or STOP or YIELD sign with no required vertical separation.

Guidance:

22 *In urban or suburban areas, especially where Advance Street Name signs for signalized and other major intersections are not used, the use of overhead Street Name signs should be strongly considered.*

Option:

23 At intersection crossroads where the same road has two different street names for each direction of travel, both street names may be displayed on the same sign along with directional arrows.

Support:

24 Information regarding the use of street names on supplemental plaques for use with intersection-related warning signs is contained in Section 2C.58.

Section 2D.44 Advance Street Name Signs (D3-2)

Support:

01 Advance Street Name (D3-2) signs (see Figure 2D-10) identify an upcoming intersection. Although this is often the next intersection, it could also be several intersections away in cases where the next signalized intersection is referenced.

Standard:

02 **Advance Street Name (D3-2) signs, if used, shall supplement rather than be used instead of the Street Name (D3-1) signs at the intersection.**

Option:

03 Advance Street Name (D3-2) signs may be installed in advance of signalized or unsignalized intersections to provide road users with advance information to identify the name(s) of the next intersecting street to prepare for crossing traffic and to facilitate timely deceleration and/or lane changing in preparation for a turn.

Guidance:

04 *On arterial highways in rural areas, Advance Street Name signs should be used in advance of all signalized intersections and in advance of all intersections with exclusive turn lanes.*

05 *In urban areas, Advance Street Name signs should be used in advance of all signalized intersections on major arterial streets, except where signalized intersections are so closely spaced that advance placement of the signs is impractical.*

06 *The heights of the letters on Advance Street Name signs should be the same as those used for Street Name signs (see Section 2D.43)*

Standard:

07 **If used, Advance Street Name signs shall have a white legend and border on a green background.**

08 **If used, Advance Street Name signs shall provide the name(s) of the intersecting street(s) on the top line(s) of the legend and the distance to the intersecting streets or messages such as NEXT SIGNAL, NEXT INTERSECTION, NEXT ROUNDABOUT, or directional arrow(s) on the bottom line of the legend.**

09 **Pictographs shall not be displayed on Advance Street Name signs.**

Option:

10 Directional arrow(s) may be placed to the right or left of the street name or message such as NEXT SIGNAL, as appropriate, rather than on the bottom line of the legend. Curved-stem arrows may be used on Advance Street Name signs on approaches to circular intersections.

11 For intersecting crossroads where the same road has a different street name for each direction of travel, the different street names may be displayed on the same Advance Street Name sign along with directional arrows.

12 In advance of two closely spaced intersections where it is not practical to install separate Advance Street Name signs, the Advance Street Name sign may include the street names for both intersections along with appropriate supplemental legends for both street names, such as NEXT INTERSECTION, 2ND INTERSECTION, or NEXT LEFT and NEXT RIGHT, or directional arrows.

Guidance:

13 *If two street names are used on the Advance Street Name sign, the street names should be displayed in the following order:*

- A. *For a single intersection where the same road has a different street name for each direction of travel, the name of the street to the left should be displayed above the name of the street to the right; or*
- B. *For two closely-spaced intersections, the name of the first street encountered should be displayed above the name of the second street encountered, and the arrow associated with the second street encountered should be an advance arrow, such as the arrow shown on the W16-6P arrow plaque (see Figure 2C-12).*

Option:

14 An Advance Street Name (W16-8P or W16-8aP) plaque (see Section 2C.58) with black legend on a yellow background, installed supplemental to an Intersection (W2 series) or Advance Traffic Control (W3 series) warning sign may be used instead of an Advance Street Name guide sign.

Section 2D.45 Signing on Conventional Roads on Approaches to Interchanges

Support:

01 Because there are a number of different ramp configurations that are commonly used at interchanges with conventional roads, drivers on the conventional road cannot reliably predict whether they will be required to turn left or right in order to enter the correct ramp to access the freeway or expressway in the desired direction of travel. Consistently applied signing for conventional road approaches to freeway or expressway interchanges is highly desirable.

Standard:

02 **On multi-lane conventional roads approaching an interchange, guide signs shall be provided to identify which direction of turn is to be made and/or which specific lane to use for ramp access to each direction of the freeway or expressway.**

Guidance:

03 *The signing of conventional roads with one lane of traffic approaching an interchange should consist of a sequence containing the following signs (see Figure 2D-11):*

- A. *Junction Assembly*

Figure 2D-11. Example of Interchange Crossroad Signing for a One-Lane Approach



- B. Destination sign
- C. Directional Assembly or Entrance Direction sign for the first ramp
- D. Advance Route Turn Assembly or Advance Entrance Direction sign with an advance turn arrow
- E. Directional Assembly or Entrance Direction sign for the second ramp

Standard:

04 **If used, the Entrance Direction sign shall consist of a white legend and border on a green background. It shall contain the freeway or expressway route shield(s), cardinal direction, and directional arrow(s).**

Option:

05 The Entrance Direction sign may contain a destination(s) and/or an action message such as NEXT RIGHT.

06 At minor interchanges, the following sequence of signs may be used (see Figure 2D-12):

- A. Junction Assembly
- B. Directional Assembly for the first ramp
- C. Directional Assembly for the second ramp

Guidance:

07 *On multi-lane conventional roads approaching an interchange, the sign sequence should contain the following signs (see Figures 2D-13 through 2D-15):*

- A. Junction Assembly
- B. Advance Entrance Direction sign(s) for both directions (if applicable) of travel on the freeway or expressway
- C. Entrance Direction sign for first ramp
- D. Advance Turn Assembly
- E. Entrance Direction sign for the second ramp

Figure 2D-12. Example of Minor Interchange Crossroad Signing

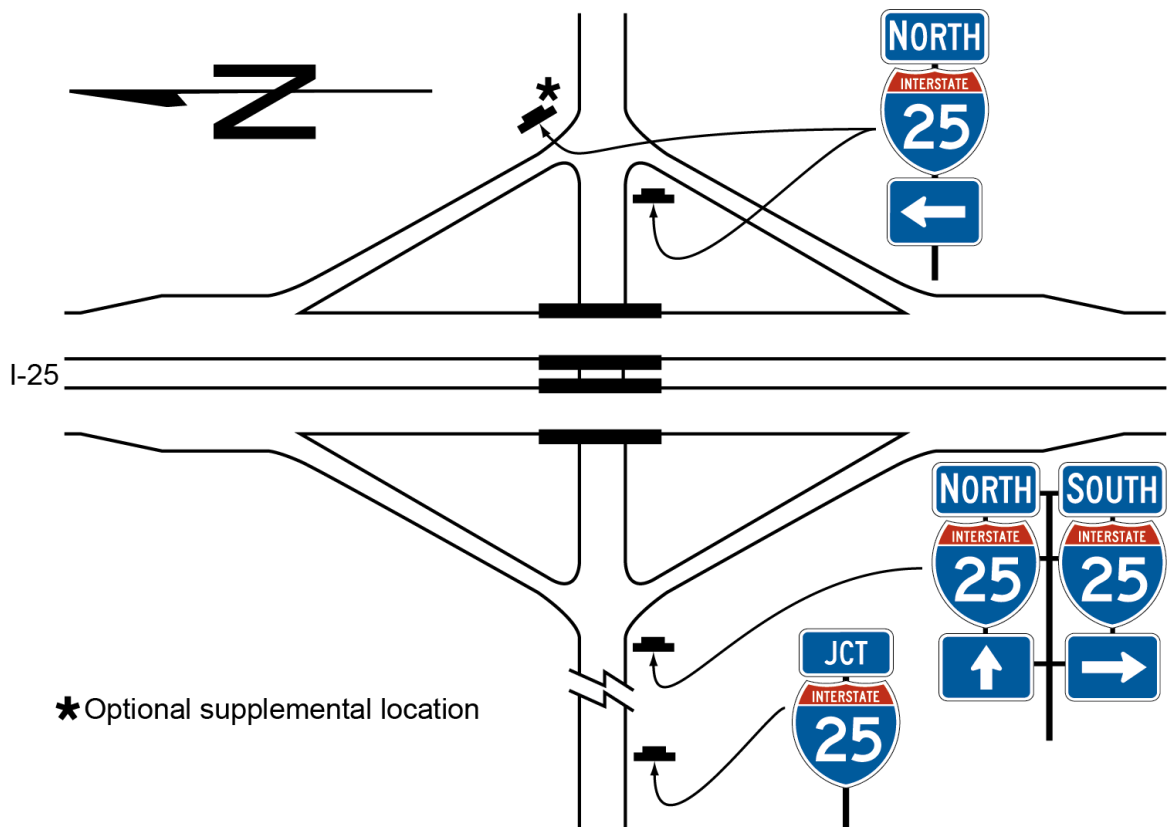

Figure 2D-13. Examples of Multi-Lane Crossroad Signing for a Diamond Interchange

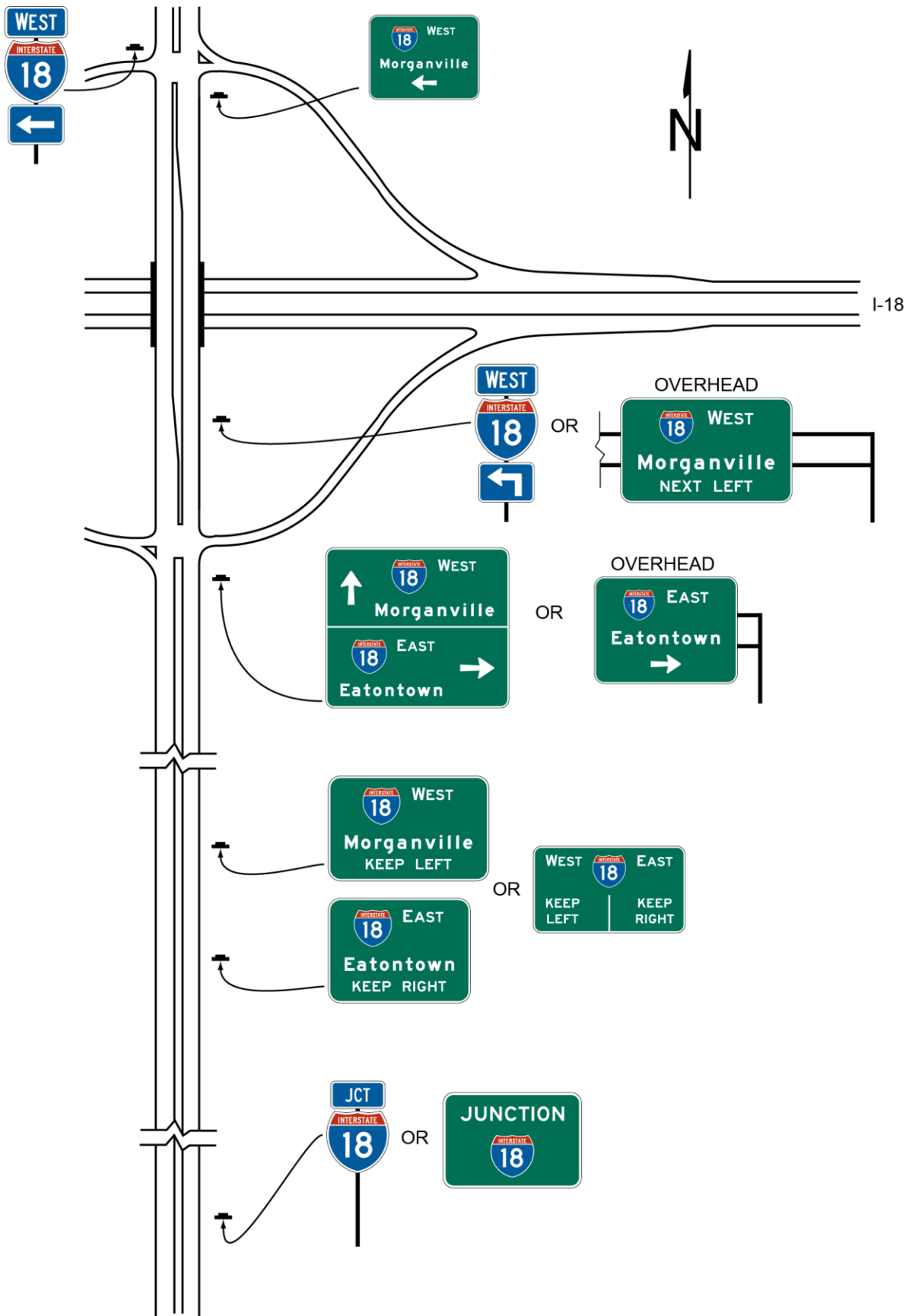

Figure 2D-14. Examples of Multi-Lane Crossroad Signing for a Partial Cloverleaf Interchange

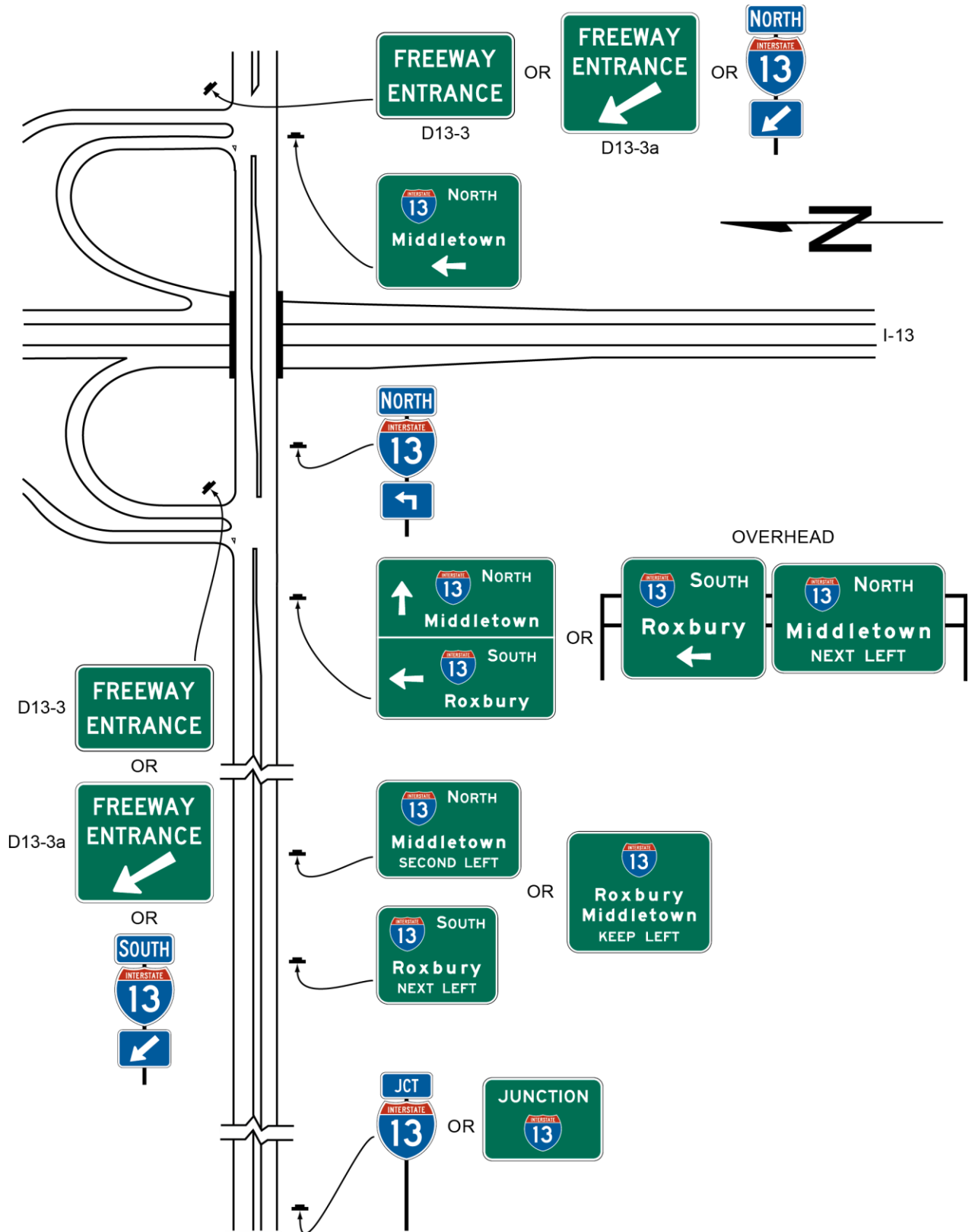

Figure 2D-15. Examples of Multi-Lane Crossroad Signing for a Cloverleaf Interchange

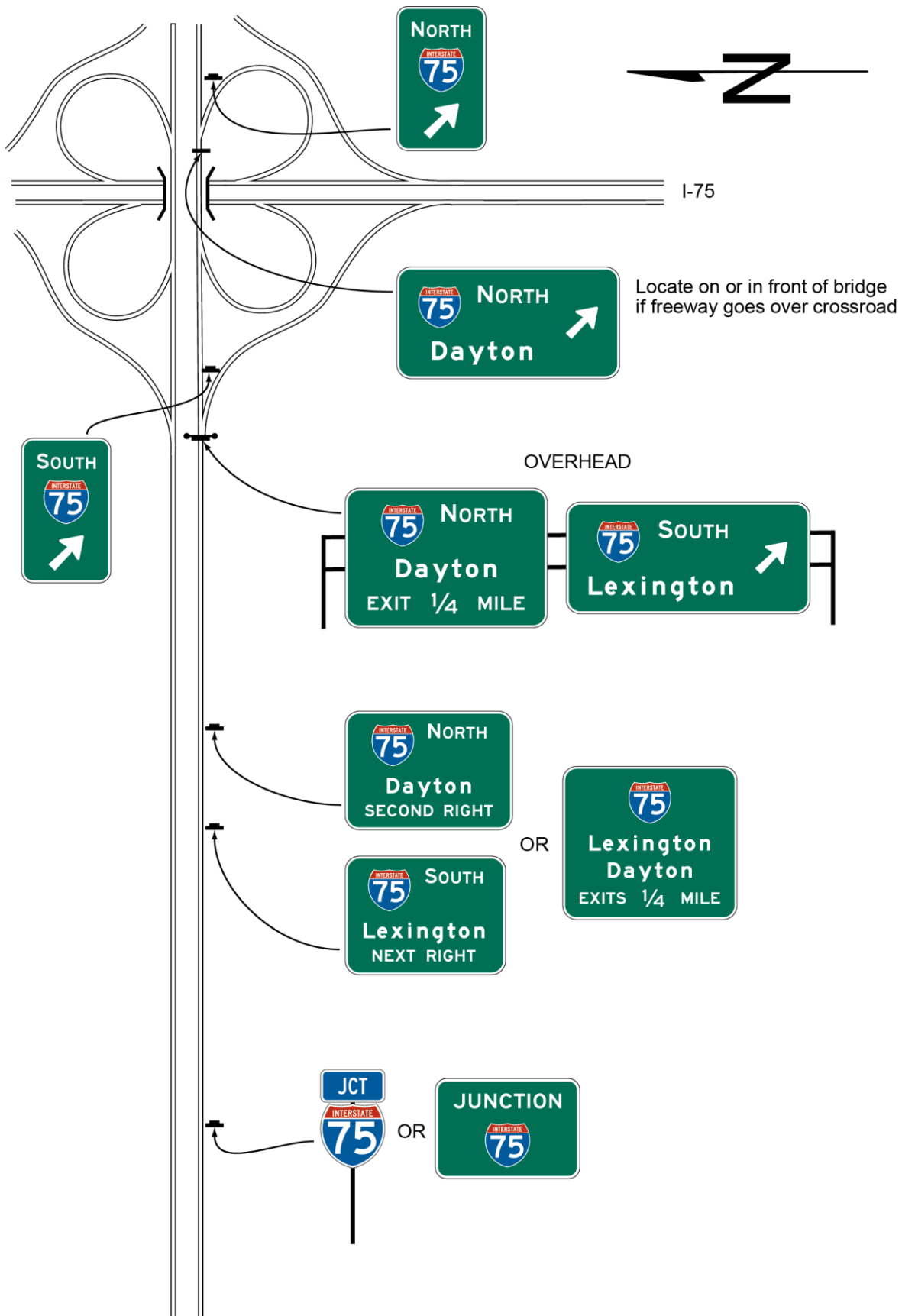
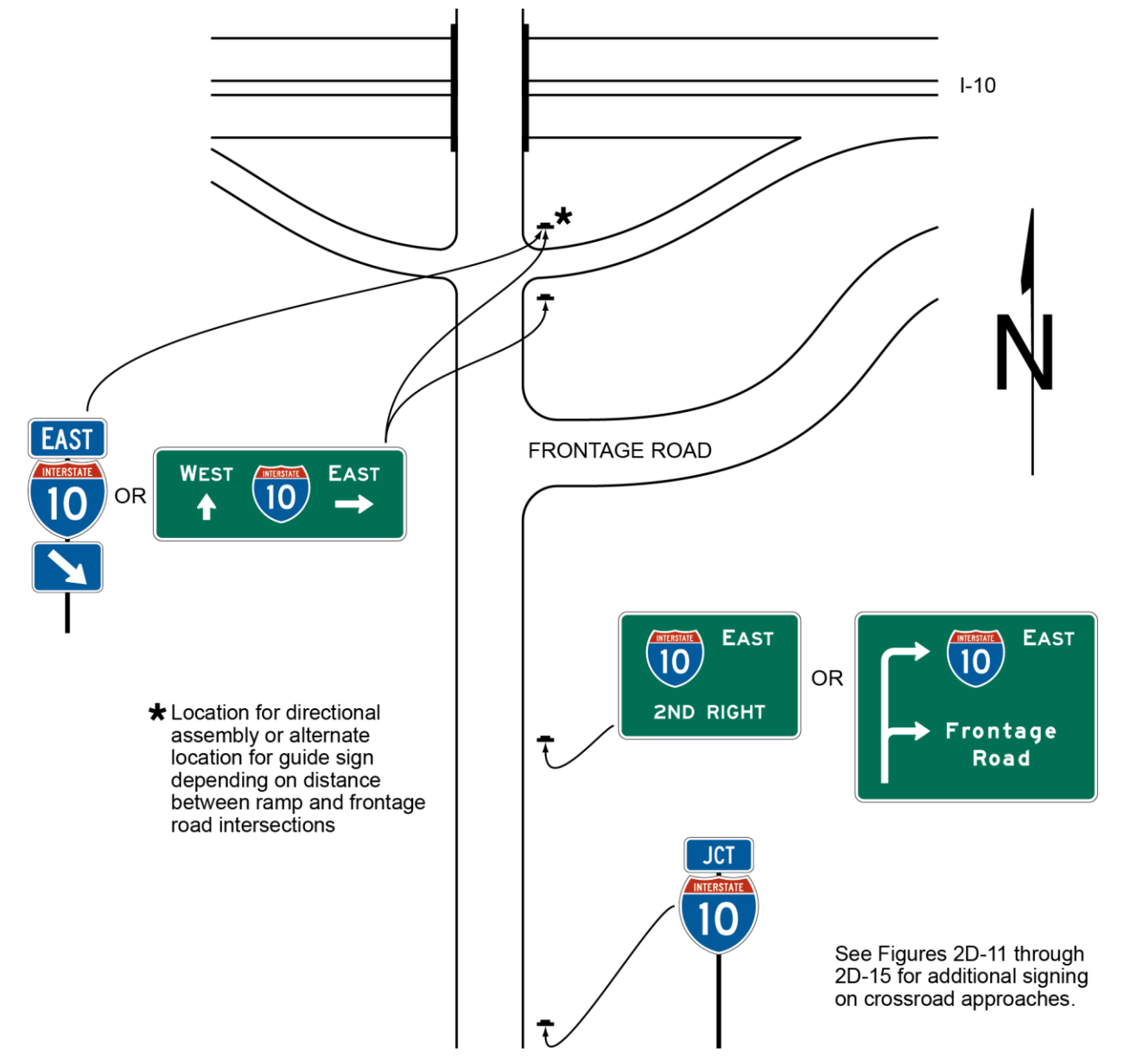

Figure 2D-16. Example of Crossroad Signing for an Entrance Ramp with a Nearby Frontage Road



Support:

- 08 Advance Entrance Direction signs are used to direct road users to the appropriate lane(s).

Standard:

- 09 **The Advance Entrance Direction sign shall consist of a white legend and border on a green background. It shall contain the freeway or expressway route shield(s) and cardinal direction(s).**

Option:

- 10 The Advance Entrance Direction sign may have destinations, directional arrows, and/or an action message such as KEEP LEFT, NEXT LEFT, or SECOND RIGHT. Signs in this sequence may be mounted overhead to improve visibility as shown in Figures 2D-13 through 2D-15.

Support:

- 11 A post-mounted Advance Entrance Direction diagrammatic guide sign (see Figure 2D-16), within the sequence of approach guide signing described in Paragraphs 3, 6, and 7, might be helpful in depicting the location of a freeway or expressway entrance ramp that is in close proximity to an intervening intersection on

the same side of the approach roadway and where signing for only the ramp might cause confusion to road users.

Standard:

- 12 **If used, the post-mounted Advance Entrance Direction diagrammatic guide sign shall display only the two successive turns from the same side of the roadway, one of which shall be the entrance ramp. The post-mounted Advance Entrance Direction sign shall depict only the successive turns and shall not depict lane use with lane lines, multiple arrow shafts for the approach roadway, action messages, or other representations.**

Support:

- 13 Section 2D.46 contains information regarding the use of a Directional assembly or a FREEWAY ENTRANCE sign to mark the entrance to a freeway or expressway at the far corner of an intersection.

Section 2D.46 Freeway Entrance Signs (D13-3, D13-3a)

Option:

- 01 FREEWAY ENTRANCE (D13-3) signs or FREEWAY ENTRANCE with downward pointing diagonal arrow (D13-3a) signs (see Figure 2D-14) may be used on entrance ramps near the crossroad to inform road users of the freeway or expressway entrance, as appropriate.
- 02 The D13-3 and D13-3a signs may display an alternate legend in place of FREEWAY, such as EXPRESSWAY or PARKWAY, as appropriate, or may display the name of an unnumbered highway.
- 03 A Directional assembly (see Section 2D.32) with a downward pointing diagonal arrow auxiliary (M6-2a) sign (see Section 2D.28) may be used at the far left-hand corner of an intersection with a freeway or expressway entrance ramp as an alternative to the D13-3a sign, facing left-turning traffic on the conventional road approach to indicate the immediate point of entry to the freeway or expressway and distinguish the entrance ramp from an adjoining exit ramp terminal at the same intersection with the conventional road (see Figure 2D-14). A similar Directional assembly may be used at the far right-hand corner of an intersection with a freeway or expressway entrance ramp where the entrance ramp and a crossroad or side road follow one another in close succession on the conventional road approach and the point of entry to the freeway or expressway might be difficult for the road user to distinguish from the crossroad or side road on the conventional road approach (see Figure 2D-14).

Support:

- 04 Section 2B.41 contains information regarding the use of regulatory signs to deter wrong-way movements at intersections of freeway or expressway ramps with conventional roads, and in the area where entrance ramps intersect with the mainline lanes.

Section 2D.47 Parking Area Guide Sign (D4-1)

Option:

- 01 The Parking Area (D4-1) guide sign (see Figure 2D-10) may be used to show the direction to a nearby public parking area or parking facility.

Standard:

- 02 **If used, the Parking Area (D4-1) guide sign shall be a horizontal rectangle with a standard size of 30 x 24 inches, or with a smaller size of 18 x 15 inches for minor, low-speed streets. It shall carry the word PARKING, with the letter P five times the height of the remaining letters, and a directional arrow. The legend and border shall be green on a retroreflectorized white background.**

Guidance:

- 03 *If used, the Parking Area guide sign should be installed on major thoroughfares at the nearest point of access to the parking facility and where it can advise drivers of a place to park. The sign should not be used more than four blocks from the parking area.*

Section 2D.48 PARK - RIDE Sign (D4-2)

Option:

- 01 PARK - RIDE (D4-2) signs (see Figure 2D-10) may be used to direct road users to park - ride facilities.

Standard:

- 02 **The signs shall contain the word message PARK - RIDE and direction information (arrow or word message).**

Option:

- 03 PARK - RIDE signs may contain the local transit pictograph and/or carpool symbol on the sign.

Standard:

- 04 **If used, the local transit pictograph and/or carpool symbol shall be located in the top part of the sign above the message PARK - RIDE. In no case shall the vertical dimension of the local transit pictograph and/or carpool symbol exceed 18 inches.**

Guidance:

- 05 *If the function of the parking facility is to provide parking for persons using public transportation, the local transit pictograph should be used on the guide sign. If the function of the parking facility is to serve carpool riders, the carpool symbol should be used on the guide sign. If the parking facility serves both functions, both the pictograph and carpool symbol should be used.*

Standard:

- 06 **These signs shall have a retroreflective white legend and border on a rectangular green background. The carpool symbol shall be as shown for the D4-2 sign. The color of the local transit pictograph shall be selected by the local transit authority.**

Option:

- 07 To increase the target value and contrast of the local transit pictograph, and to allow the local transit pictograph to retain its distinctive color and shape, the pictograph may be included within a white border or placed on a white background.

Section 2D.49 Weigh Station Signing (D8 Series)

Support:

- 01 The general concept for Weigh Station signing is similar to Rest Area signing (see Section 2I.05) because in both cases traffic using either area remains within the right-of-way.

Standard:

- 02 **The standard installation for Weigh Station signing shall include three basic signs:**
A. Advance sign (D8-1);
B. Exit Direction sign (D8-H2); and
C. Exit Gore sign (D8-3).

Support:

- 03 Example locations of these signs are shown in Figure 2D-17.

- 04 The Exit Direction sign D8-H2 incorporates a changeable message OPEN or CLOSED within the face of the sign.

Guidance:

- 05 *The R13-H1 and R13-H2 regulatory signs (see Section 2B.60) should be used in advance of the Weigh Station Exit Direction sign following the Advance sign (see Figure 2D-17).*

Section 2D.50 Community Wayfinding Signs

Support:

- 01 Community wayfinding guide signs are part of a coordinated and continuous system of signs that direct tourists and other road users to key civic, cultural, visitor, and recreational attractions and other destinations within a city or a local urbanized or downtown area.

- 02 Community wayfinding guide signs are a type of destination guide sign for conventional roads with a common color and/or identification enhancement marker for destinations within an overall wayfinding guide sign plan for an area.

- 03 Figures 2D-18 through 2D-20 illustrate various examples of the design and application of community wayfinding guide signs.

Figure 2D-17. Example of Weigh Station Signing

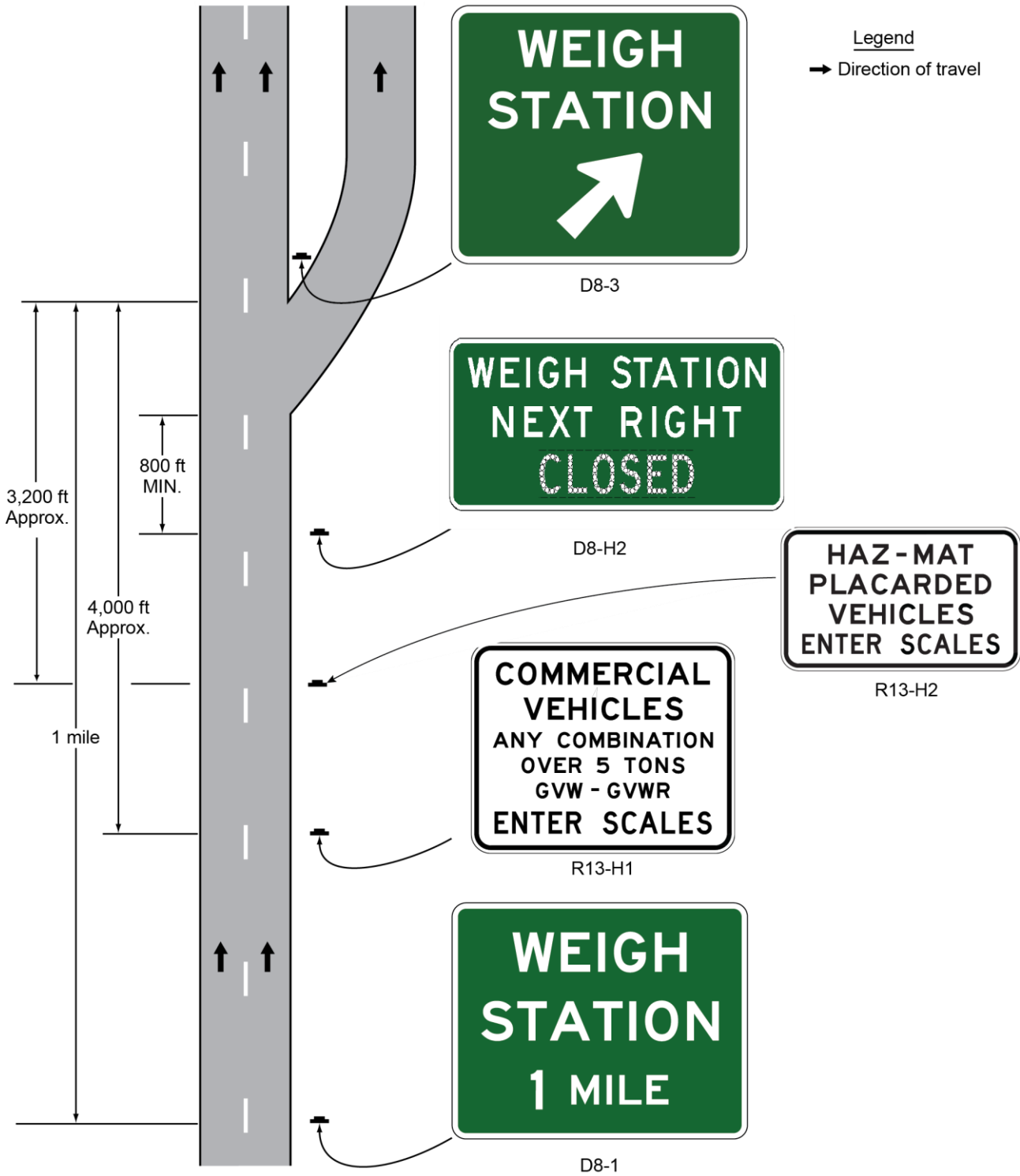

Figure 2D-18. Examples of Community Wayfinding Guide Signs

A - Community Wayfinding Guide Signs with Enhancement Markers



B - Destination Guide Signs for Color-Coded Community Wayfinding System



Standard:

- 04 The use of community wayfinding guide signs shall be limited to conventional roads. Community wayfinding guide signs shall not be installed on freeway or expressway mainlines or ramps. Direction to community wayfinding destinations from a freeway or expressway shall be limited to the use of a Supplemental Guide sign (see Section 2E.35) on the mainline and a Destination sign (see Section 2D.37) on the ramp to direct road users to the area or areas within which community wayfinding guide signs are used. The individual wayfinding destinations shall not be displayed on the Supplemental Guide and Destination signs except where the destinations are in accordance with the State or agency policy on Supplemental Guide signs.
- 05 Community wayfinding guide signs shall not be used to provide direction to primary destinations or highway routes or streets. Destination or other guide signs shall be used for this purpose as described elsewhere in this Chapter and shall have priority over any community wayfinding sign in placement, prominence, and conspicuity.
- 06 Because regulatory, warning, and other guide signs have a higher priority, community wayfinding guide signs shall not be installed where adequate spacing cannot be provided between the community wayfinding guide sign and other higher priority signs. Community wayfinding guide signs shall not be installed in a position where they would obscure the road users' view of other traffic control devices.
- 07 Community wayfinding guide signs shall not be mounted overhead.

Guidance:

- 08 If used, a community wayfinding guide sign system should be established on a local municipal or equivalent jurisdictional level or for an urbanized area of adjoining municipalities or equivalent that form an identifiable geographic entity that is conducive to a cohesive and continuous system of signs. Community wayfinding guide signs should not be used on a regional or statewide basis where infrequent or sparse placement does not contribute to a continuous or coordinated system of signing that is readily identifiable as such to the road user. In such cases, Destination or other guide signs detailed in this Chapter should be used to direct road users to an identifiable area in which the type of eligible destination described in Paragraph 1 is located.

Figure 2D-19. Example of a Community Wayfinding Guide Sign System Showing Direction from a Freeway or Expressway

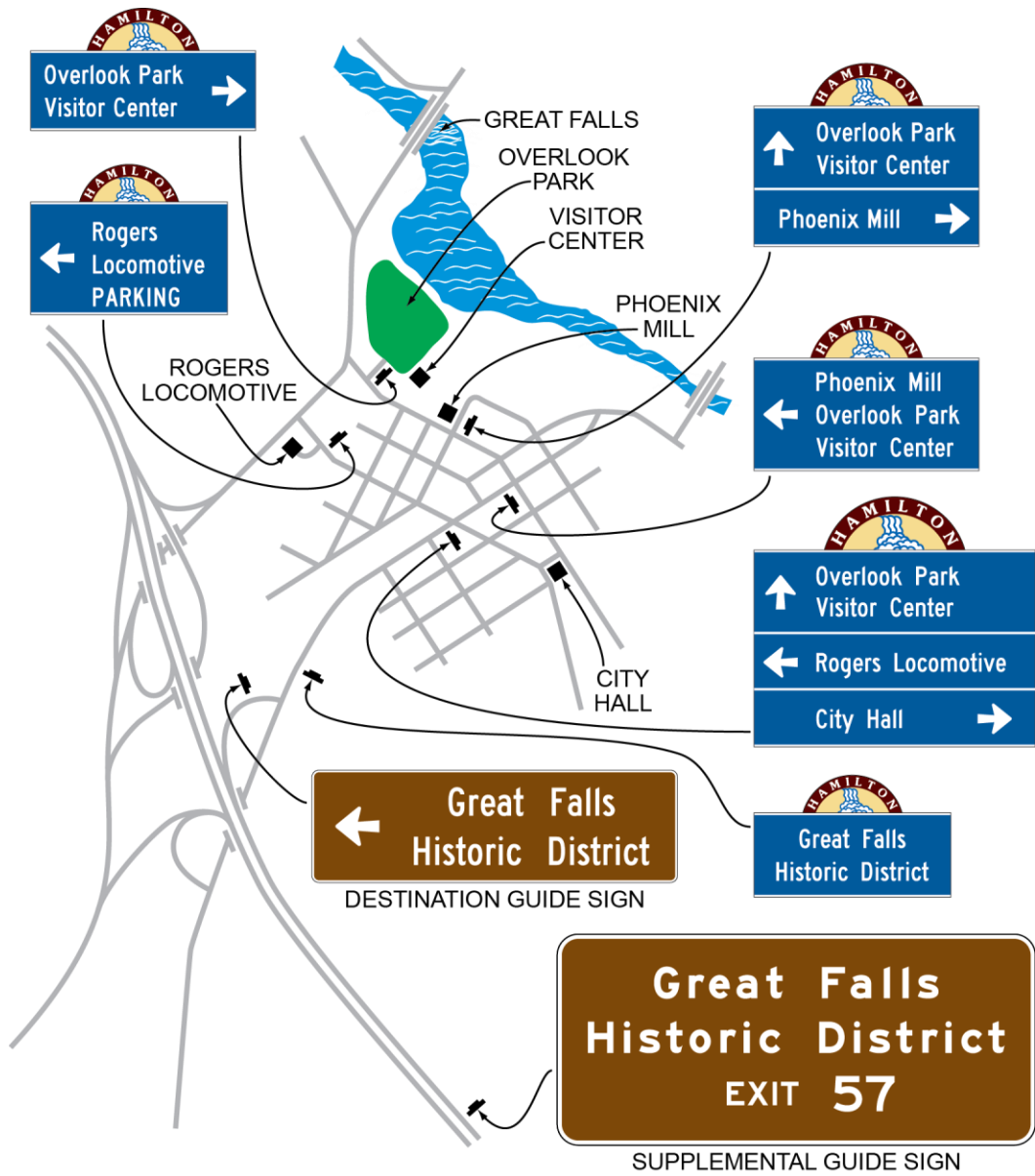

Support:

09 The specific provisions of this Section regarding the design of community wayfinding sign legends apply to vehicular community wayfinding signs and do not apply to those signs that are intended only to provide information or direction to pedestrians or other users of a sidewalk or roadside area.

Guidance:

10 *Because pedestrian wayfinding signs typically use smaller legends that are inadequately sized for viewing by vehicular traffic and because they can provide direction to pedestrians that might conflict with that appropriate for vehicular traffic, wayfinding signs designed for and intended to provide direction to pedestrians or other users of a sidewalk or other roadside area should be located to minimize their conspicuity to vehicular traffic. Such signs should be located as far as practical from the street, such as at the far edge of the sidewalk. Where locating such signs farther from the roadway is not practical, the pedestrian wayfinding signs should have their conspicuity to vehicular traffic minimized by employing one or a combination of the following methods:*

Figure 2D-20. Example of a Color-Coded Community Wayfinding Guide Sign System

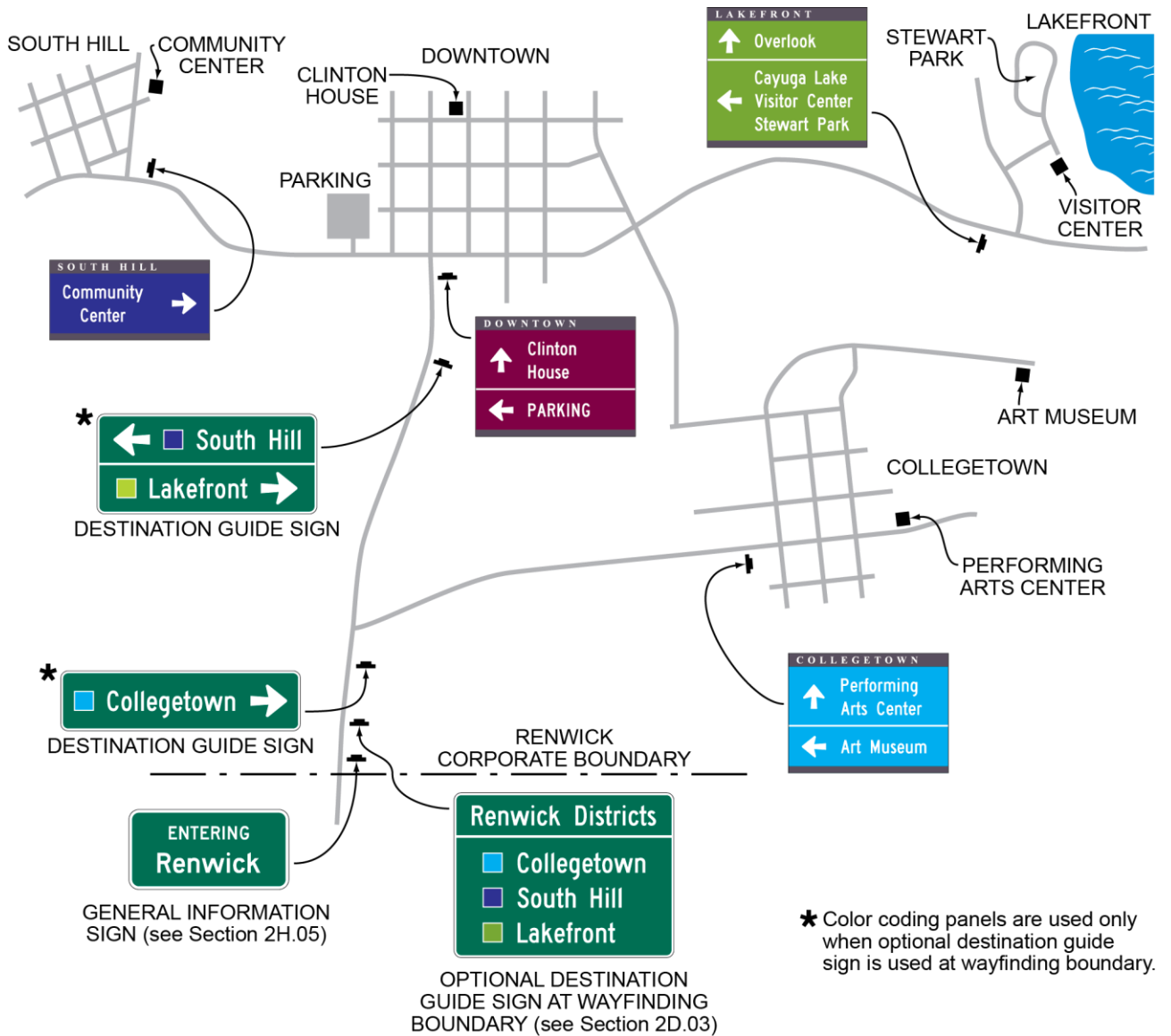

- A. Locating signs away from intersections where high-priority traffic control devices are present.
- B. Facing the pedestrian message toward the sidewalk and away from the street.
- C. Cantilevering the sign over the sidewalk if the pedestrian wayfinding sign is mounted at a height consistent with vehicular traffic signs, removing the pedestrian wayfinding signs from the line of sight in a sequence of vehicular signs.

11 To further minimize their conspicuity to vehicular traffic during nighttime conditions, pedestrian wayfinding signs should not be retroreflective.

Support:

12 Color coding is sometimes used on community wayfinding guide signs to help road users distinguish between multiple potentially confusing traffic generator destinations located in different neighborhoods or subareas within a community or area.

Option:

13 At the boundaries of the geographical area within which community wayfinding guide signing is used, an informational guide sign (see Figures 2D-18 and 2D-20) may be posted to inform road users about the

presence of wayfinding signing and to identify the meanings of the various color codes or pictographs that are being used.

Standard:

14 **These informational guide signs shall have a white legend and border on a green background and shall have a design similar to that illustrated in Figures 2D-1 and 2D-18 and shall be consistent with the basic design principles for guide signs. These informational guide signs shall not be installed on freeway or expressway mainlines or ramps.**

15 **The color coding or a pictograph of the identification enhancement markers of the community wayfinding guide signing system shall be included on the informational guide sign posted at the boundary of the community wayfinding guide signing area. The color coding or pictographs shall apply to a specific, identifiable neighborhood or geographical subarea within the overall area covered by the community wayfinding guide signing. Color coding or pictographs shall not be used to distinguish between different types of destinations that are within the same designated neighborhood or subarea. The color coding shall be accomplished by the use of different colored square or rectangular panels on the face of the informational guide sign, each positioned to the left of the neighborhood or named geographic area to which the color-coding panel applies. The height of the colored square or rectangular panels shall not exceed two times the height of the upper-case letters of the principal legend on the sign.**

Option:

16 The different colored square or rectangular panels may include either a black or a white (whichever provides the better contrast with the color of the panel) letter, numeral, or other appropriate designation to identify the destination.

17 Except for the informational guide sign posted at the boundary of the wayfinding guide sign area, community wayfinding guide signs may use background colors other than green in order to provide a color identification for the wayfinding destinations by geographical area within the overall wayfinding guide signing system. Color-coded community wayfinding guide signs may be used with or without the boundary informational guide sign displaying corresponding color-coding panels described in Paragraphs 13 through 16. Except as provided in Paragraphs 18 and 19, in addition to the colors that are approved in this Manual for use on official traffic control signs (see Section 2A.10), other background colors may also be used for the color coding of community wayfinding guide signs.

Standard:

18 **The standard colors of red, orange, yellow, purple, or the fluorescent versions thereof, fluorescent yellow-green, and fluorescent pink shall not be used as background colors for community wayfinding guide signs, in order to minimize possible confusion with critical, higher-priority regulatory and warning sign color meanings readily understood by road users.**

19 **The minimum contrast value of legend color to background color for community wayfinding guide signs shall be at least 0.70 (or 70%).**

20 **All messages, borders, legends, and backgrounds of community wayfinding guide signs and any identification enhancement markers shall be retroreflective (see Sections 2A.07 and 2A.08).**

Guidance:

21 *Community wayfinding guide signs, exclusive of any identification enhancement marker used, should be rectangular in shape. Simplicity and uniformity in design, position, and application as described in Section 2A.06 are important and should be incorporated into the community wayfinding guide sign design and location plans for the area.*

22 *Community wayfinding guide signs should be limited to three destinations per sign (see Section 2D.07).*

23 *Abbreviations (see Section 1A.15) should be kept to a minimum, and should include only those that are commonly recognized and understood.*

24 *Horizontal lines of a color that contrasts with the sign background color should be used to separate groups of destinations by direction from each other.*

- 25 The basic requirement for all highway signs, including community wayfinding signs, is that they be legible to those for whom they are intended and that they be understandable in time to permit a proper response. Section 2A.06 contains additional information on the design of signs, including desirable attributes of effective designs.

Guidance:

- 26 *Word messages should be as brief as practical and the lettering should be large enough to provide the necessary legibility distance.*

Standard:

- 27 **The minimum specific ratio of letter height to legibility distance shall comply with the provisions of Section 2A.13. The size of lettering used for destination and directional legends on community wayfinding signs shall comply with the provisions of minimum letter heights as provided in Section 2D.06.**

- 28 **Interline and edge spacing shall comply with the provisions of Section 2D.06.**

- 29 **Except as provided in Paragraph 31, the lettering style used for destination and directional legends on community wayfinding guide signs shall comply with the provisions of Section 2D.05.**

- 30 **The lettering for destinations on community wayfinding guide signs shall be a combination of lower-case letters with initial upper-case letters (see Section 2D.05). All other word messages on community wayfinding guide signs shall be in all upper-case letters.**

Option:

- 31 A lettering style other than the Standard Alphabets provided in the “Sign Designs and Markings Manual” (SDMM) may be used on community wayfinding guide signs if an engineering study determines that the legibility and recognition values for the chosen lettering style meet or exceed the values for the Standard Alphabets for the same legend height and stroke width.

Standard:

- 32 **Except for signs that are intended to be viewed only by pedestrians, bicyclists stopped out of the flow of traffic, or occupants of parked vehicles, Internet and e-mail addresses, including domain names and uniform resource locators (URL), shall not be displayed on any community wayfinding guide sign or sign assembly.**

- 33 **The arrow location and priority order of destinations shall follow the provisions described in Sections 2D.08 and 2D.37. Arrows shall be of the designs provided in Section 2D.08.**

Option:

- 34 Pictographs (see definition in Section 1A.13) may be used on community wayfinding guide signs.

Standard:

- 35 **If a pictograph is used, its height shall not exceed two times the height of the upper-case letters of the principal legend on the sign.**

- 36 **Except for pictographs, symbols that are not approved in this Manual for use on guide signs shall not be used on community wayfinding guide signs.**

- 37 **Business logos, commercial graphics, or other forms of advertising (see Section 1A.01) shall not be used on community wayfinding guide signs or sign assemblies.**

Option:

- 38 Other graphics that specifically identify the wayfinding system, including identification enhancement markers, may be used on the overall sign assembly and sign supports.

Support:

- 39 An enhancement marker consists of a shape, color, and/or pictograph that is used as a visual identifier for the community wayfinding guide signing system for an area. Figure 2D-18 shows examples of identification enhancement marker designs that can be used with community wayfinding guide signs.

Option:

40 An identification enhancement marker may be used in a community wayfinding guide sign assembly, or may be incorporated into the overall design of a community wayfinding guide sign, as a means of visually identifying the sign as part of an overall system of community wayfinding signs and destinations.

Standard:

41 **The sizes and shapes of identification enhancement markers shall be smaller than the community wayfinding guide signs themselves. Identification enhancement markers shall not be designed to have an appearance that could be mistaken by road users as being a traffic control device.**

Guidance:

42 *The area of the identification enhancement marker should not exceed 1/5 of the area of the community wayfinding guide sign with which it is mounted in the same sign assembly.*

Section 2D.51 Truck, Passing, or Climbing Lane Signs (D17-1, D17-2)*Guidance:*

01 *If an extra lane has been provided for trucks and other slow-moving traffic, a NEXT TRUCK LANE XX MILES (D17-1) sign and/or a TRUCK LANE XX MILES (D17-2) sign (see Figure 2D-21) should be installed in advance of the lane.*

Option:

02 Alternative legends such as PASSING LANE or CLIMBING LANE may be used instead of TRUCK LANE.

03 Section 2B.31 contains information regarding regulatory signs for these types of lanes.

Section 2D.52 Slow Vehicle Turn-Out Sign (D17-7)*Guidance:*

01 *If a slow vehicle turn-out area has been provided for slow-moving traffic, a SLOW VEHICLE TURN-OUT XX MILES (D17-7) sign (see Figure 2D-21) should be installed in advance of the turn-out area.*

Option:

02 Section 2B.35 contains information regarding regulatory signs for slow vehicle turn-out areas.

Section 2D.53 Signing of Named Highways

Option:

01 Guide signs may contain street or highway names if the purpose is to enhance driver communication and guidance; however, they are to be considered as supplemental information to route numbers.

Standard:

02 **Highway names shall not replace official numeral designations.**

03 **Memorial names (see Section 2M.10) shall not appear on supplemental signs or on any other information sign on or along the highway or its intersecting routes.**

04 **The use of route signs shall be restricted to signs officially used for guidance of traffic in accordance with this Manual and the “Purpose and Policy” statement of the American Association of State Highway and Transportation Officials that applies to Interstate and U.S. numbered routes (see the Preface for AASHTO’s address).**

Option:

05 Unnumbered routes having major importance to proper guidance of traffic may be signed if carried out in accordance with the aforementioned policies. For unnumbered highways, a name to enhance route guidance may be used where the name is applied consistently throughout its length.

Guidance:

06 *Only one name should be used to identify any highway, whether numbered or unnumbered.*

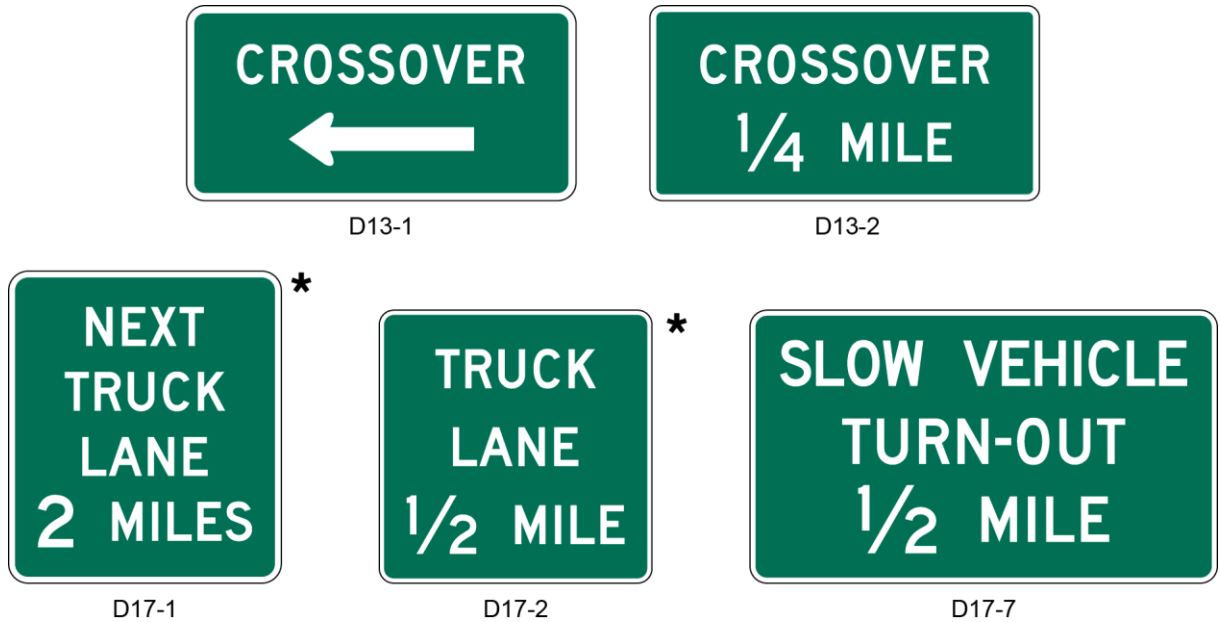
Figure 2D-21. Crossover, Truck Lane, and Slow Vehicle Signs

* The words PASSING or CLIMBING may be substituted for the word TRUCK on the D17-1 and D17-2 signs.

Section 2D.54 Crossover Signs (D13-1, D13-2)

Option:

- 01 Crossover signs may be installed on divided highways to identify median openings not otherwise identified by warning or other guide signs.

Standard:

- 02 **A CROSSOVER (D13-1) sign (see Figure 2D-21) shall not be used to identify a median opening that is permitted to be used only by official or authorized vehicles. If used, the sign shall be a horizontal rectangle of appropriate size to carry the word CROSSOVER and a horizontal directional arrow. The CROSSOVER sign shall have a white legend and border on a green background.**

Guidance:

- 03 *If used, the CROSSOVER sign should be installed immediately beyond the median opening, either on the right-hand side of the roadway or in the median.*

Option:

- 04 The Advance Crossover (D13-2) sign (see Figure 2D-21) may be installed in advance of the CROSSOVER sign to provide advance notice of the crossover.

Standard:

- 05 **If used, the Advance Crossover sign shall be a horizontal rectangle of appropriate size to carry the word CROSSOVER and the distance to the median opening. The sign shall have white legend and border on a green background.**

Guidance:

- 06 *The distance displayed on the Advance Crossover sign should be 1 MILE, 1/2 MILE, or 1/4 MILE), unless unusual conditions require some other distance. If used, the sign should be installed either on the right-hand side of the roadway or in the median at approximately the distance displayed on the sign.*

Section 2D.55 National Scenic Byways Signs (D6-4, D6-4a)**Support:**

- 01 Certain roads have been designated by the U.S. Secretary of Transportation as National Scenic Byways or All-American Roads based on their archeological, cultural, historic, natural, recreational, or scenic qualities.

Option:

- 02 Highway agencies may install the National Scenic Byways (D6-4 or D6-4a) signs at entrance points to a route that has been recognized by the U.S. Secretary of Transportation as a National Scenic Byway or an All-American Road. The D6-4 or D6-4a sign may be installed on route sign assemblies (see Figure 2D-22) or as part of larger roadside structures. National Scenic Byways signs may also be installed at periodic intervals along the designated route and at intersections where the designated route turns or follows a different numbered highway. At locations where roadside features have been developed to enhance the traveler's experience such as rest areas, historic sites, interpretive facilities, or scenic overlooks, the National Scenic Byways sign may be placed on the associated sign assembly to inform travelers that the site contributes to the byway travel experience.

Standard:

- 03 **When a National Scenic Byways sign is installed on a National Scenic Byway or an All-American Road, the design shown for the D6-4 or D6-4a sign in Figure 2D-22 shall be used. Use of this design shall be limited to routes that have been designated as a National Scenic Byway or All-American Road by the U.S. Secretary of Transportation.**
- 04 **If used, the D6-4 or D6-4a sign shall be placed such that the roadway route signs have primary visibility for the road user.**

Figure 2D-22. Examples of Use of the National Scenic Byways Sign

Section 2D.56 Ohio Byway Signs (M8-H3, M8-H3P)

Support:

- 01 Certain roads have been designated by the Ohio Department of Transportation (ODOT) as Ohio Byways based on their archeological, cultural, historic, natural, recreational, or scenic qualities.

Standard:

- 02 **A route designated by ODOT as an Ohio Byway shall be signed.**

Guidance:

- 03 *The Ohio Byway (M8-H3) sign should be used to mark these designated routes (see Figure 2D-23).*
- 04 *The sign should be installed in a manner similar to other route signs. Ohio Byway signs should be installed in both directions along an established route. A sign should be installed at the beginning of the route, in advance of and at turns in the route, and an Ohio Byways sign with an END (M4-6) auxiliary sign should be installed at the end of the route. Additional signs should be installed at 5 to 10-mile intervals and at other key locations along the route.*
- 05 *Auxiliary signs used with Ohio Byway signs should have a white legend on a green background.*

Option:

- 06 An Ohio Byway sign may be installed after a turn to confirm the routing, and on major intersecting highways advising of the junction with the designated route.
- 07 The Ohio Byway sign may be installed in an assembly with other route signs.
- 08 The Ohio Byway (M8-H3P) supplemental plaque may be used to identify the name of the byway. An example is displayed in Figure 2D-23.

Guidance:

- 09 *If used, the M8-H3P supplemental plaque should be mounted below the Ohio Byway sign.*

Figure 2D-23. Ohio Byway Signs

M8-H3



M8-H3P

Intentionally blank

CHAPTER 2E. GUIDE SIGNS—FREEWAYS AND EXPRESSWAYS

Section 2E.01 Scope of Freeway and Expressway Guide Sign Standards

Support:

- 01 The provisions of this Chapter provide a uniform and effective system of signing for high-volume, high-speed motor vehicle traffic on freeways and expressways. The requirements and specifications for expressway signing exceed those for conventional roads (see Chapter 2D), but are less than those for freeway signing. Since there are many geometric design variables to be found in existing roads, a signing concept commensurate with prevailing conditions is the primary consideration. Section 1A.13 includes definitions of freeway and expressway.
- 02 Guide signs for freeways and expressways are primarily identified by the name/type of the sign rather than by an assigned sign designation. Ohio's Freeway and Expressway Guide Sign Design Method is detailed in Appendix C of the "Sign Designs and Markings Manual" (SDMM) (see Section 1A.11). It is based on a Sign Level system. Types of signs are assigned different levels (i.e., 0, 1, 2, 3 and 4). For example, an overhead Pull-Thru Sign is a level 1 sign and a mainline Supplemental Guide Sign is level 2. The level assignment is used to determine the size of elements used in the design of the sign (see Tables 2E-2 and 2E-3). The design method described in Appendix C of the SDMM also applies to entrance ramp approach signs on roads intersecting freeways and expressways.

Standard:

- 03 **The provisions of this Chapter shall apply to any highway that meets the definition of freeway or expressway facilities.**

Section 2E.02 Freeway and Expressway Signing Principles

Support:

- 01 The development of a signing system for freeways and expressways is approached on the premise that the signing is primarily for the benefit and direction of road users who are not familiar with the route or area. The signing furnishes road users with clear instructions for orderly progress to their destinations. Sign installations are an integral part of the facility and, as such, are best planned concurrently with the development of highway location and geometric design. For optimal results, plans for signing are analyzed during the earliest stages of preliminary design, and details are correlated as final design is developed. The excessive signing found on many major highways usually is the result of using a multitude of signs that are too small and that are poorly designed and placed to accomplish the intended purpose.
- 02 Freeway and expressway signing is to be considered and developed as a planned system of installations. An engineering study is sometimes necessary for proper solution of the problems of many individual locations, but, in addition, consideration of an entire route is necessary.

Guidance:

- 03 *Road users should be guided with consistent signing on the approaches to interchanges, when they drive from one State to another, and when driving through rural or urban areas. Because geographical, geometric, and operating factors regularly create significant differences between urban and rural conditions, the signing should take these conditions into account.*
- 04 *Guide signs on freeways and expressways should serve distinct functions as follows:*
- A. Give directions to destinations, or to streets or highway routes, at intersections or interchanges;*
 - B. Furnish advance notice of the approach to intersections or interchanges;*
 - C. Direct road users into appropriate lanes in advance of diverging or merging movements;*
 - D. Identify routes and directions on those routes;*
 - E. Show distances to destinations;*
 - F. Indicate access to general motorist services, rest, scenic, and recreational areas; and*
 - G. Provide other information of value to the road user.*

Section 2E.03 Guide Sign Classification

Support:

- 01 Freeway and expressway guide signs are classified and treated in the following categories:
- A. Route signs and Trailblazer Assemblies (see Section 2E.27),

- B. At-Grade Intersection signs (see Section 2E.29),
- C. Interchange signs (see Sections 2E.30 through 2E.39),
- D. Interchange Sequence signs (see Section 2E.40),
- E. Community Interchanges Identification signs (see Section 2E.41),
- F. NEXT XX EXITS signs (see Section 2E.42),
- G. Weigh Station signing (see Section 2E.54),
- H. Miscellaneous Information signs (see Section 2H.04),
- I. Reference Location signs (see Section 2H.05),
- J. General Service signs (see Chapter 2I),
- K. Rest Area and Other Roadside Area signs (see Section 2I.05),
- L. Tourist Information and Welcome Center signs (see Section 2I.08),
- M. Radio Information signing (see Section 2I.09),
- N. Carpool and Ridesharing signing (see Section 2I.11),
- O. Specific Service signs (see Chapter 2J), and
- P. Recreational and Cultural Interest Area signs (see Chapter 2M).

Section 2E.04 General

Support:

- 01 Signs are designed so that they are legible to road users approaching them and readable in time to permit proper responses. Desired design characteristics include: (a) long visibility distances, (b) large lettering symbols, and arrows, and (c) short legends for quick comprehension.

Standard:

- 02 **Standard shapes and colors shall be used so that traffic signs can be promptly recognized by road users.**

Section 2E.05 Color of Guide Signs

Standard:

- 01 **Guide signs on freeways and expressways, except as otherwise provided in this Manual, shall have white letters, symbols, arrows, and borders on a green background.**

Support:

- 02 Color requirements for route signs and trailblazers, signs with blank-out or changeable messages, signs for services, rest areas, park and recreational areas, and for certain miscellaneous signs are provided in the individual Sections dealing with the particular sign or sign group.

Section 2E.06 Retroreflection or Illumination

Standard:

- 01 **Letters, numerals, symbols, arrows, and borders of all guide signs shall be retroreflectorized. The background of all guide signs that are not independently illuminated shall be retroreflective.**

Support:

- 02 Where there is no serious interference from extraneous light sources, retroreflectorized post-mounted signs usually provide adequate nighttime visibility.

- 03 On freeways and expressways where much driving at night is done with low-beam headlights, the amount of headlight illumination incident to an overhead sign display is relatively small.

Guidance:

- 04 *Overhead sign installations should be illuminated unless an engineering study shows that retroreflectorization alone will perform effectively. The type of illumination chosen should provide effective and reasonably uniform illumination of the sign face and message.*

Section 2E.07 Characteristics of Urban Signing

Support:

- 01 Urban conditions are characterized not so much by city limits or other arbitrary boundaries, as by the following features:

- A. Mainline roadways with more than two lanes in each direction;
 - B. High traffic volumes on the through roadways;
 - C. High volumes of traffic entering and leaving interchanges;
 - D. Interchanges closely spaced;
 - E. Roadway and interchange lighting;
 - F. Three or more interchanges serving the major city;
 - G. A loop, circumferential, or spur serving a sizable portion of the urban population; and
 - H. Visual clutter from roadside development.
- 02 Operating conditions and road geometrics on urban freeways and expressways usually make special sign treatments desirable, including:
- A. Use of Interchange Sequence signs (see Section 2E.40);
 - B. Use of sign spreading to the maximum extent possible (see Section 2E.11);
 - C. Elimination of General or Specific Service signing (see Chapters 2I and 2J);
 - D. Reduction to a minimum of post-interchange signs (see Section 2E.38);
 - E. Display of advance signs at distances closer to the interchange, with appropriate adjustments in the legend (see Section 2E.33);
 - F. Use of overhead signs on roadway structures and independent sign supports (see Section 2E.25);
 - G. Use of Overhead Arrow-per-Lane or Diagrammatic guide signs in advance of intersections and interchanges (see Section 2E.21 and 2E.22); and
 - H. Frequent use of street names as the principal message in guide signs.
- 03 Lower speeds which are often characteristic of urban operations do not justify lower signing standards. Typical urban traffic patterns are more complex for the road user to negotiate; therefore, large, easy-to-read legends are just as necessary as on rural highways.

Section 2E.08 Characteristics of Rural Signing

Support:

- 01 Rural areas ordinarily have greater distances between interchanges, which permits adequate spacing for the sequences of signs on the approach to and departure from each interchange. However, the absence of traffic in adjoining lanes and on entering or exiting ramps often adds monotony or inattention to rural driving. This increases the importance of signs that call for decisions or actions.

Guidance:

- 02 *Where there are long distances between interchanges and the alignment is relatively unchanging, signs should be positioned for their best effect on road users. The tendency to group all signing in the immediate vicinity of rural interchanges should be avoided by considering the entire route in the development of signing plans. Extra effort should be given to the placement of signs at natural target locations to command the attention of the road user, particularly when the message requires an action by the road user.*

Section 2E.09 Signing of Named Highways

Support:

- 01 Section 2D.53 contains information, which is also applicable to freeways and expressways, regarding the use of highway names on the signing for unnumbered highways to enhance route guidance and facilitate travel.
- 02 Section 2M.10 contains information regarding memorial signing of routes, bridges, or highway components.

Section 2E.10 Amount of Legend on Guide Signs

Guidance:

- 01 *No more than two destination names or street names should be displayed on any Advance Guide sign (Section 2E.33) or Exit Direction sign (Section 2E.36). A city name and street name on the same sign should be avoided. Where two or three signs are placed on the same supports, destinations or names should be limited to one per sign, or to a total of three in the display. Sign legends should not exceed three lines of copy, exclusive of the exit number and action or distance information.*

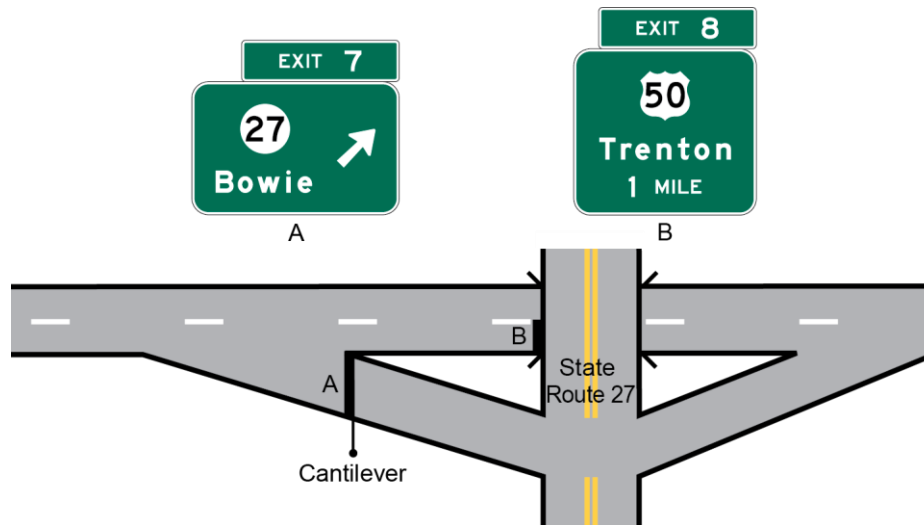
Figure 2E-1. Example of Guide Sign Spreading

02 The legend sequence from top to bottom should be route shield information, street name(s), and the destination name(s). This sequence should remain the same even when one or more of these components is not included.

03 When appropriate, cardinal direction information should be included either above or beside the shield(s). Regardless of the number of route shields used, and the presence or absence of cardinal direction information, the route shield component of the sign is considered as one line.

Option:

04 Additional destination names may be included on a Supplemental Guide sign.

Section 2E.11 Number of Signs at an Overhead Installation and Sign Spreading

Guidance:

01 If overhead signs are warranted, as set forth in Section 2A.17, the number of signs at these locations should be limited to only those essential in communicating pertinent destination information to the road user. Exit Direction signs for a single exit and the Advance Guide signs should have only one sign with one or two destinations. Regulatory signs, such as speed limits, should not be used in conjunction with overhead guide sign installations. Because road users have limited time to read and comprehend sign messages, there should not be more than three guide signs displayed at any one location either on the overhead structure or its support.

Option:

02 At overhead locations, more than one sign may be installed to advise road users of a multiple exit condition at an interchange. If the roadway ramp or crossing roadway has complex or unusual geometrics, additional signs with confirming messages may be provided to properly guide the road user.

Support:

03 Sign spreading is a concept where major overhead signs are spaced so that road users are not overloaded with a group of signs at a single location. Figure 2E-1 illustrates an example of sign spreading.

Guidance:

04 Where overhead signing is used, sign spreading should be used at all single exit interchanges and to the extent possible at multi-exit interchanges. Sign spreading should be accomplished by use of the following:

- A. The Exit Direction sign should be the only sign used in the vicinity of the gore (other than the Exit Gore sign). It should be located overhead near the theoretical gore and generally on an overhead sign support structure.
- B. The Advance Guide sign to indicate the next interchange exit should be placed near the crossroad location. If the crossroad goes over the mainline, the Advance Guide sign should be placed on the overcrossing structure or on a separate structure immediately in front of the overcrossing structure.

Section 2E.12 Pull-Through Signs

Support:

- 01 Pull-Through signs (see Figure 2E-2) are overhead guide signs intended for through traffic.

Guidance:

- 02 *Pull-Through signs should be used where the geometrics of a given interchange are such that it is not clear to the road user as to which is the through roadway, or where additional route guidance is desired. Pull-Through signs with down arrows should be used where the alignment of the through lanes is curved and the exit direction is straight ahead, where the number of through lanes is not readily evident, and at multi-lane exits where there is a reduction in the number of through lanes.*

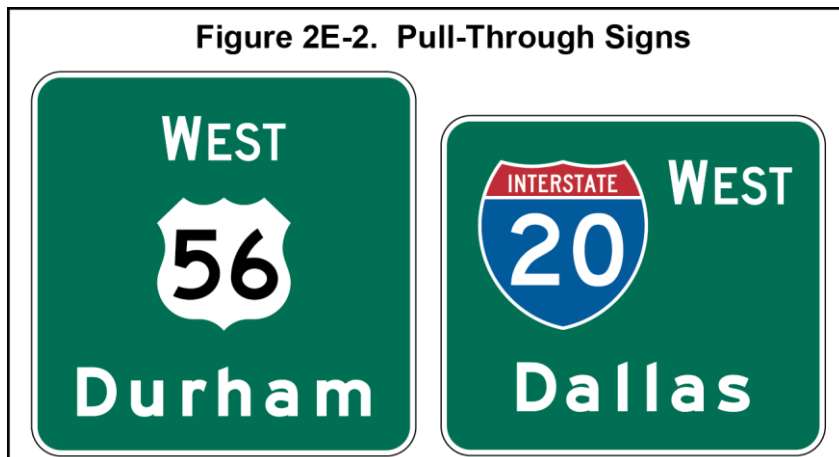

Support:

- 03 Section 2E.20 through 2E.24 contain information regarding the use of Overhead Arrow-per-Lane or Diagrammatic guide signs at multi-lane exits where there is a reduction in the number of through lanes and a through lane becomes an interior option lane for through or exiting traffic.

Section 2E.13 Designation of Destinations

Standard:

- 01 **The direction of a freeway and the major destinations or control cities along it shall be clearly identified through the use of appropriate destination legends (see Section 2D.37). Successive freeway guide signs shall provide continuity in destination names and consistency with available map information. At any decision point, a given destination shall be indicated by way of only one route.**

Guidance:

- 02 *Control city legends should be used in the following situations along a freeway:*
- A. *At interchanges between freeways;*
 - B. *At separation points of overlapping freeway routes;*
 - C. *On directional signs on intersecting routes, to guide traffic entering the freeway;*
 - D. *On Pull-Through signs; and*
 - E. *On the bottom line of post-interchange distance signs.*

Support:

- 03 Continuity of destination names is also useful on expressways serving long-distance or intrastate travel.
- 04 The determination of major destinations or control cities is important to the quality of service provided by the freeway. Control cities on freeway guide signs are selected by the States and are contained in the “Guidelines for the Selection of Supplemental Guide Signs for Traffic Generators Adjacent to Freeways, 4th Edition/Guide Signs, Part II: Guidelines for Airport Guide Signing/Guide Signs, Part III: List of Control Cities for Use in Guide Signs on Interstate Highways,” published by and available from the American Association of State and Highway Transportation Officials (see Section 1A.11). Additional information, including a list of the control cities identified for Ohio’s Interstate Highway System is provided in Part 2 of ODOT’s “Traffic Engineering Manual” (see Section 1A.11).

Section 2E.14 Size and Style of Letters and Signs

Standard:

- 01 **Except as provided in Section 2A.11, the sizes of freeway and expressways guide signs that have standardized designs shall be as shown in Table 2E-1.**

02 Section 2A.11 contains information regarding the applicability of the various columns in Table 2E-1.

Option:

03 Signs larger than those shown in Table 2E-1 may be used (see Section 2A.11).

Standard:

04 **For all freeway and expressway signs that do not have a standardized design, the message dimensions shall be determined first, and the outside sign dimensions secondarily. Word messages in the legend of expressway guide signs shall be in letters at least 8 inches high. Larger lettering shall be used for major guide signs at or in advance of interchanges and for all overhead signs. Minimum numeral and letter sizes for freeway and expressway guide signs according to interchange classification, type of sign, and component of sign legend shall be as shown in Tables 2E-2 and 2E-3. All names of places, streets, and highways on freeway and expressway guide signs shall be composed of lower-case letters with initial upper-case letters. The letters and the numerals used shall be Series E(M) as shown in the SDMM (see Section 1A.11). The nominal loop height of the lower-case letters shall be 3/4 of the height of the initial upper-case letter (see Paragraph 2 of Section 2D.05 for additional information on the specification of letter heights). Other word legends shall be composed of upper-case letters. Interline and edge spacing shall be as provided in Section 2E.15.**

05 **Lettering size on freeway and expressway signs shall be the same for both rural and urban conditions.**

Support:

06 Sign size is determined primarily in terms of the length of the message and the size of the lettering necessary for proper legibility. Letter style and height, and arrow design have been standardized for freeway and expressway signs to assure uniform and effective application.

07 Designs for upper-case and lower-case alphabets together with tables of recommended letter spacing, are shown in the SDMM (see Section 1A.11).

Guidance:

08 *Other sign letter size requirements not specifically identified elsewhere in this Manual should be guided by these specifications. Abbreviations should be kept to a minimum (see Section 2E.17).*

Support:

09 A sign mounted over a particular roadway lane to which it applies might have to be limited in horizontal dimension to the width of the lane, so that another sign can be placed over an adjacent lane. The necessity to maintain proper vertical clearance might also place a further limitation on the size of the overhead sign and the legend that can be accommodated.

Section 2E.15 Interline and Edge Spacing

Guidance:

01 *Interline spacing of words should be approximately three-fourths the upper-case letter height of the larger of the adjacent lines.*

02 *The spacing to the top and bottom borders should be approximately three-fourths the upper-case letter height of the adjacent lines. The lateral spacing to the vertical borders should be essentially the same as the height of the largest letter.*

Support:

03 SDMM Appendix C contains additional information on interline and edge spacing.

Section 2E.16 Sign Borders

Standard:

01 **Signs shall have a border of the same color as the legend in order to outline their distinctive shape and thereby give them easy recognition and a finished appearance.**

Table 2E-1. Freeway or Expressway Guide Sign and Plaque Sizes¹ (Sheet 1 of 2)

Sign or Plaque	Sign Designation	Section	Minimum Size
Exit Number (plaque)	E1-H5P	2E.31	Varies x 30
LEFT (plaque)	E1-5aP	2E.33	72 x 30
Left Exit Number (plaque)	E1-H5bP	2E.31	Varies x 54
NEXT EXIT XX MILES (1 line)	E2-H1P	2E.34	144 x 24
NEXT EXIT XX MILES (2 lines)	E2-H1aP	2E.34	84 x 36
Exit Gore (no exit number)	E5-H1	2E.37	72 x 60
Exit Gore (with exit number)	E5-H1a	2E.37	Varies x 60
Exit Number (plaque)	E5-H1bP	2E.37	Varies x 30
Narrow Exit Gore	E5-H1c	2E.37	48 x 84 ²
Exit Only (with arrow)	E11-1, 1d	2E.24	180 ³ x 36
EXIT	E11-1a	2E.24	54 x 18
ONLY	E11-1b	2E.24	54 x 18
EXIT ONLY	E11-1c	2E.24	108 x 18
Exit Only (with two arrows)	E11-1e, 1f	2E.24	204 ³ x 36
LEFT	E11-2	2E.40	60 x 18
Exit Gore Advisory Speed (plaque)	E13-1P	2E.37	72 x 24
Exit Direction Advisory Speed	E13-2	2E.36	162 x 24
Interstate Route Sign (1 or 2 digits)	M1-1	2E.27	36 x 36
Interstate Route Sign (3 digits)	M1-1	2E.27	45 x 36
Off-Interstate Route Sign (1 or 2 digits)	M1-2, 3	2E.27	36 x 36
Off-Interstate Route Sign (3 digits)	M1-2, 3	2E.27	45 x 36
U.S. Route Sign (1 or 2 digits)	M1-4	2E.27	36 x 36
U.S. Route Sign (3 digits)	M1-4	2E.27	45 x 36
State Route Sign (1 or 2 digits)	M1-5	2D.11	36 x 36
State Route Sign (3 digits)	M1-H5	2D.11	45 x 36
County Route Sign (1, 2, or 3 digits)	M1-6, H6a	2D.11	36 x 36
Forest Route Sign (1, 2, or 3 digits)	M1-7	2D.11	36 x 36
Eisenhower Interstate System	M1-10	2E.28	36 x 36
Junction	M2-1	2D.13	30 x 21
Combination Junction (2 Route Signs)	M2-2	2D.14	60 x 48 ²
Cardinal Direction	M3-1, 2, 3, 4	2D.15	36 x 18
ALTERNATE	M4-1, 1a	2D.17	36 x 18
BY-PASS	M4-2	2D.18	36 x 18
BUSINESS	M4-3	2D.19	36 x 18
TRUCK	M4-4	2D.20	36 x 18
TO	M4-5	2D.21	36 x 18
END	M4-6	2D.22	36 x 18
TEMPORARY	M4-7, 7a	2D.24	36 x 18
BEGIN	M4-14	2D.23	36 x 18
Advance Turn Arrow	M5-1, 2, 3	2D.26	30 x 21
Lane Designation	M5-4, 5, 6	2D.27	36 x 24
Directional Arrow	M6-1, 2, 2a, 3, 4, 5, 6, 7	2D.28	30 x 21
Distance (1 line)	E7-H1	2E.39	Varies x 36
Distance (2 lines)	E7-H1	2E.39	Varies x 60
Distance (3 lines)	E7-H1	2E.39	Varies x 84
Interchange Sequence	E7-H2	2E.40	Varies x 60
Community Interchanges Identification	E7-H3	2E.41	Varies x 84
NEXT XX EXITS	E7-H4	2E.42	Varies x 60
Street Name	D3-H3, H3a	2E.29.1	Varies x 36

Table 2E-1. Freeway or Expressway Guide Sign and Plaque Sizes¹ (Sheet 2 of 2)

Sign or Plaque	Sign Designation	Section	Minimum Size
Advance Street Name (2 lines)	D3-H4	2E.29.2	Varies x 60
Advance Street Name (3 lines)	D3-H4	2E.29.2	Varies x 84
Advance Street Name (4 lines)	D3-H4	2E.29.2	Varies x 108
Park - Ride	D4-2	2D.48	36 x 48
National Scenic Byways	D6-4	2D.55	24 x 24
National Scenic Byways	D6-4a	2D.55	24 x 12
Weigh Station XX Miles	D8-1	2E.54	96 x 72
Weigh Station Next Right (w/ OPEN/CLOSED)	D8-H2	2E.54	156 x 72
Weigh Station (with arrow)	D8-3	2E.54	84 x 72
CROSSOVER	D13-1, 2	2D.54	78 x 42
Freeway Entrance	D13-3	2D.46	48 x 30
Freeway Entrance (with arrow)	D13-3a	2D.46	48 x 42
Combination Lane Use / Destination	D15-1	2D.33	Varies x 96
NEXT TRUCK LANE XX MILES	D17-1	2D.51	60 x 66
TRUCK LANE XX MILES	D17-2	2D.51	60 x 54
SLOW VEHICLE TURN-OUT XX MILES	D17-7	2D.52	96 x 54

Notes:

- a.) Larger signs may be used when appropriate;
b.) Dimensions in inches are shown as width x height;
- The size shown is for a typical sign as illustrated in the figures in Chapters 2D and 2E. The size should be determined based on the amount of legend required for the sign.
- The width shown represents the minimum dimension. The width shall be increased as appropriate to match the width of the guide sign.

Guidance:

- 02 For major guide signs on freeways and expressways, the border should have a width of 2 inches. For smaller guide signs, a border width of 1.25 inches should be used, but the width should not exceed the stroke width of the lettering of the principal legend on the sign.
- 03 Corner radii of sign borders should be approximately 1/8 of the sign height on guide signs, except that the radii should not exceed 12 inches on any sign.

Option:

- 04 The sign material in the area outside of the corner radius may be trimmed.

Section 2E.17 Abbreviations**Guidance:**

- 01 Abbreviations should be kept to a minimum; however, they are useful when complete destination messages produce excessively long signs. If used, abbreviations should be unmistakably recognized by road users (see Section 1A.15). Longer commonly used words that are not part of a proper name and are readily recognizable, such as Street, Boulevard, and Avenue, should be abbreviated to expedite recognition of the sign legend by reducing the amount and complexity of the legend.
- 02 Periods, apostrophes, question marks, ampersands, or other punctuation or characters that are not letter, numerals, or hyphens should not be used in abbreviations, unless necessary to avoid confusion.
- 03 The solidus (slanted line or forward slash) is intended to be used for fractions only and should not be used to separate words on the same line of legend. Instead, a hyphen should be used for this purpose, such as "CARS – TRUCKS."

Standard:

- 04 The words **NORTH, SOUTH, EAST, and WEST** shall not be abbreviated when used with route signs to indicate cardinal directions on guide signs.

Table 2E-2. Signing Levels for Freeway and Expressway Guide Signs According to Interchange Classification

Type of Sign	Signing Level Based on Type of Interchange (see Section 2E.32)			
	Major		Intermediate	Minor
	Category a	Category b		
Post-mounted Mainline Freeway and Expressway Advance Guide and Exit Direction Signs	0	1	1	2
Overhead Mainline Freeway and Expressway Advance Guide and Exit Direction Signs	1	1	1	—
Mainline Freeway and Expressway Pull-Through Signs	1	1	1	—
Mainline Freeway and Expressway Supplemental Guide Signs	2	2	2	—
Post-Mounted Guide Signs on Freeway and Expressway Collector-Distributor Road	1	1	1	—
Overhead Guide Signs on Freeway and Expressway Collector-Distributor Road	2	2	2	—
Freeway and Expressway Advance Entrance Direction and Entrance Direction Signs on Multi-Lane Conventional Road	3	3	3	—
Freeway and Expressway Advance Entrance Direction and Entrance Direction Signs on Single Lane Conventional Road	4	4	4	—

Note: Use signing levels above to determine proper element sizes from Table 2E-3

Section 2E.18 Symbols

Standard:

- 01 Symbol designs shall be unmistakably like those shown in this Manual and in Appendix A of the SDMM (see Section 1A.11).

Guidance:

- 02 A special effort should be made to balance legend components for maximum legibility of the symbol with the rest of the sign.

Option:

- 03 Educational plaques may be used below symbol signs where needed.

Section 2E.19 Arrows for Interchange Guide Signs

Standard:

- 01 Arrows used on interchange guide signs shall be of the types shown in Figure 2D-2 and shall comply with the provisions of this Section and Section 2D.08.
- 02 Except on Overhead Arrow-per-Lane guide signs (see Section 2E.21) and on Exit Direction signs for lane drops (see Section 2E.24), and except as provided in Paragraphs 3 and 4, directional arrows

Table 2E-3. Minimum Element Sizes for Freeway and Expressway Guide Signs According to Signing Levels

Guide Sign Element Sizes (all dimensions in inches)					
Sign Element	Signing Level				
	0	1	2	3	4
Route Shield (height)	48	36	36	24	24
Cardinal Direction used with Route Shield	16	12	12	8	8*
First Letter of Cardinal Direction used with Route Shield	20	15	15	10	10*
Street Name (upper-case letter height)	20	16	13.3	10.67	8
Cardinal Direction used with Street Name (first letter not enlarged)	15	12	10	8	6
Destination (upper-case letter height)	20	16	13.3	10.67	8
Distance Message	12	10	10	8	6
Distance Numeral	18	15	15	12	9
Fraction Numeral (Standard Alphabet Series E)	12	10	10	8	6
Fraction Numeral (Clearview 4-W)	12.6	10.5	10.5	8.4	6.3
Action Message (KEEP RIGHT, NEXT LEFT, etc.) **	12	12	10	8	6
Action Message which includes a Route Shield (USE 71 SOUTH, FOLLOW 40 WEST, etc.)	16	12	12	8	8
EXIT ONLY	12	12	10	10	8
Type A "Up" Arrow	35 x 22.25	35 x 22.25	30 x 18.25	30 x 18.25	25 x 15.12
Type B Arrow	25 x 22.25	25 x 22.25	20 x 18.25	20 x 18.25	17 x 15.12
Type C "Advance Turn" Arrow	n/a	n/a	18 x 16	16 x 13	12 x 10
"Down" Arrow	n/a	32 x 22	24 x 16.5	24 x 16.5	16 x 11
Border	2	2	2	1.25	1.25
Arrow Descriptions:					
Type A arrow is used sloping or vertical with point up located to the side of the sign or horizontally at the bottom.					
Type B arrow is used for optional lane signing at the bottom of the sign positioned so as to point to the center of the optional lane, and sloping with the point up at the bottom middle for rest area and scenic view signs.					
Type C arrow is used in advance of a turn.					
"Down" arrow is used pointing down to indicate proper lane use.					
Diagrammatic Freeway Guide Sign Elements:					
Lane Width – 5 inches					
Lane Lines – 1 x 6 inches					
Vertical Space between Lane Lines – 6 inches					
Stem Height (to upper point of departure – minimum) – 30 inches					
Arrowhead – Type A					
Space between Arrow Head and Route Shield – 12 inches					

*Cardinal direction may be reduced to 6 inches with first letter 7.5 inches.

**LEFT shown as black on yellow panel on freeway and expressway mainline guide signs.

on all overhead and post-mounted Exit Direction signs shall point diagonally upward and shall be located on the side of the sign consistent with the direction of the exiting movement.

Option:

- 03 On post-mounted Exit Direction signs that are located where a directional arrow to the side of the legend farthest from the roadway might create an unusually wide sign that limits the road user's view of the arrow, the directional arrow may be placed at the bottom portion of the sign, centered under the legend.

Standard:

- 04 **Directional arrows on guide signs for multi-lane exits shall be positioned below the legend approximately over the center of each lane to which the arrow applies (see Figures 2E-8 through 2E-12 and 2E-14).**
- 05 **On overhead signs where down arrows are used to indicate a lane to be followed, a down arrow shall be positioned approximately over the center of each lane and shall point vertically downward toward the approximate center of that lane. Down arrows shall be used only on overhead guide signs that restrict the use of specific lanes to traffic bound for the destination(s) and/or route(s) indicated by these arrows. Down arrows shall not be used unless an arrow can be located over and pointed to the approximate center of each lane that can be used to reach the destination displayed on the sign.**
- 06 **If down arrows are used, having more than one down arrow pointing to the same lane on a single overhead sign (or on multiple signs on the same overhead sign structure) shall not be permitted.**

Support:

- 07 Directional and down arrows for use on guide signs are shown in Figure 2D-2. Detailed drawings and standardized sizes based on ranges of letter heights for these arrows are provided in the SDMM (see Section 1A.11). Information on the dimensions for arrows used in Overhead Arrow-per-Lane and Diagrammatic guide signing is also provided in the SDMM.

Section 2E.20 Signing for Option Lanes at Splits and Multi-Lane Exits

Support:

- 01 Some freeway and expressway splits or multi-lane exit interchanges contain an interior option lane serving both movements in which traffic can either leave the route or remain on the route, or choose either destination at a split, from the same lane.

Standard:

- 02 **On freeways and expressways, either the Overhead Arrow-per-Lane or Diagrammatic guide sign designs as provided in Sections 2E.21 and 2E.22 shall be used for all multi-lane exits at major interchanges (see Section 2E.32) that have an optional exit lane that also carries the through route (see Figures 2E-4, 2E-5, 2E-8, and 2E-9) and for all splits that include an option lane (see Figures 2E-6 and 2E-10). Overhead Arrow-per-Lane or Diagrammatic guide signs shall not be used on freeways and expressways for any other types of exits or splits, including single-lane exits and splits that do not have an option lane.**

Guidance:

- 03 *The Overhead Arrow-per-Lane guide sign design (see Section 2E.21) should also be considered for multi-lane exits with an option lane at intermediate interchanges (see Section 2E.32) based on such factors as the extent of the need to optimize the mainline operation by maximizing the usage of the option lane, the extent of the period(s) of the day during which the exiting volumes warrant the multi-lane exit arrangement, and the nature of the traffic that primarily uses the option lane during the high-volume periods.*
- 04 *Signing for multi-lane exits at minor interchanges (see Section 2E.32) that have an optional exit lane or at intermediate interchanges that have an optional exit lane at which it has been determined that the Overhead Arrow-per-Lane guide sign design is not warranted should use a combination of conventional guide signing and regulatory lane-use signing, in accordance with the provisions of Section 2E.23.*

Section 2E.21 Design of Overhead Arrow-per-Lane Guide Signs for Option Lanes

Support:

- 01 Overhead Arrow-per-Lane guide signs (see Figure 2E-3) are used where an option lane is present at freeway and expressway multi-lane exit interchanges and splits. They display an upward-pointing arrow

Figure 2E-3. Overhead Arrow-per-Lane Guide Sign for a Multi-Lane Exit with an Option Lane



above each lane that conveys the direction(s) of travel that the lane serves at the point of departure. At locations where an option lane is present at a multi-lane exit or split, Overhead Arrow-per-Lane guide signs have been shown to be superior to either conventional guide signs or Diagrammatic guide signs because they convey positive direction about which destination and direction each approach lane serves, particularly for the option lane, which is otherwise difficult to clearly sign.

Standard:

02 **Overhead Arrow-per-Lane guide signs shall be used on all new or reconstructed freeways and expressways as described in Section 2E.20.**

03 **Where used, the Overhead Arrow-per-Lane guide sign at the exit or split shall be located at or in the immediate vicinity of the point where the exiting lanes begin to diverge from the through lanes or, for a split, at the point where the approach lanes begin to diverge from one another, preserving the relation of the arrows displayed on the sign to their respective lanes. The Overhead Arrow-per-Lane guide sign at the exit shall not be located at or near the theoretical gore.**

Option:

04 **At existing or non-reconstructed locations where Exit Direction and Pull-Through signs exist at the theoretical gore, the existing sign support structure may remain in place, continuing to use Exit Direction and Pull-Through signs, in conjunction with a replacement of the advance signs using the Overhead Arrow-per-Lane guide sign design.**

Standard:

05 **If existing Exit Direction and Pull-Through signs are being retained at an interchange as provided in Paragraph 4, an Overhead Arrow-per-Lane guide sign shall not be used at the location of the Exit Direction and Pull-Through signs at or in the vicinity of the theoretical gore. New installations of Exit Direction and Pull-Through signs shall not be permitted in conjunction with Overhead Arrow-per-Lane guide signs on new or reconstructed facilities.**

Guidance:

06 *Overhead Arrow-per-Lane guide signs should be located at approximately 1/2 mile and 1 mile in advance of the exit or split, and at approximately 2 miles in advance of the exit or split where space is available and there is an operational need.*

Standard:

07 **Overhead Arrow-per-Lane guide signs used on freeways and expressways shall include one arrow above each lane and shall be designed in accordance with the following criteria:**

Figure 2E-4. Overhead Arrow-per-Lane Guide Signs for a Two-Lane Exit to the Right with an Option Lane

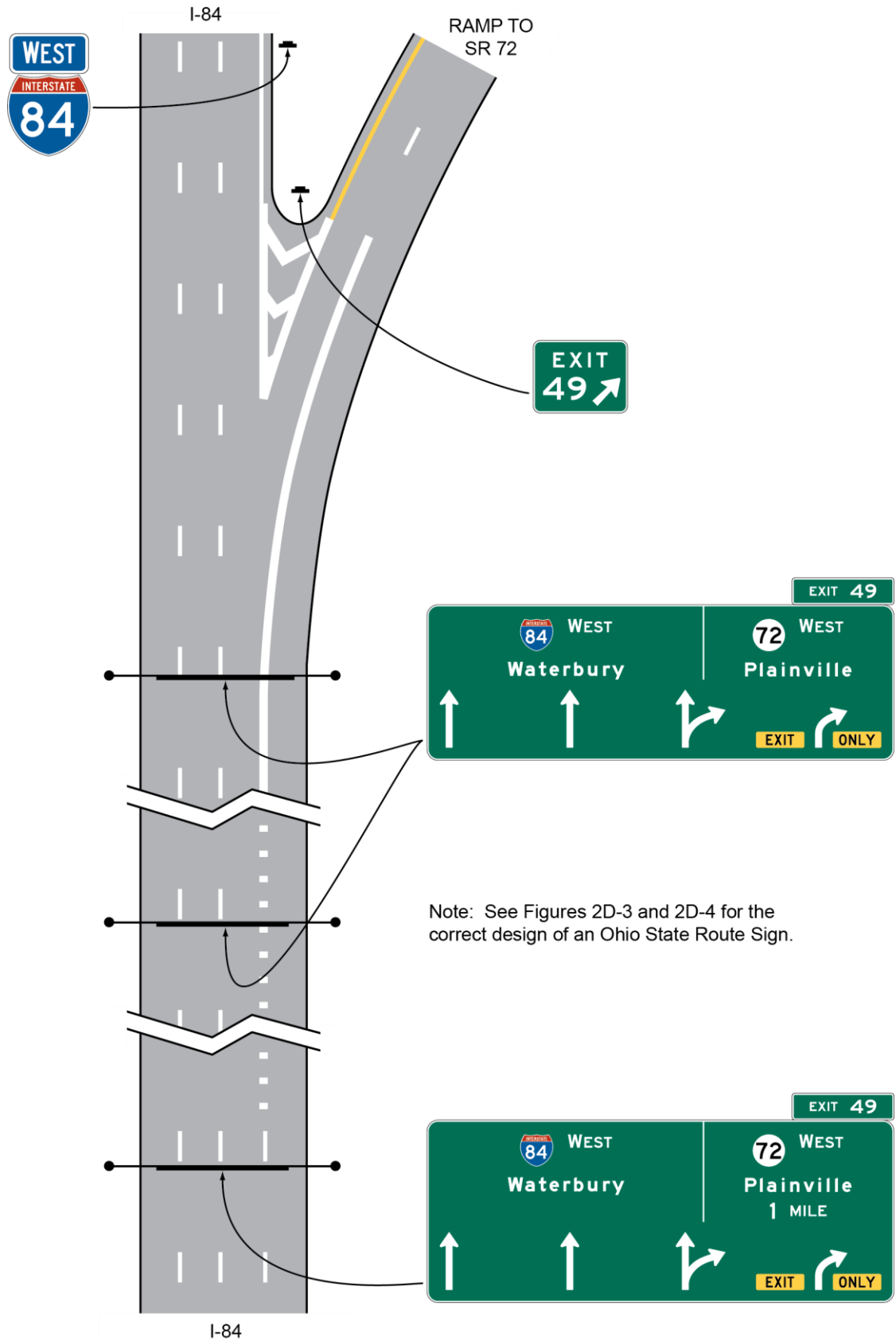

Figure 2E-5. Overhead Arrow-per-Lane Guide Signs for a Two-Lane Exit to the Right with an Option Lane (Through Lanes Curve to the Left)

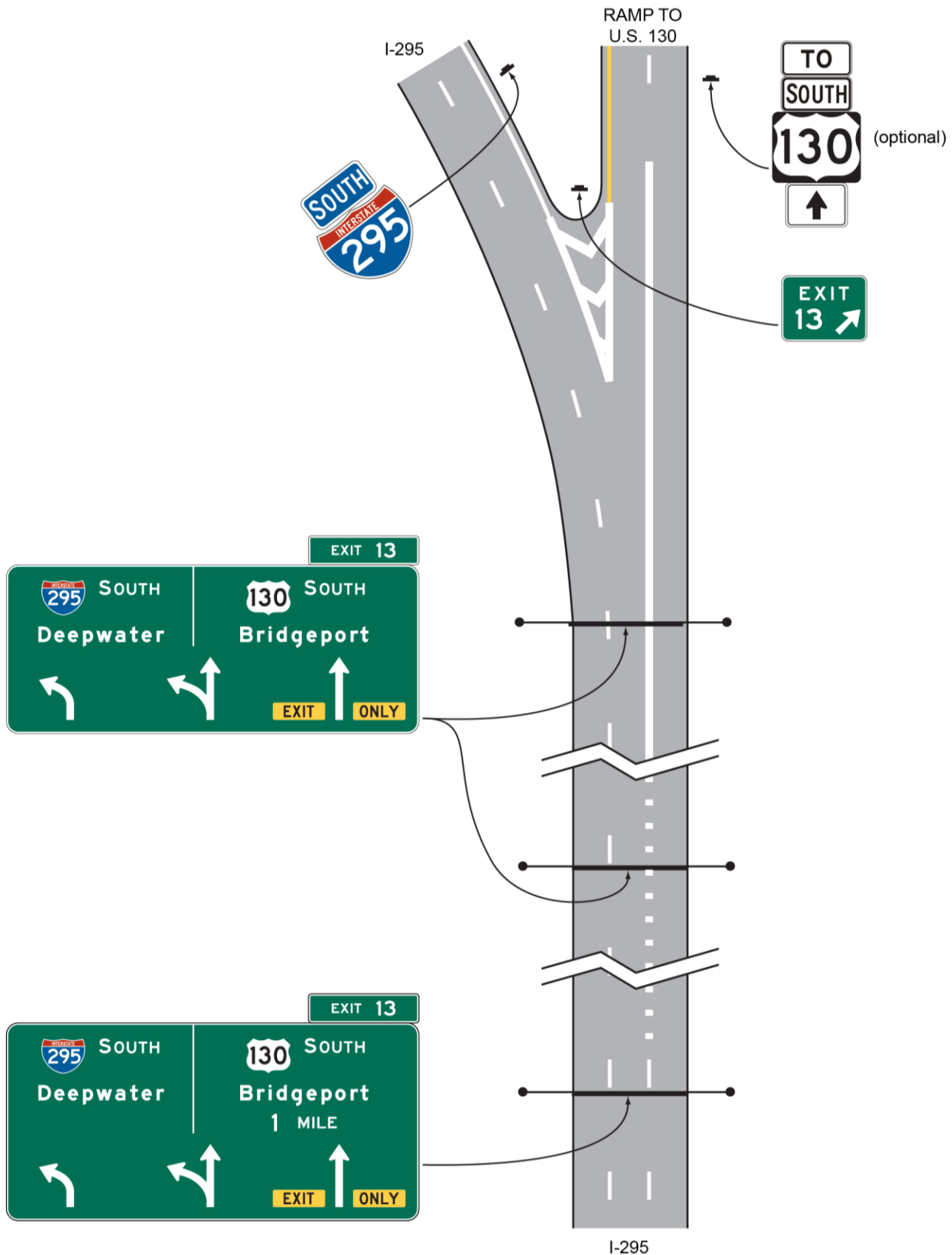
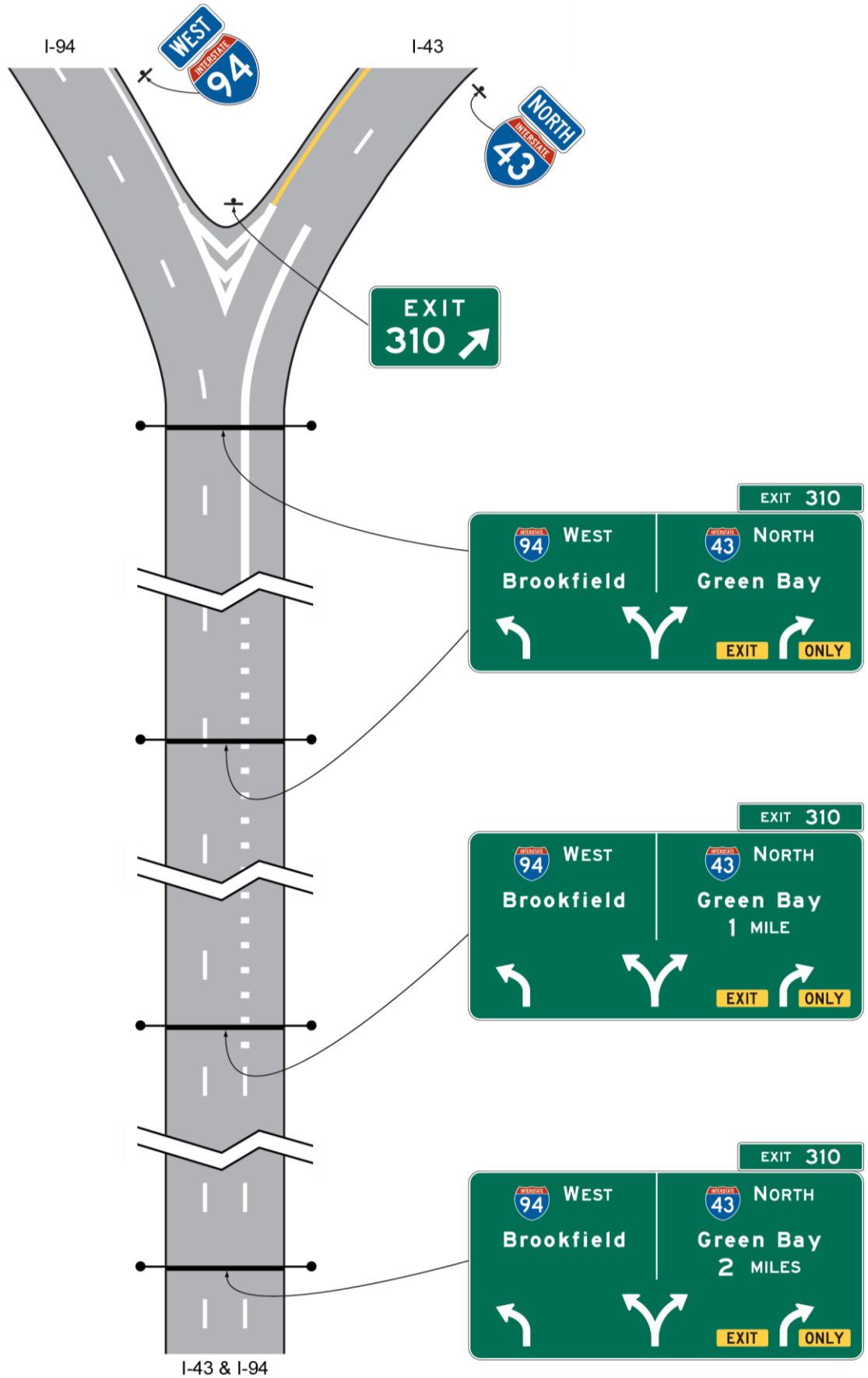

Figure 2E-6. Overhead Arrow-per-Lane Guide Signs for a Split with an Option Lane



- A. The sign shall include an upward-pointing arrow for each lane of the approach to the split or exit, and the shaft of each arrow shall be located approximately over the center of the lane to which it applies.
- B. Arrows for continuing through lanes shall be vertically upward pointing (see Figure 2E-4) unless those lanes are on a significantly curved alignment beyond the theoretical gore, in which case the arrows for the continuing through lanes shall indicate the approximate degree of curvature (see Figure 2E-5).
- C. The arrow for a lane that must exit shall be curved in the direction of the exit and shall be accompanied by black-on-yellow EXIT (E11-1a) and ONLY (E11-1b) sign panels adjacent to the lower end of the arrow shaft. The E11-1a and E11-1b sign panels shall not be used for a split of two overlapping routes where neither of the diverging routes is designated as an exit. Where the through lanes curve and the exit continues on a straight alignment, upward-pointing vertical arrows shall be used for the exiting movement and curved arrows for the through movement.
- D. The arrow for an optional exit lane that also carries the through route shall have a single shaft that bifurcates into a vertically upward-pointing arrow and a curving arrow corresponding to the configuration of the through and exit lanes.
- E. For splits with an option lane, the arrow for the lane from which either direction of the split can be accessed shall have a single shaft that bifurcates into two upward-pointing curving arrows showing the approximate degrees of curvature of the two roadways beyond the theoretical gore (see Figure 2E-6).
- F. A vertical white line shall be used to separate the route shields and destinations for the two diverging movements from each other.
- G. The distance to the exit or split shall be displayed below the off-movement destination on the advance signs at the 1-mile and 2-mile locations.
- H. The number of lanes displayed on a sign shall correspond to the number of lanes at the location of that sign. An advance sign shall not depict lanes that are added downstream of a sign location.
- I. For numbered exits, the Exit Number (E1-5P) or Left Exit Number (E1-5bP) plaque shall be used at the top of the sign in accordance with Section 2E.31. For unnumbered left exits, the LEFT (E1-5aP) plaque shall be used at the top left edge of the sign.

Guidance:

- 08 *Overhead Arrow-per-Lane guide signs used on freeways and expressways should be designed in accordance with the following additional criteria:*
- A. *No more than one destination should be displayed for each movement, and no more than two destinations should be displayed per sign.*
 - B. *The arrowhead(s) for the diverging movement should be positioned lower on the sign than the arrowhead(s) for the movement that continues straight ahead, independent of which movement carries the through route. Where the movements are freeway or expressway splits rather than exits, the arrowheads should be positioned at approximately the same height on the sign.*
 - C. *Route shields, cardinal directions, and destinations should be positioned on the sign such that they are clearly related to the arrowhead(s) for the movement to which they apply.*
 - D. *The cardinal direction should be placed adjacent to the route shield for exits or splits leading in a single cardinal direction.*
 - E. *The vertical white line that is used to separate the route shields and destinations for the two diverging movements from each other should not descend below the top of the arrowheads for the through lanes, and should be positioned approximately halfway between the diverging arrowheads for the optional movement lane (see Figure 2E-3).*

Standard:

- 09 **Overhead Arrow-per-Lane guide signs shall not be used to depict a downstream split of an exit ramp on a sign located on the mainline.**

Figure 2E-7. Diagrammatic Guide Sign for a Multi-Lane Exit with an Option Lane**Support:**

- 10 Specific guidelines for more detailed design of Overhead Arrow-per-Lane guide signs are contained in the “Sign Designs and Markings Manual” (SDMM) (see Section 1A.11).

Option:

- 11 Where extra emphasis of an especially low advisory ramp speed is needed, an EXIT XX MPH (E13-2) sign panel (see Figure 2E-27) may be placed below the applicable destination legend to supplement, but not to replace, the exit or ramp advisory speed warning signs.

Section 2E.22 Design of Freeway and Expressway Diagrammatic Guide Signs for Option Lanes

Support:

- 01 Diagrammatic guide signs (see Figure 2E-7) are guide signs that show a simplified graphic view of the exit arrangement in relationship to the main highway. While the use of such guide signs might be helpful for the purpose of conveying relative direction of each movement. Diagrammatic guide signs have been shown to be less effective than conventional or Overhead Arrow-per-Lane guide signs at conveying the destination or direction(s) that each approach lane serves, regardless of whether dedicated or option lanes are present.

Standard:

- 02 **Diagrammatic guide signs used where an option lane is present at a freeway or expressway split or multi-lane exit shall be designed in accordance with the following criteria:**
- A. The graphic legend shall be of a plan view showing the off-ramp arrangement.
 - B. No other symbols or route shields shall be used as a substitute for arrowheads.
 - C. They shall not be installed at the Exit Direction sign location (see Section 2E.36).
 - D. The EXIT ONLY sign panel shall not be used on diagrammatic guide signs in advance of the interchange.
 - E. For numbered exits, the Exit Number (E1-H5P) or Left Exit Number (E1-H5bP) plaque shall be used at the top of the sign in accordance with Section 2E.31. For unnumbered left exits, the LEFT (E1-5aP) plaque shall be used at the top left edge of the sign.
 - F. The EXIT ONLY (E11-1e or E11-1f) sign panels shall be used on the Exit Direction sign at the theoretical gore, except at splits of two overlapping routes where neither of the routes is designated as an exit.

Guidance:

- 03 *Diagrammatic guide signs used on freeways and expressways should be designed in accordance with the following additional criteria:*
- A. *The graphic should not depict deceleration lanes.*

Figure 2E-8. Diagrammatic Guide Signs for a Two-Lane Exit to the Right with an Optional Lane

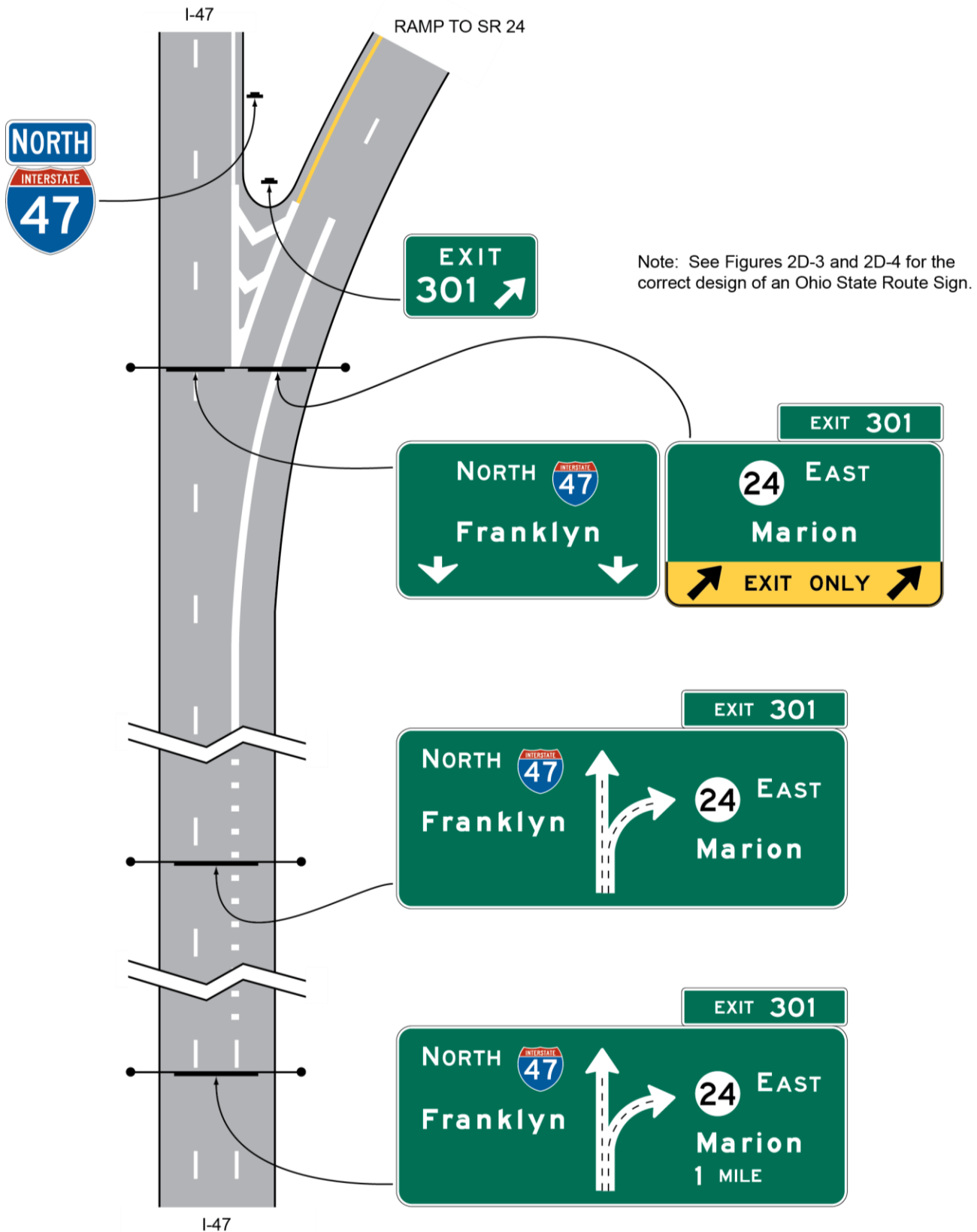

Figure 2E-9. Diagrammatic Guide Signs for a Two-Lane Exit to the Right with an Optional Lane (Through Lanes Curve to the Left)

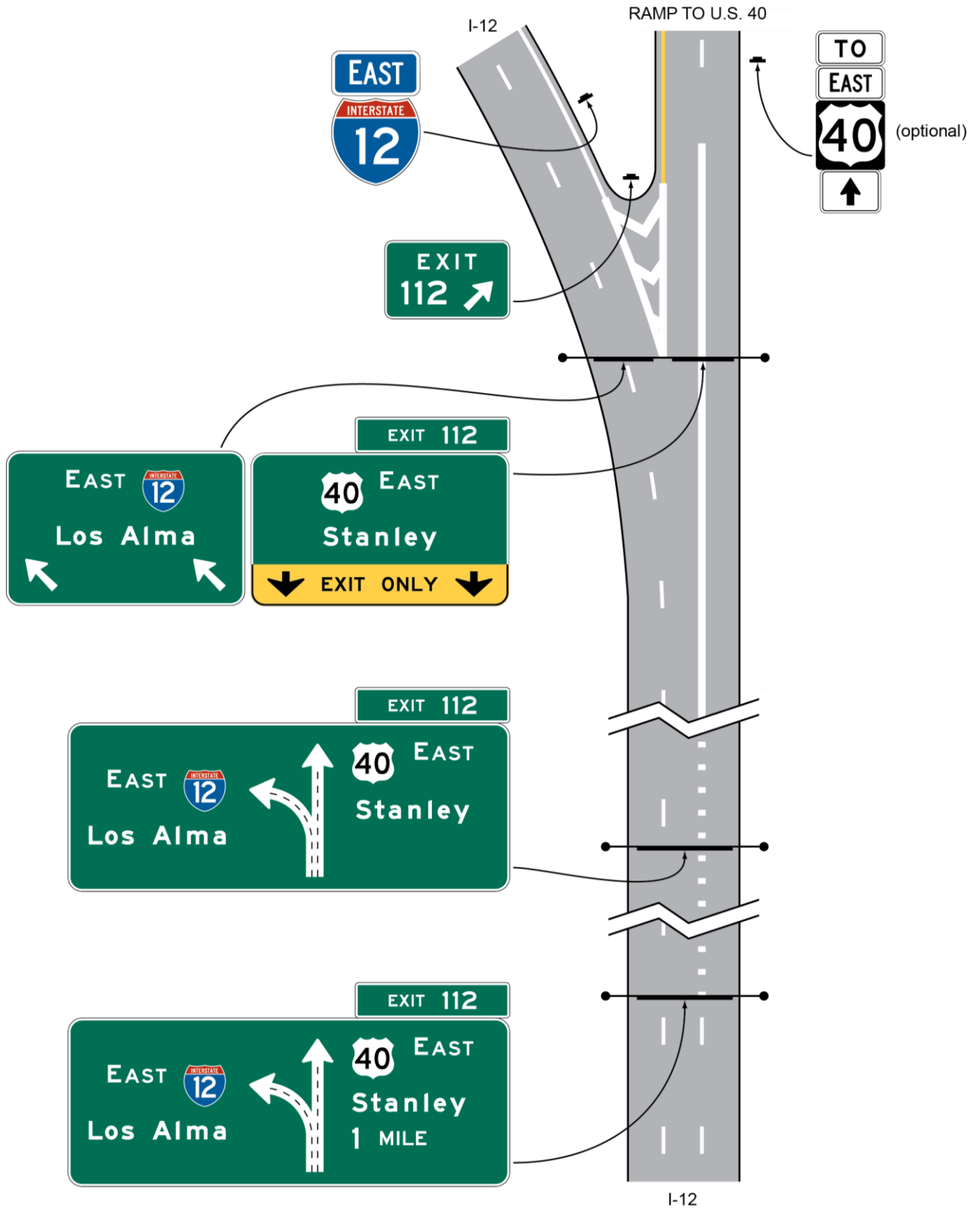
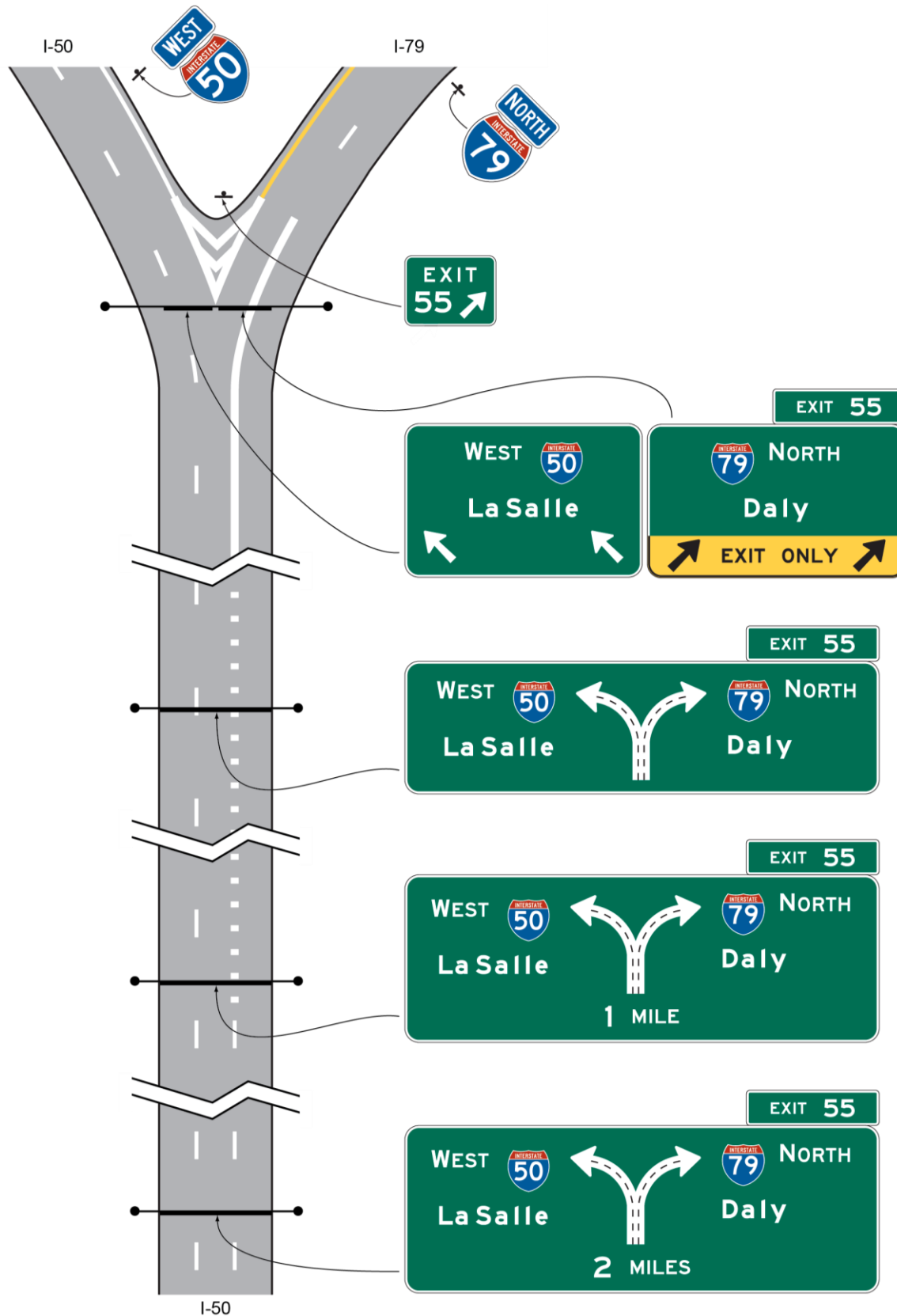

Figure 2E-10. Diagrammatic Guide Signs for a Split with an Option Lane



- B. *No more than one destination should be displayed for each movement and no more than two destinations should be displayed per sign.*
- C. *The arrowhead for the diverging movement should be positioned lower on the sign than the arrowhead for the movement that continues straight ahead, independent of which movement carries the through route (see Figures 2E-8 and 2E-9). Where the movements are freeway or expressway splits rather than exits, the arrowheads should be positioned at approximately the same height on the sign (see Figure 2E-10).*
- D. *Arrow shafts should contain lane lines.*
- E. *Route shields, cardinal directions, and destinations should be positioned on the sign such that they are clearly related to the arrowhead(s), and the arrowhead for the off movement should point toward the route shield for the off movement.*
- F. *For exits or splits leading in a single direction, the cardinal direction should be placed adjacent to the route shield, and the destination should be placed below the route shield and cardinal direction.*

Standard:

- 04 **Diagrammatic guide signs shall not be used at cloverleaf interchanges for the purpose of depicting successive departures from the mainline or separate downstream departures from a collector-distributor roadway. The use of Diagrammatic guide signs at cloverleaf interchanges shall be limited to the following cases:**
- A. **Where the outer (non-loop) exit ramp of the cloverleaf is a multi-lane exit having an optional exit lane that also carries the through route; and**
 - B. **At cloverleaf interchanges that include collector-distributor roadways, such as those illustrated in Figure 2E-36, that are accessed from the mainline by a multi-lane exit having an optional exit lane that also carries the through route. In this case, the Diagrammatic guide sign shall only show the configuration of the lanes at the exit point to the collector-distributor roadway and not the entire interchange configuration.**

Support:

- 05 Specific guidelines for more detailed design of Diagrammatic guide signs are contained in Appendix C of the SDMM (see Section 1A.11).

Option:

- 06 Where extra emphasis of an especially low advisory ramp speed is needed, an EXIT XX MPH (E13-2) sign panel (see Figure 2E-27) may be placed below the applicable destination legend to supplement, but not to replace, the exit or ramp advisory speed warning signs.

Section 2E.23 Signing for Intermediate and Minor Interchange Multi-Lane Exits with an Option Lane

Support:

- 01 Intermediate and minor multi-lane exits might have an operational need for the presence of an option lane for only the peak period during which excessive queues might otherwise develop if the option lane were not available. In such cases, the Overhead Arrow-per-Lane or Diagrammatic guide signing described for option lanes in Sections 2E.21 and 2E.22 might not be practical, depending on the level of use of the option lane and the spacing of nearby interchanges, particularly in non-rural areas.

Guidance:

- 02 *Signing for an intermediate or minor interchange that has a multi-lane exit with an option lane that also carries the through route should use the same basic principles as those for a conventional exit (a single lane exit without an option lane). In such cases, the option lane is not signed on the Advance Guide signs. For such exits that involve the addition of an auxiliary lane that is not present at the Advance Guide sign locations, but do not involve a lane drop (see Figure 2E-12), a sequence of post-mounted or overhead-mounted Advance Guide signs should be used, located in accordance with the interchange classification (see Section 2E.32). The Exit Direction sign should be located at the theoretical gore and display a diagonally upward-pointing directional arrow above each lane that departs from the mainline alignment. The Exit Direction sign should not contain the EXIT ONLY legend.*

Figure 2E-11. Example of Signing for a Two-Lane Intermediate or Minor Interchange Exit with an Option Lane and a Dropped Lane

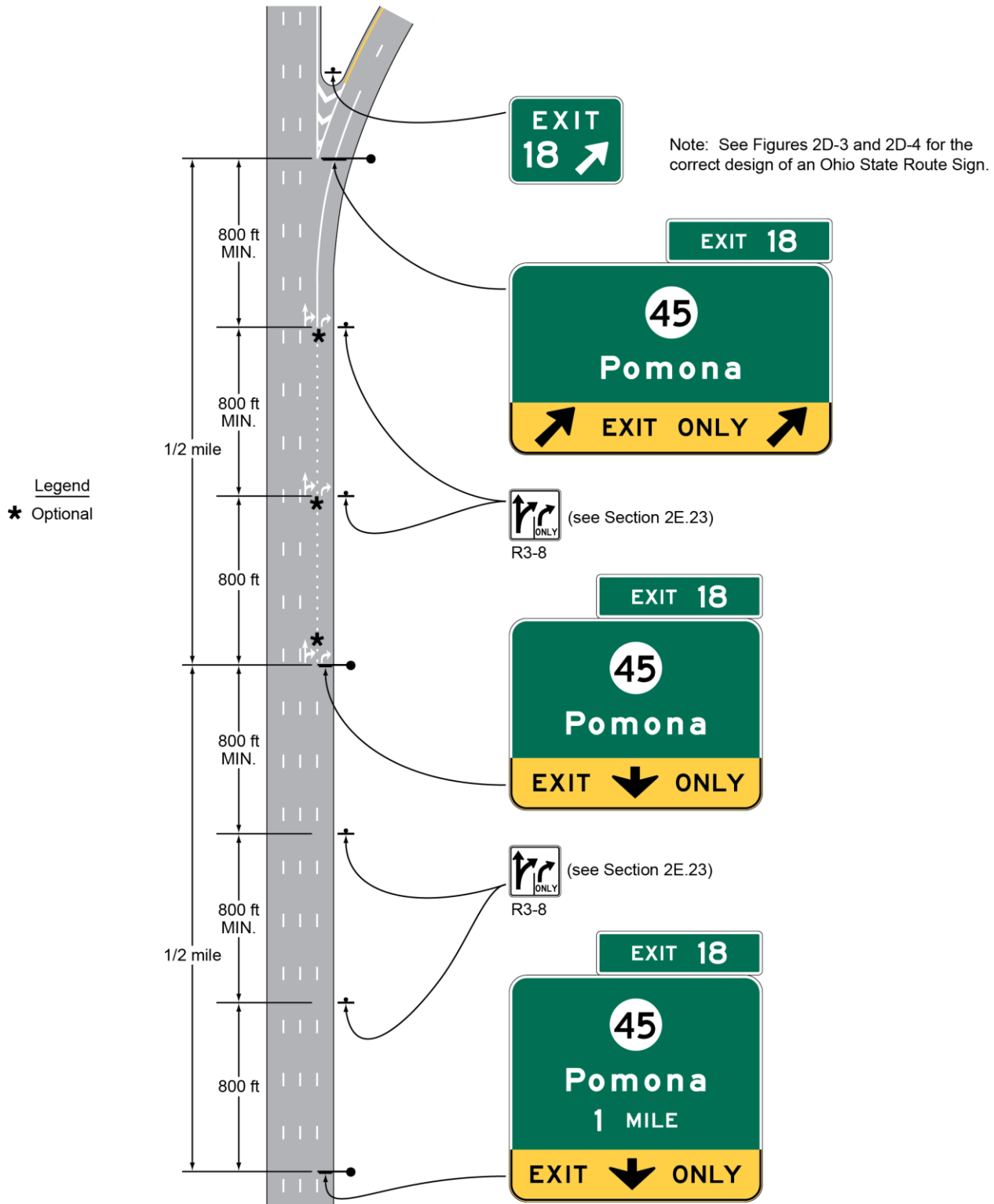

Figure 2E-12. Example of Signing for a Two-Lane Intermediate or Minor Interchange Exit with Option and Auxiliary Lanes

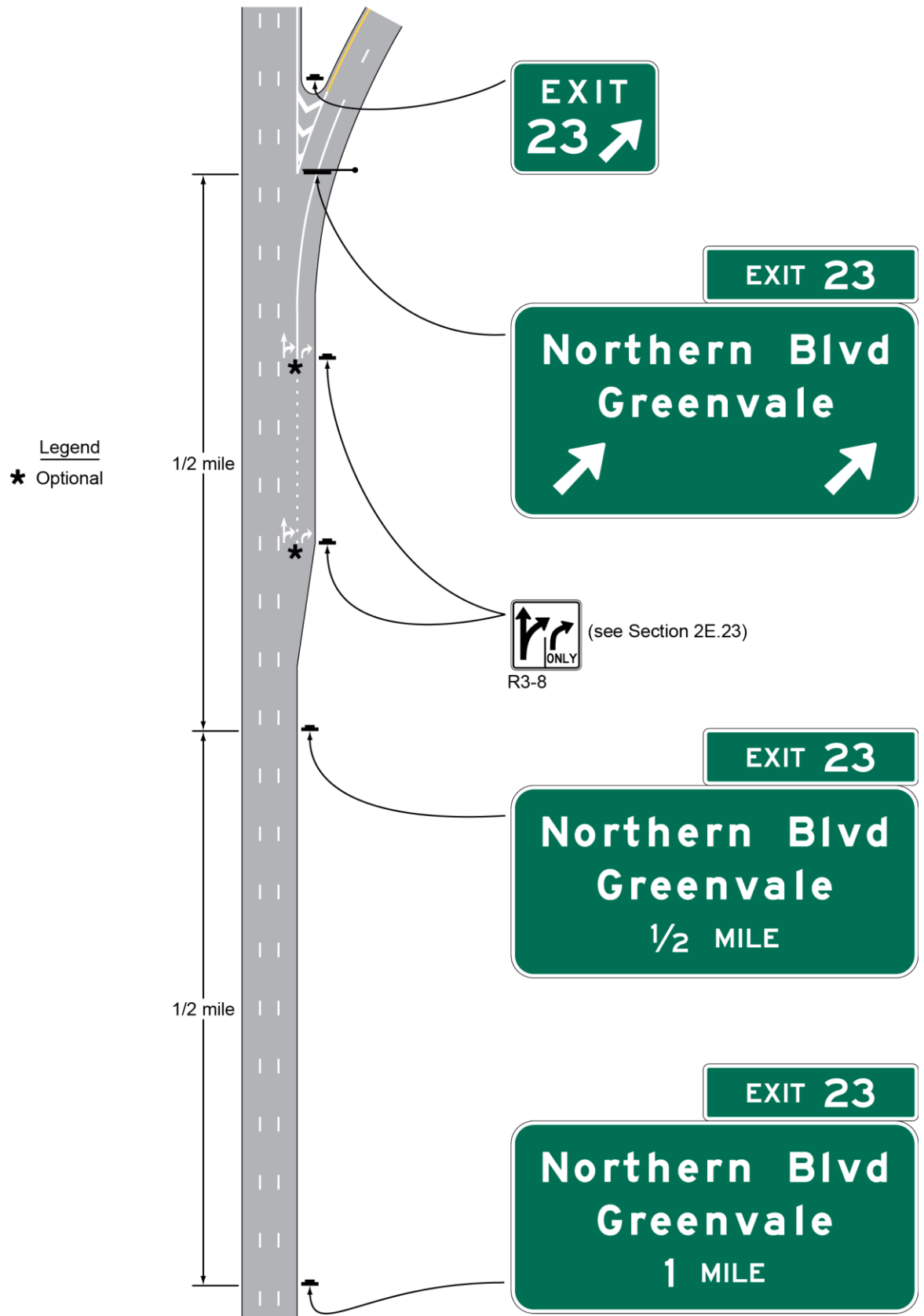
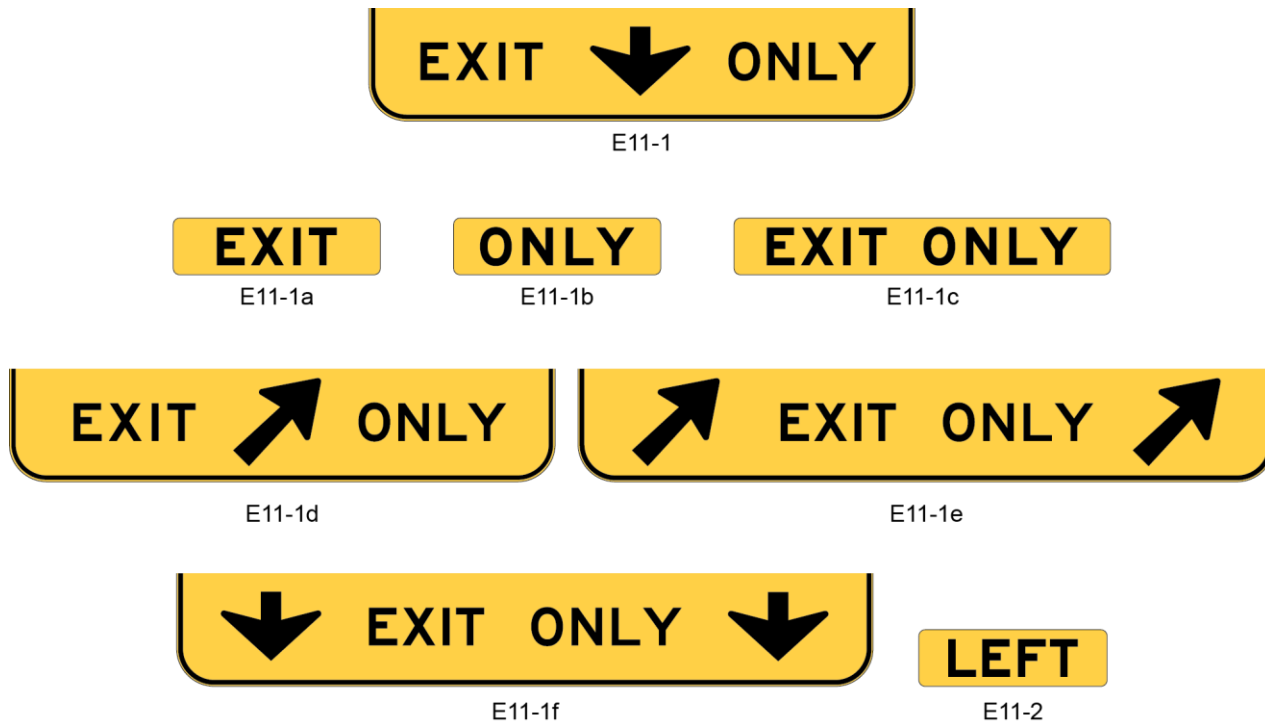

Figure 2E-13. EXIT ONLY and LEFT Sign Panels

03 For such interchanges that also have a lane drop (see Figure 2E-11), the Advance Guide and Exit Direction signs should follow the provisions of Section 2E.24. The Exit Direction sign should be located at the theoretical gore and should contain the EXIT ONLY (E11-1e) sign panel.

04 The presence of the option lane should be conveyed by the use of post-mounted lane-use (R3-8 Series) signs (see Section 2B.22). When used, the R3-8 signs should be of an appropriate size for their application to optimize their conspicuity. The signs should be located in succession with the Advance Guide signs, where the option and exit lanes have developed (see Figure 2E-11). In cases where the exiting lane or lanes have not developed and the option lane is created by the addition of an auxiliary lane that exits, the R3-8 signs should be located only adjacent to where the lanes have been fully developed and not in advance of the lane or along its transition (see Figure 2E-12).

Support:

05 The use of a down arrow on overhead freeway or expressway guide signs has been shown to be misinterpreted by road users as an indication of a dedicated lane.

Standard:

06 **Advance Guide signs that are mounted overhead shall not display a down arrow over an option lane.**

Section 2E.24 Signing for Interchange Lane Drops

Standard:

01 **The provisions of this Section shall only apply to lane drops at exits that do not have an optional exit lane. At exits that have an optional exit lane in addition to the dropped lane, the provisions of Sections 2E.20 through 2E.23 shall apply.**

02 **Major guide signs for all lane drops at interchanges shall be mounted overhead. An EXIT ONLY sign panel shall be used for all interchange lane drops at which the through route is carried on the mainline.**

Figure 2E-14. Guide Signs for a Split with Dedicated Lanes

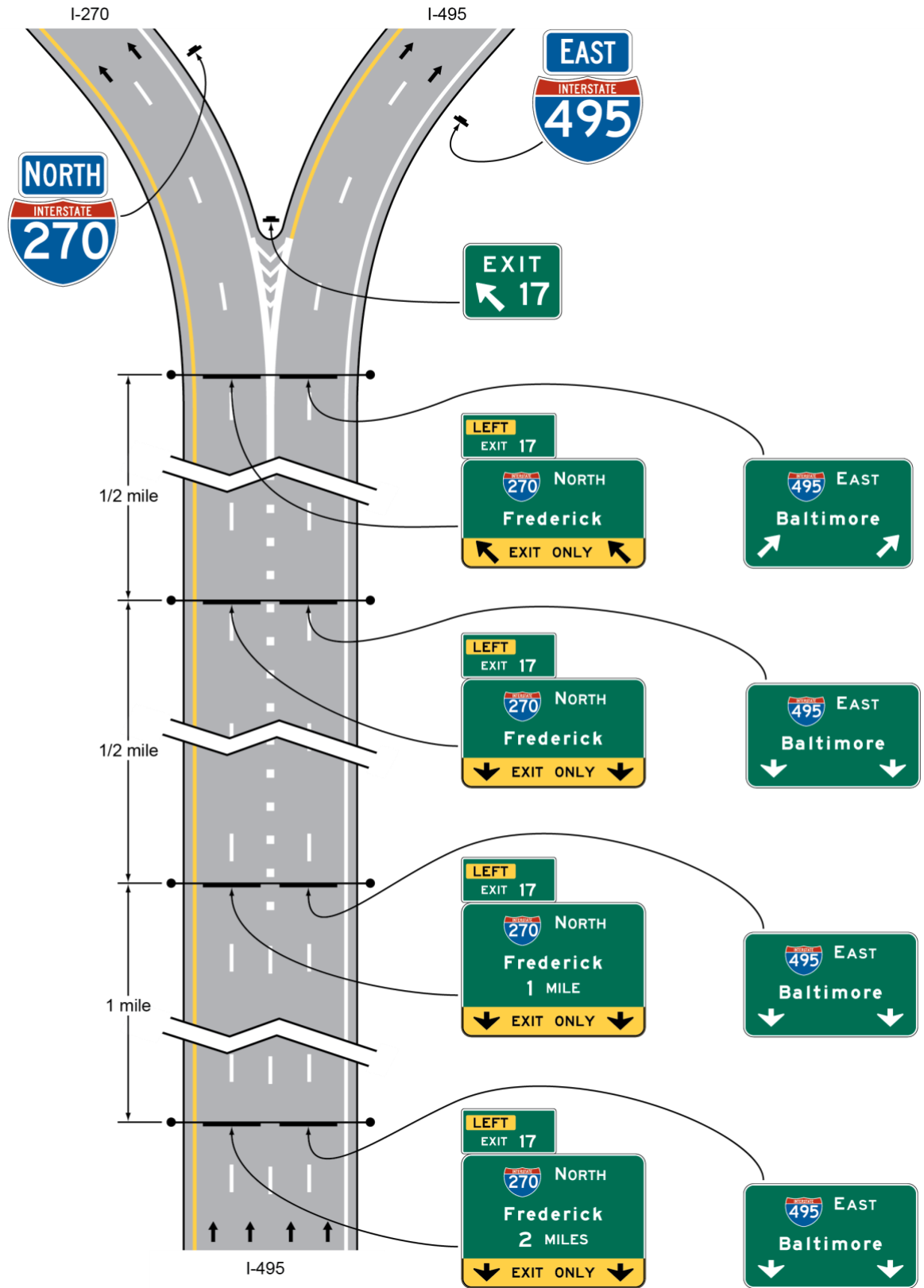

Figure 2E-15. Guide Signs for a Single-Lane Exit to the Left with a Dropped Lane

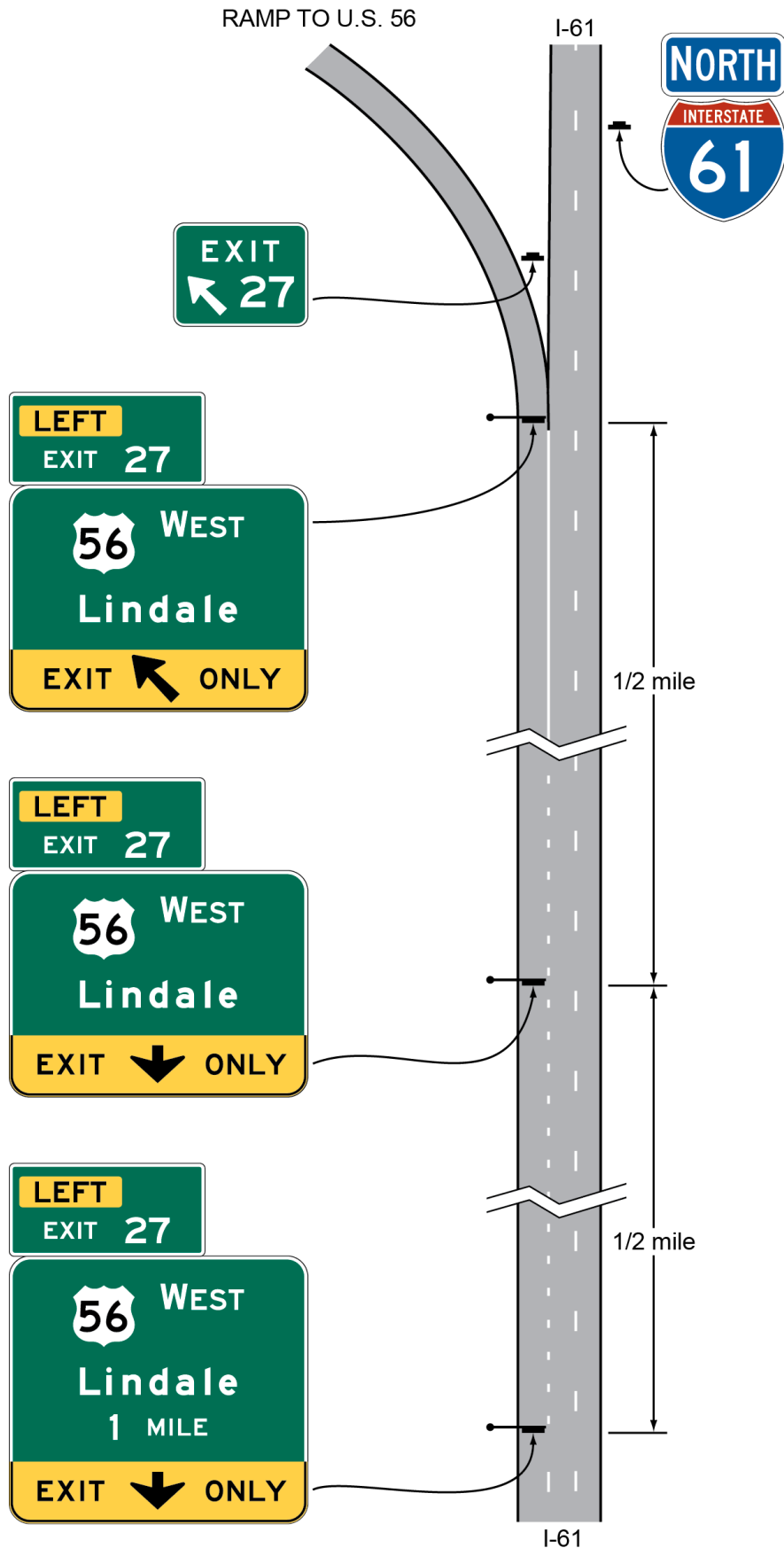
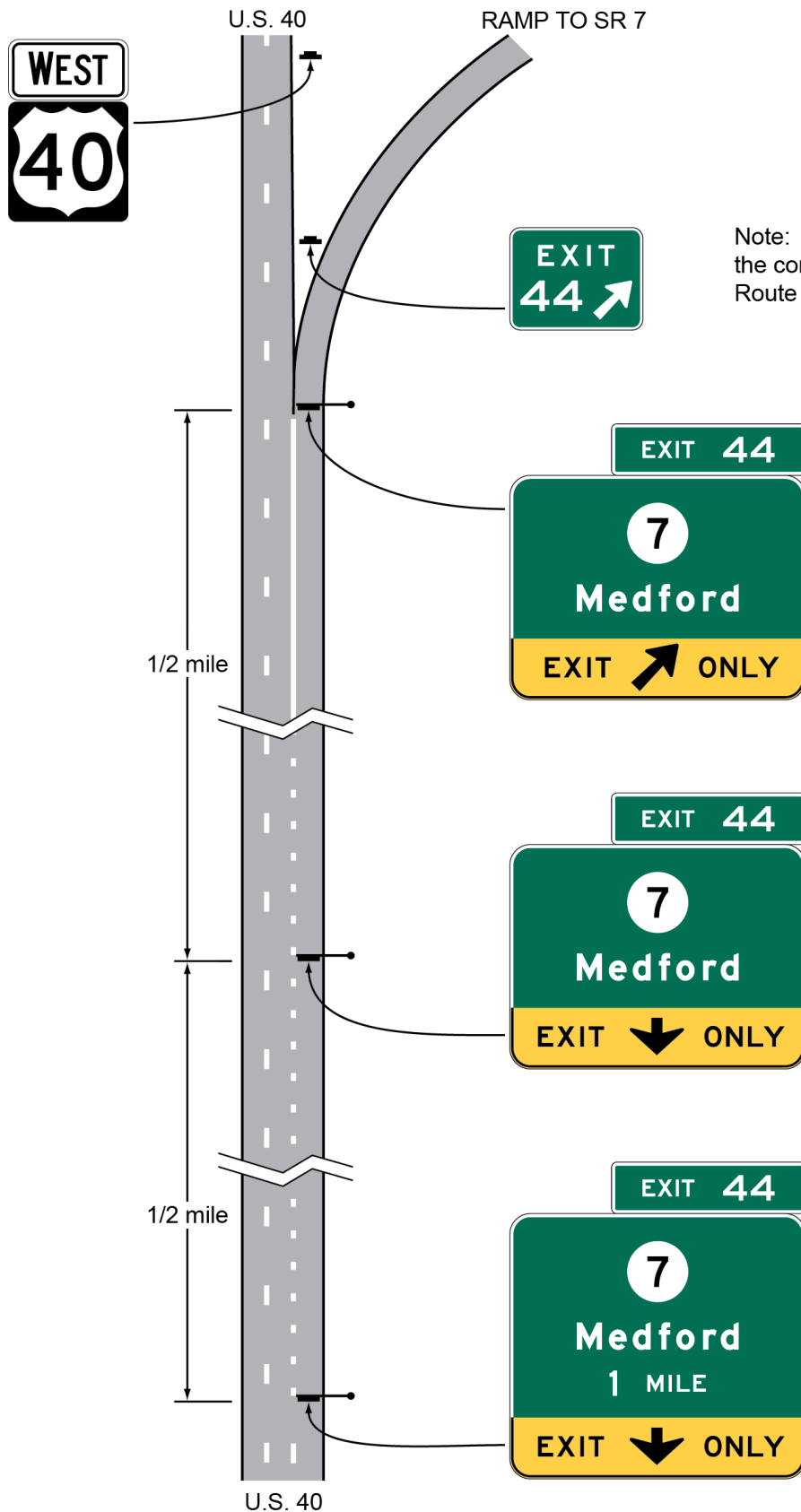

Figure 2E-16. Guide Signs for a Single-Lane Exit to the Right with a Dropped Lane



03 **Except on Overhead Arrow-per-Lane and Diagrammatic guide signs (see Sections 2E.20 through 2E.22), the EXIT ONLY(down arrow) (E11-1 or E11-1f) sign panel (see Figure 2E-13) shall be used on all signing of lane drops on all overhead Advance Guide signs (see Figures 2E-14 through 2E-16). The number of arrows on each sign shall correspond to the number of dropped lanes at the location of each sign. Placement of the down arrow shall comply with the provisions of Section 2E.19.**

04 **For lane drops, the Exit Direction sign (see Section 2E.36 and Figure 2E-26) shall be of the format shown in Figures 2E-15 and 2E-16. The bottom portion of the Exit Direction sign shall be yellow with a black border and shall include a diagonally upward-pointing black directional arrow (left or right) for each lane dropped at the exit, with the sign designed and placed so that each arrow is located over the approximate center of each lane being dropped. The words EXIT and ONLY shall be positioned to the left and right, respectively, of the arrow on the E11-1d sign panel for a single-lane drop. For a two-lane drop, the words EXIT ONLY shall be located between the two arrows on the E11-1e sign panel. The number of arrows on the sign shall correspond to the number of dropped lanes at the location of the sign.**

Guidance:

05 *On the yellow portion of the Advance Guide and Exit Direction signs, the black border should extend to the edge of the signs to provide continuity with the white border on the green portion of the signs.*

Option:

06 EXIT ONLY messages of either the combination of E11-1a and E11-1b, or E11-1c formats may be used to retrofit existing signing to warn of a lane drop situation ahead.

Standard:

07 **If used to retrofit an existing Advance Guide sign, the E11-1a and E11-1b sign panels (see Figure 2E-13) shall be placed on either side of a white down arrow. The E11-1c sign panel, if used to retrofit an existing sign, shall be placed between the lower destination message and the white down arrow.**

Guidance:

08 *Except as provided in Paragraph 9 for an auxiliary lane, Advance Guide signs for lane drops within 1 mile of the interchange should not contain the distance message.*

09 *Where the dropped lane is an auxiliary lane that is provided between successive entrance and exit ramps of two separate interchanges and the distance between the two ramps is less than 1 mile, the first Advance Guide sign in the sequence downstream from the entrance ramp should contain the distance message.*

10 *Wherever the dropped lane carries the through route, signs should be used without the EXIT ONLY sign panel.*

Support:

11 Sections 2E.20 through 2E.23 contain information on the signing of lane drops at exits that also have an option lane.

12 Section 2B.23 contains information regarding regulatory signs that can also be used for freeway lane drop situations and Section 2C.43 contains information regarding warning signs that can also be used for freeway lane drop situations.

Section 2E.25 Overhead Sign Installations

Support:

01 Specifications for the design and construction of structural supports for signs have been standardized by the American Association of State Highway and Transportation Officials (AASHTO). Overcrossing structures can often serve for the support of overhead signs, and might in some cases be the only practical location that will provide adequate viewing distance. Use of these structures as sign supports will eliminate the need for additional sign supports along the roadside. Factors justifying the installation of overhead signs are given in Section 2A.17. Vertical clearance of overhead signs is discussed in Section 2A.18.

Section 2E.26 Lateral Offset

Standard:

01 **The minimum lateral offset outside the usable roadway shoulder for post-mounted freeway and expressway signs or for overhead sign supports, either to the right-hand or left-hand side of the**

roadway, shall be 6 feet. This minimum clearance shall also apply outside of a curb. If located within the clear zone, the signs shall be mounted on crashworthy supports or shielded by appropriate crashworthy barriers.

Guidance:

02 Where practical, a sign should not be less than 10 feet from the edge of the nearest traffic lane. Large guide signs especially should be farther removed, preferably 30 feet or more from the nearest traffic lane.

03 When using an overhead sign support, where an expressway median is 12 feet or less in width, consideration should be given to spanning both roadways without a center support.

04 Where overhead sign supports cannot be placed sufficiently far away from the line of traffic or in an otherwise protected site, they should either be designed to minimize the impact forces, or be adequately shielded by a traffic barrier of suitable design.

Standard:

05 Butterfly-type sign supports and other overhead non-crashworthy sign supports shall not be installed in gores or other unshielded locations within the clear zone.

Option:

06 Lesser clearances, but not generally less than 6 feet, may be used on connecting roadways or ramps at interchanges.

Section 2E.27 Route Signs and Trailblazer Assemblies

Standard:

01 The official Route sign for the Interstate Highway System shall be the red, white, and blue retroreflective distinctive shield adopted by the American Association of State Highway and Transportation Officials (see Section 2D.11).

Guidance:

02 Route signs (see Figure 2E-17) should be incorporated as cut-out shields or other distinctive shapes on large directional guide signs. Where the Interstate shield is displayed in an assembly or on the face of a guide sign with U.S. or State Route signs, the Interstate numeral should be at least equal in size to the numerals on the other Route signs. The use of independent Route signs should be limited primarily to route confirmation assemblies.

Figure 2E-17. Interstate, Off-Interstate and U.S. Route Signs

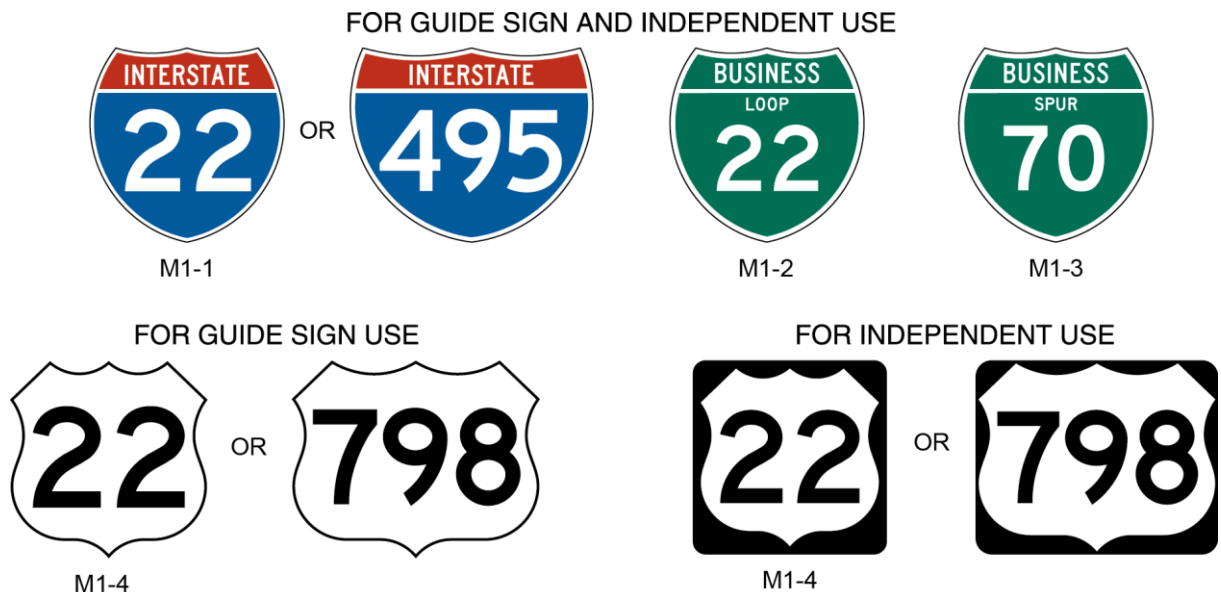

03 *Route signs and auxiliary signs showing junctions and turns should be used for guidance on approach roads, for route confirmation just beyond entrances and exits, and for reassurance along the freeway or expressway. When used along the freeway or expressway, the Route signs should be enlarged to a 36 x 36-inch minimum size for routes with one or two digits and to a 45 x 36-inch minimum size for routes with three digits as shown in the SDMM (see Section 1A.11). When independently mounted Route signs are used in place of Pull-Through signs, they should be located just beyond the exit.*

Option:

04 The standard Trailblazer Assembly (see Section 2D.35) may be used on roads leading to the freeway or expressway. Component messages of the Trailblazer Assembly may be included on a single sign in accordance with the provisions of Section 2D.12. Independently mounted Route signs may be used instead of Pull-Through signs (see Section 2E.12) as confirmation information.

Support:

05 Section 2H.07 contains information regarding the design of signs for Auto Tour Routes.

Option:

06 The commonly used name or trailblazer route sign for a toll highway (see Chapter 2F) may be displayed on non-toll sections of the Interstate Highway System at:

- A. The last exit before entering a toll section of the Interstate Highway System;
- B. The interchange or connection with a toll highway, whether or not the toll highway is a part of the Interstate Highway System; and
- C. Other locations within a reasonable approach distance of toll highways when the name or trailblazer symbol for the toll highway would provide better guidance to road users unfamiliar with the area than would place names and route numbers.

07 The toll highway name or route sign may be included as a part of the guide sign installations on intersecting highways and approach roads to indicate the interchange with a toll section of an Interstate route. Where needed for the proper direction of traffic, a trailblazer for a toll highway that is part of the Interstate Highway System may be displayed with the Interstate Trailblazer Assembly.

Support:

08 Chapter 2F contains additional information regarding signing for toll highways.

Section 2E.28 Eisenhower Interstate System Signs (M1-10)

Option:

01 The Eisenhower Interstate System (M1-10) sign (see Figure 2E-18) may be used on Interstate highways at periodic intervals and in rest areas, scenic overlooks, or other similar roadside facilities on the Interstate Highway System.

Standard:

02 **The M1-10 signs shall not be used as part of a Junction, Advance Route Turn, Directional, or Trailblazer Assembly or as part of a guide sign or similar assembly providing direction to a route or destination.**

Section 2E.29 Signs for Intersections at Grade

Guidance:

01 *Except as noted in Subsections 2E.29.1, if there are intersections at grade within the limits of an expressway, guide sign types provided in Chapter 2D should be used. However, such signs should be of a size compatible with the size of other signing on the expressway.*

Option:

02 Advance Guide signs for intersections at grade may take the form of diagrammatic layouts depicting the geometrics of the intersection along with essential directional information.

Support:

03 Additional information about this type of signing on ODOT-maintained highways is provided in Part 2 of ODOT's "Traffic Engineering Manual" (see Section 1A.11).



Section 2E.29.1 Expressway Street Name Sign (D3-H3 or D3-H3a)

Support:

- 01 Expressway Street Name (D3-H3 or D3-H3a) signs identify expressway at-grade intersections.

Guidance:

- 02 *An Expressway Street Name sign should be installed in urban areas at all important expressway at-grade intersections regardless of other route signs that might be present, and should be installed in rural areas to identify important routes that are not otherwise signed.*

Option:

- 03 For added guidance, an additional Expressway Street Name (D3-H3 or D3-H3a) sign may be installed in advance of the intersection. If used, this additional sign may be placed approximately 500 feet in advance of the intersection.
- 04 The Street Name (D3-1) sign (see Section 2D.43) may be used as an alternative to the D3-H3 or D3-H3a sign at intersections where, for example, the larger sign might adversely affect cross-corner sight distance.

Section 2E.29.2 Expressway At-Grade Intersection Advance Street Name Sign (D3-H4)

Support:

- 01 Expressway At-Grade Intersection Advance Street Name (D3-H4) signs identify an upcoming expressway at-grade intersection.

Guidance:

- 02 *An Advance Street Name (D3-H4) sign should be installed in advance of all important expressway intersections not otherwise signed. The sign should be placed approximately 1/2 mile, or other suitable distance based on engineering judgment, in advance of the intersection.*

Standard:

- 03 **Advance Street Name signs, if used, shall supplement rather than be used instead of the Street Name signs at the intersection.**

Section 2E.30 Interchange Guide Signs**Standard:**

- 01 **The signs at interchanges and on their approaches shall include Advance Guide signs and Exit Direction signs. Consistent destination messages shall be displayed on these signs.**

Guidance:

- 02 *New destination information should not be introduced into the major sign sequence for one interchange, nor should destination information be dropped.*
- 03 *Reference should be made to Section 2E.11 and Sections 2E.33 through 2E.42 for a detailed description of the signs in the order that they should appear at the approach to and beyond each interchange. Guide signs placed in advance of an interchange deceleration lane should be spaced at least 800 feet apart.*
- 04 *Supplemental guide signing should be used sparingly as provided in Section 2E.35.*

Section 2E.31 Interchange Exit Numbering (E1-H5P)

Support:

- 01 Interchange exit numbering provides valuable orientation for the road user on a freeway or expressway. The feasibility of numbering interchanges or exits on an expressway will depend largely on the extent to which grade separations are provided. Where there is appreciable continuity of interchange facilities, interrupted only by an occasional intersection at grade, the numbering will be helpful to the expressway user.

Standard:

- 02 **Interchange numbering shall be used in signing each freeway interchange exit. Interchange exit numbers shall be displayed with each Advance Guide sign, Exit Direction sign, and Exit Gore sign. The exit number shall be displayed on a separate plaque at the top of the Advance Guide or Exit Direction sign. The exit number (E1-H5P) plaque (see Figure 2E-22) shall be 30 inches in height and shall include the word EXIT and the appropriate exit number in a single-line format on. Suffix letters shall be used for exit numbering at a multi-exit interchange. The suffix letter shall also be included on the exit number plaque and shall be separated from the exit number by a space having a width of between 1/2 and 3/4 of the height of the suffix letter. Exit numbers shall not include the cardinal**

Figure 2E-19. Example of Interchange Numbering for Mainline and Circumferential Routes

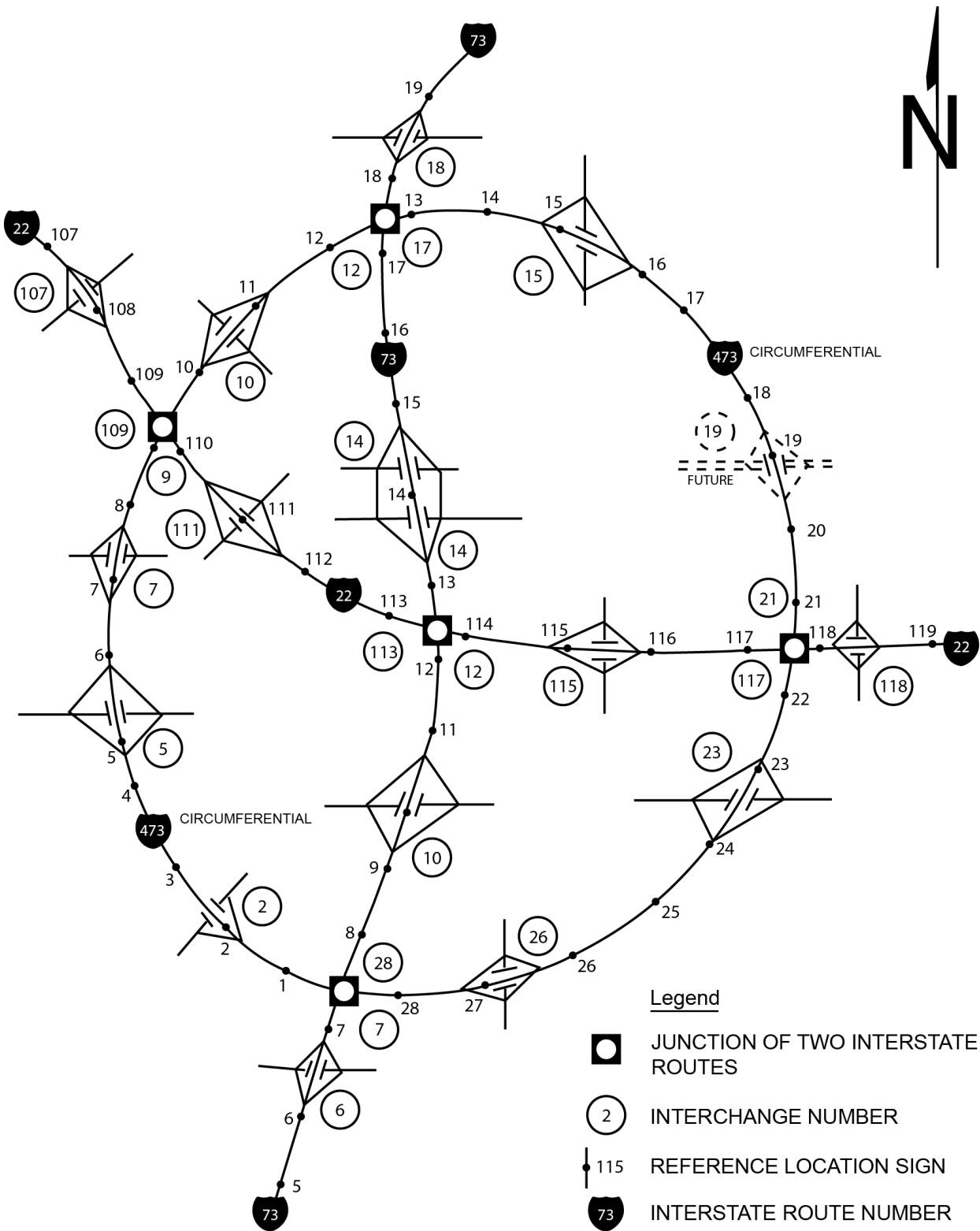
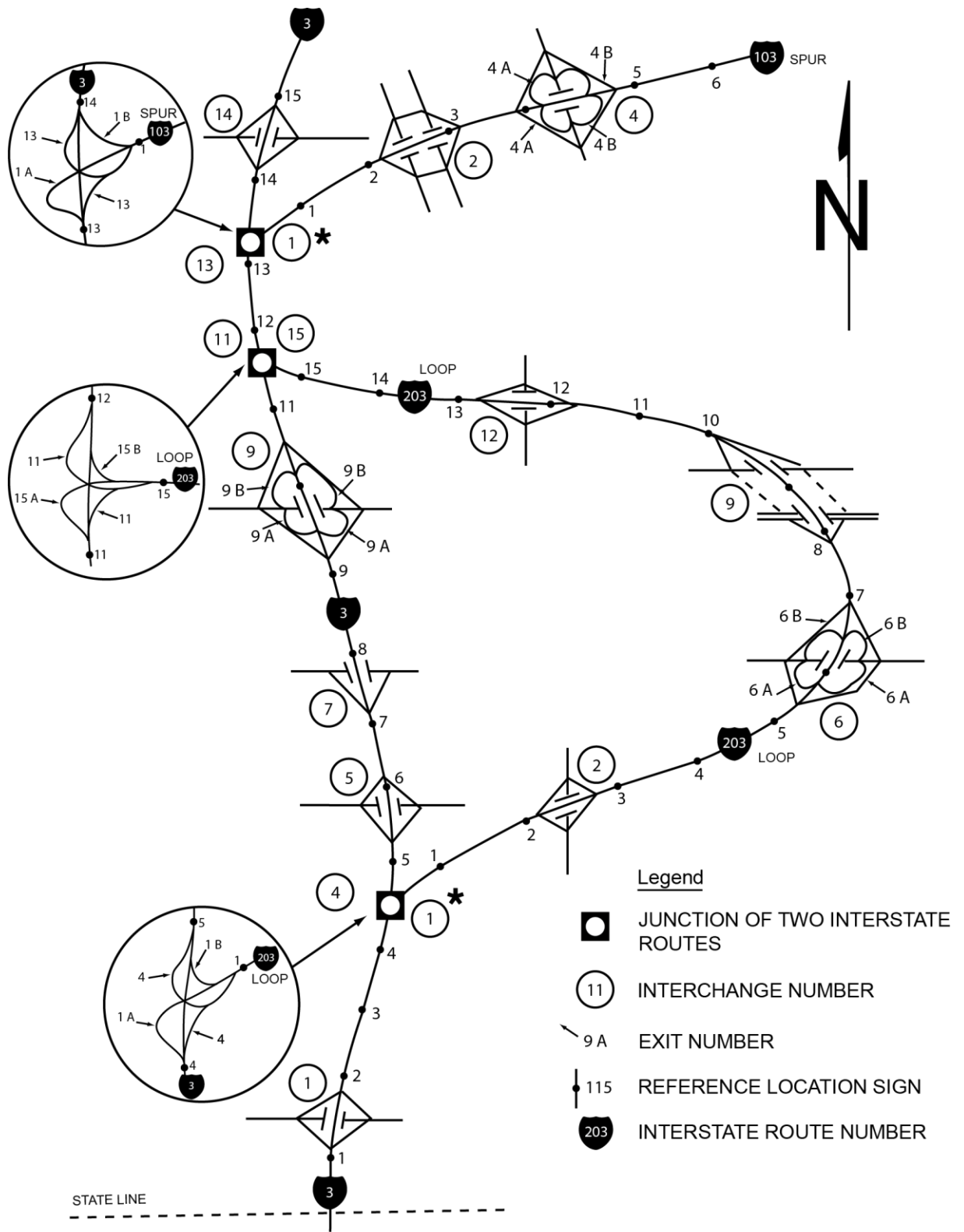
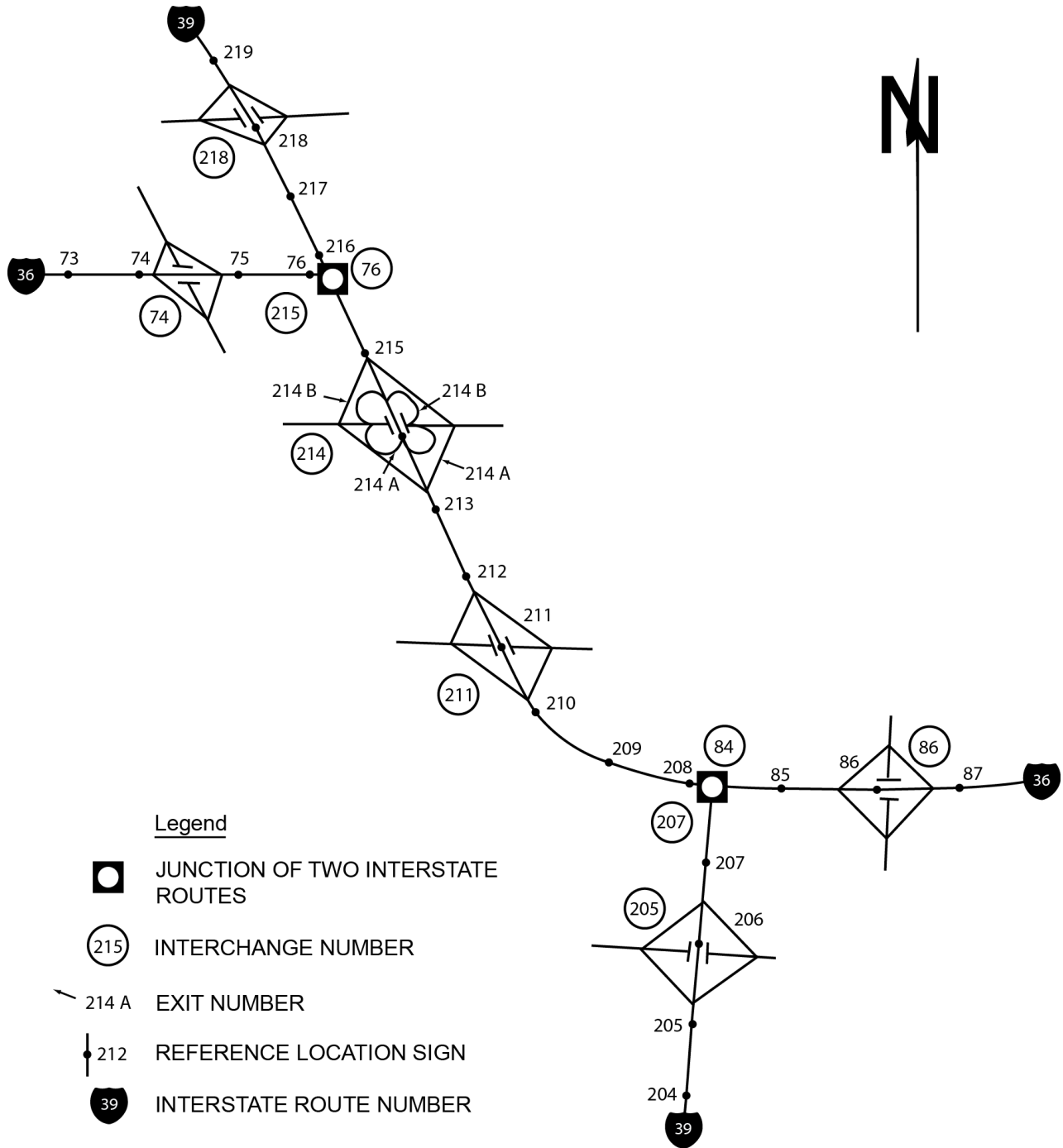

Figure 2E-20. Example of Interchange Numbering for Mainline, Loop, and Spur Routes



* The freeway/freeway interchange where the beginning of the loop or spur route intersects with the mainline route may be called either Exit 1 or Exit 0 on the loop or spur route.

Figure 2E-21. Example of Interchange Numbering for Overlapping Routes



initials corresponding to the directions of the cross route. The design for the E1-H5P is provided in the SDMM. If used, the interchange numbering system for expressways shall comply with the provisions prescribed for freeways.

03 **At a multi-exit interchange where suffix letters are used for exit numbering, an exit of the same number without a suffix letter shall not be used on the same route in the same direction. For example, if an exit is designated as EXIT 256 A, then there shall not be an exit designated as EXIT 256 on the same route in the same direction.**

04 **Interchange exit numbering shall use the reference location sign exit numbering method. The consecutive exit numbering method shall not be used.**

Support:

05 Reference location sign exit numbering assists road users in determining their destination distances and travel mileage, and assists highway agencies because the exit numbering sequence does not have to be changed if new interchanges are added to a route.

Option:

06 Exit numbers may also be used with Supplemental Guide signs and Motorist Service signs.

Guidance:

07 *Exit number (E1-H5P) plaques should be added to the top right-hand edge of the sign for an exit to the right.*

Standard:

08 **Because road users might not expect an exit to the left and might have difficulty in maneuvering to the left, a left exit number (E1-H5bP) plaque (see Figure 2E-22) shall be added to the top left-hand edge of the sign for all left-hand exits (see Figures 2E-14 and 2E-15). The word LEFT on the E1-H5bP plaque shall be a black legend on a yellow rectangular sign panel and shall be centered above the word EXIT.**

Support:

09 Example exit number plaque designs are shown in Figure 2E-22. Figures 2E-3, 2E-7, 2E-22, 2E-26 and 2E-27 illustrate the incorporation of exit number plaques on guide signs.

10 The general plan for numbering interchange exits is shown in Figures 2E-19 through 2E-21. Figure 2E-19 shows a circumferential route, which is a route that makes a complete circle around a city or town and usually has two interchanges (one on each side of the city or town) with each of the mainline routes that travel through the city or town. Figure 2E-20 shows a loop route, which is a route that departs from a mainline route and then rejoins the same mainline route at a subsequent point downstream, and a spur route, which is a route that departs from a mainline route and never rejoins the same mainline route. Figure 2E-21 shows two mainline routes that overlap each other.

Standard:

11 **Regardless of whether a mainline route originates within Ohio or crosses into the State from another State, the southernmost or westernmost terminus within the State shall be the beginning point for interchange numbering.**

12 **For circumferential routes, interchange numbering shall be in a clockwise direction. The numbering shall begin with the first interchange west of the south end of an imaginary north-south line bisecting the circumferential route, at a radial freeway or other Interstate route, or some other conspicuous landmark in the circumferential route near a south polar location (see Figure 2E-19).**

13 **The interchange numbers on loop routes shall begin at the loop interchange nearest the south or west mainline junction and increase in magnitude toward the north or east mainline junction (see Figure 2E-20).**

14 **Spur route interchanges shall be numbered in ascending order starting at the interchange where the spur leaves the mainline (see Figure 2E-20).**

15 **If a circumferential, loop, or spur route crosses State boundaries, the numbering sequence shall be coordinated by the States to provide continuous interchange numbering.**

16 **Where numbered routes overlap, continuity of interchange numbering shall be established for only one of the routes (see Figure 2E-21). If one of the routes is an Interstate and the other route is not an Interstate, the Interstate route shall maintain continuity of interchange numbering.**

Guidance:

17 *The route chosen for continuity of interchange numbering should also have reference location sign continuity (see Figure 2E-21).*

Section 2E.32 Interchange Classification

Support:

01 For signing purposes, interchanges are classified as major, intermediate, and minor. The minimum alphabet sizes contained in Table 2E-3 are based on this classification. Descriptions of these classifications are as follows:

- A. Major interchanges are subdivided into two categories: (a) interchanges with other expressways or freeways, or (b) interchanges with high-volume multi-lane highways, principal urban arterials, or major rural routes where the volume of interchanging traffic is heavy or includes many road users unfamiliar with the area.
- B. Intermediate interchanges are those with urban and rural routes not in the category of major or minor interchanges.
- C. Minor interchanges include those where traffic is local and very light, such as interchanges with land service access roads. Where the sum of exit volumes is estimated to be lower than 100 vehicles per day in the design year, the interchange is classified as minor.

Section 2E.33 Advance Guide Signs

Support:

01 An Advance Guide sign (see Figure 2E-22) gives notice well in advance of the exit point of the principal destinations served by the next interchange and the distance to that interchange.

Guidance:

02 *For major and intermediate interchanges (see Section 2E.32), Advance Guide signs should be placed at 1/2 mile and at 1 mile in advance of the exit with a third Advance Guide sign placed at 2 miles in advance of the exit if spacing permits and engineering judgment indicates that there is an operational need. At minor interchanges, only one Advance Guide sign should be used. If the sign is located less than 1/2 mile from the exit, the distance displayed should be to the nearest 1/4 mile. Fractions of a mile, rather than decimals, should be displayed in all cases.*

Standard:

03 **For numbered exits to the left, a left exit number (E1-H5bP) plaque (see Figure 2E-22) shall be added to the top left-hand edge of the sign.**

04 **For non-numbered exits to the left, a LEFT (E1-5aP) plaque (see Figure 2E-22) shall be added to the top left-hand edge of the sign.**

Support:

05 Section 2E.31 contains additional information regarding exit numbering.

Standard:

06 **Advance Guide signs for multi-lane exits having an optional exit lane that also carries the through route (see Figures 2E-4, 2E-5, 2E-8, and 2E-9) and for splits with an option lane (see Figures 2E-6 and 2E-10) shall be Overhead Arrow-per-Lane or diagrammatic signs designed in accordance with Sections 2E.20 through 2E.22.**

07 **Except as provided in Section 2E.24, Advance Guide signs, if used, shall contain the distance message. Except as provided in Paragraph 8 of this Section, the legend on the Advance Guide signs shall be the same as the legend on the Exit Direction sign, except that the last line shall read EXIT XX MILES. If the interchange has two or more exit roadways, the bottom line shall read EXITS XX MILES.**

Figure 2E-22. Examples of Interchange Advance Guide Signs, Exit Number Plaques, and LEFT Plaque

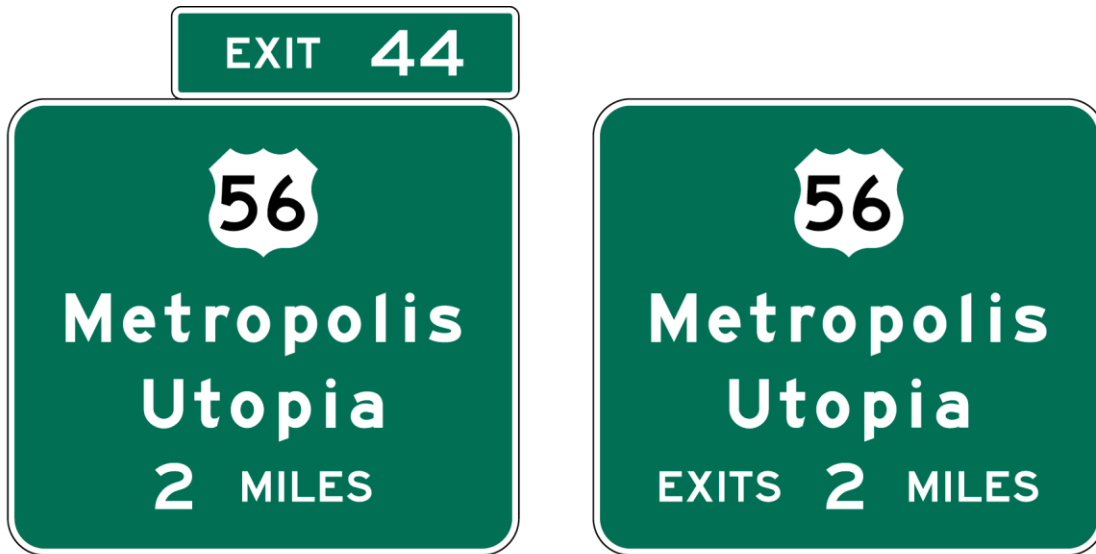

Note: Delete word EXIT(S) if exit number is used.



E1-H5P



E1-5aP



E1-H5bP

Guidance:

08 Where interchange exit numbers are used, the word EXIT(S) should be omitted from the bottom line.

Option:

09 Where the distance between interchanges is more than 1 mile, but less than 2 miles, the first Advance Guide sign may be closer than 2 miles, but not placed so as to overlap the signing for the previous exit. Duplicate Advance Guide signs or Interchange Sequence Series signs may be placed in the median on the opposite side of the roadway and are not included in the minimum requirements of interchange signing.

Figure 2E-23. Next Exit Plaques**Guidance:**

10 Where there is less than 800 feet between interchanges, Interchange Sequence Series signs (see Section 2E.40) should be used instead of Advance Guide signs for the affected interchanges.

11 The Advance Guide signs for the last exit from a highway before it becomes a facility on which toll payments are required should include the LAST EXIT BEFORE TOLL (W16-16P) plaque (see Section 2F.10 and Figure 2F-3). The plaque should be installed above the Advance Guide signs.

Option:

12 If there is insufficient space above the Advance Guide sign because of the presence of an exit number plaque, the W16-16P plaque may be installed below the Advance Guide sign.

Section 2E.34 Next Exit Plaques (E2-H1P, E2-H1aP)**Option:**

01 Where the distance to the next interchange is unusually long, a Next Exit (E2-H1P, E2-H1aP) plaque (see Figure 2E-23) may be installed to inform road users of the distance to the next interchange.

Guidance:

02 The Next Exit plaque should not be used unless the distance between successive interchanges is more than 5 miles.

Standard:

03 The Next Exit plaque shall carry the legend NEXT EXIT XX MILES. If the Next Exit plaque is used, it shall be placed below the Advance Guide sign nearest the interchange. It shall be mounted so as to not adversely affect the breakaway feature of the sign support structure.

Option:

04 The legend for the Next Exit plaque may be displayed in either one or two lines as shown in Figure 2E-23.

Support:

05 The one-line message on the Next Exit plaque is the more desirable choice unless the message causes the sign to have a horizontal dimension greater than that of the Advance Guide sign.

Section 2E.35 Other Supplemental Guide Signs**Support:**

01 Supplemental Guide signs can be used to provide information regarding destinations accessible from an interchange, other than places displayed on the standard interchange signing. However, such Supplemental Guide signing can reduce the effectiveness of other more important guide signing because of the possibility of overloading the road user's capacity to receive visual messages and make appropriate decisions. "The AASHTO Guidelines for the Selection of Supplemental Guide Signs for Traffic Generators Adjacent to Freeways" (see the Preface for AASHTO's address) and Part 2 of ODOT's "Traffic Engineering Manual" (see Section 1A.11) address guidelines used to identify destinations that qualify as traffic generators for which guide signs may be erected on freeways and expressways.

Guidance:

02 *No more than one Supplemental Guide sign should be used on each interchange approach.*

03 *A Supplemental Guide sign (see Figure 2E-24) should not list more than two destinations. Destination names should be followed by the interchange number (and suffix), or if interchanges are not numbered, by the legend NEXT RIGHT or SECOND RIGHT or both, as appropriate. The Supplemental Guide sign should be installed as an independent guide sign assembly.*

04 *Where two or more Advance Guide signs are used, the Supplemental Guide sign should be installed approximately midway between two of the Advance Guide signs. If only one Advance Guide sign is used, the Supplemental Guide sign should follow it by at least 800 feet. If the interchanges are numbered, the interchange number should be used for the action message.*

05 *To control proliferation of these signs and to aid in uniformity, each highway agency should develop an appropriate policy similar to ODOT's for installing supplemental signs (see Part 2 of ODOT's "Traffic Engineering Manual"). In developing policies for such signing, such items as population, amount of traffic generated, distance from the route, and the significance of the destination should be taken into account.*

Standard:

06 **Guide signs directing drivers to park-ride facilities (D4-H2a, D4-H2b) shall be considered as Supplemental Guide signs (see Figure 2E-25).**

Option:

07 *A pictograph (see definition in Section 1A.13) may be used on a Supplemental Guide sign in conjunction with a destination that is associated with governmental agencies, military bases, universities, or other government-approved institutions.*

Standard:

08 **The maximum dimension (height or width) of a pictograph shall not exceed two times the upper-case letter height of the destination legend and shall not exceed the size of a route shield on the guide sign. If used, the pictograph shall be located to the left of the destination legend it represents, except as provided in Paragraph 9 for the park-ride Supplemental Guide sign.**

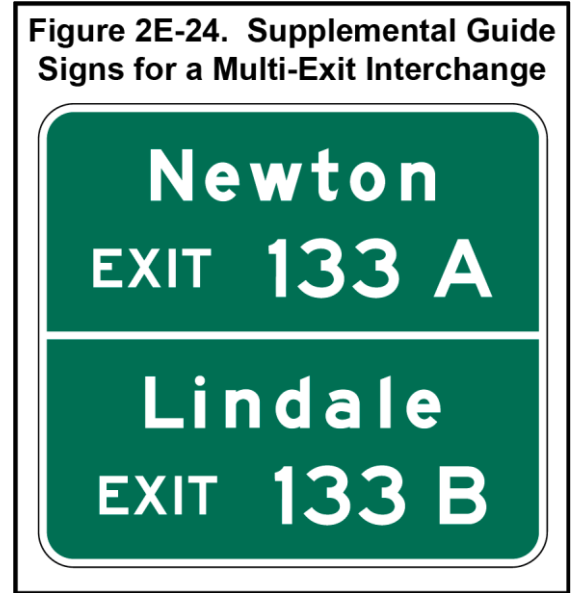

Figure 2E-25. Supplemental Guide Sign for a Park – Ride Facility

A – ROUTE WITHOUT EXIT NUMBERING



D4-H2a

B – ROUTE WITH EXIT NUMBERING

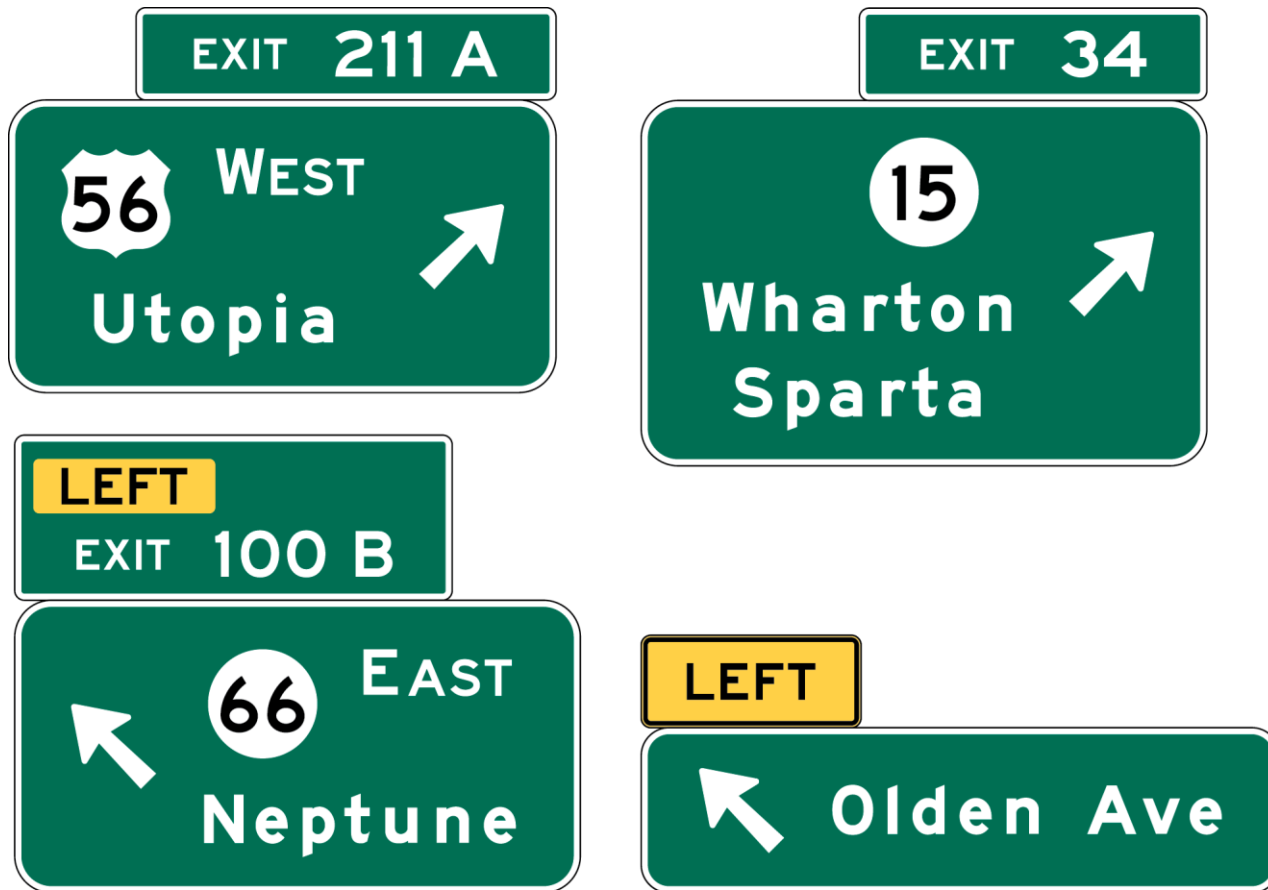

D4-H2b

Figure 2E-26. Examples of Interchange Exit Direction Signs

Note: See Figures 2D-3 and 2D-4 for the correct design of an Ohio State Route Sign.

09 When a transit pictograph is displayed on the park-ride Supplemental Guide sign, it shall be located on the same line as the carpool symbol, if used, above the word legend.

10 A pictograph representing a State, county, municipal corporation, or other incorporated or unincorporated community shall not be displayed on a Supplemental Guide sign.

11 Pictographs shall otherwise comply with the provisions of Section 2A.06.

Section 2E.36 Exit Direction Signs

Support:

01 The Exit Direction sign (see Figure 2E-26) repeats the route and destination information that was displayed on the Advance Guide sign(s) for the next exit, and thereby assures road users of the destination served and indicates whether they exit to the right or left for that destination.

Standard:

02 **Exit Direction signs shall be used at major and intermediate interchanges. Populations or other similar information shall not be displayed on Exit Direction signs.**

Guidance:

03 *Exit Direction signs should be used at minor interchanges.*

04 *Post-mounted Exit Direction signs should be installed at the beginning of the deceleration lane. If there is less than 300 feet from the upstream end of the deceleration lane to the theoretical gore (see Figure 3B-8), the Exit Direction sign should be installed overhead over the exiting lane in the vicinity of the theoretical gore.*

Standard:

- 05 Except where Overhead Arrow-per-Lane guide signs are used (see Section 2E.21 and Paragraph 6 of this Section), where a through lane is being terminated (dropped) at an exit, the Exit Direction sign shall be placed overhead at the theoretical gore (see Figures 2E-8 and 2E-11, and 2E-14 through 2E-16).
- 06 Except as provided in Paragraph 4 in Section 2E.21, where Overhead Arrow-per-Lane guide signs are used for the Advance Guide sign(s) for a multi-lane exit having an optional exit lane that also carries the through route or for a split with an option lane (see Section 2E.21), an Overhead Arrow-per-Lane guide sign shall also be used instead of the Exit Direction sign. This Overhead Arrow-per-Lane guide sign shall include the appropriate exit number (E1-H5P or E1-H5bP) plaque (if a numbered exit) and it shall be located near, but not downstream from, the point where the outside edge of the dropped lane begins to diverge from the mainline (see Figures 2E-4 through 2E-6).
- 07 The following provisions shall govern the design and application of overhead Exit Direction signs:
- A. The sign shall carry the exit number (if exit numbering is used), the route number, cardinal direction, and destination, as applicable, with a diagonally upward-pointing directional arrow (see Figure 2E-26).
 - B. The message EXIT ONLY in black on a yellow sign panel (E11-1, E11-1d, E11-1e, E11-1f) shall be used on the overhead Exit Direction sign to advise road users of a lane drop situation (see Figures 2E-8 through 2E-11). The sign shall comply with the provisions of Section 2E.24.

Guidance:

- 08 For numbered exits to the right, an exit number (E1-H5P) plaque (see Figure 2E-22) should be added to the top right-hand edge of the sign.

Standard:

- 09 For numbered exits to the left, a left exit number (E1-H5bP) plaque (see Figure 2E-22) shall be added to the top left-hand edge of the sign.
- 10 For non-numbered exits to the left, a LEFT (E1-5aP) plaque (see Figure 2E-22) shall be added to the top left-hand edge of the sign.

Support:

- 11 Section 2E.31 contains additional information regarding exit numbering.

Option:

- 12 In some cases, principally in urban areas, where restricted sight distance because of structures or unusual alignment make it impossible to locate the Exit Direction sign without violating the required minimum spacing (see Section 2E.33) between major guide signs, Interchange Sequence signs (see Section 2E.40) may be substituted for an Advance Guide sign.

Guidance:

- 13 At multi-exit interchanges, the Exit Direction sign should be located directly over the exiting lane for the first exit. At the same location, and normally over the right-hand through lane, an Advance Guide sign for the second exit should be located. Only for those conditions where the through movement is not evident should a confirmatory message (Pull-Through sign as shown in Figure 2E-2) be used over the left lane(s) to guide road users traveling through an interchange. In the interest of sign spreading, three signs on one structure should not be used. When the freeway or expressway is on an overpass, the Exit Direction sign should be installed on an overhead support over the exit lane in advance of the gore point.

Option:

- 14 If the second exit is beyond an underpass, the Exit Direction sign may be mounted on the face of the overhead structure.
- 15 Where extra emphasis of an especially low advisory ramp speed is needed, an EXIT XX MPH (E13-2) sign panel (see Figure 2E-27) may be placed at the bottom of the Exit Direction sign to supplement, but not to replace, the exit or ramp advisory speed warning signs.

Figure 2E-27. Interchange Exit Direction Sign with an Advisory Speed Panel

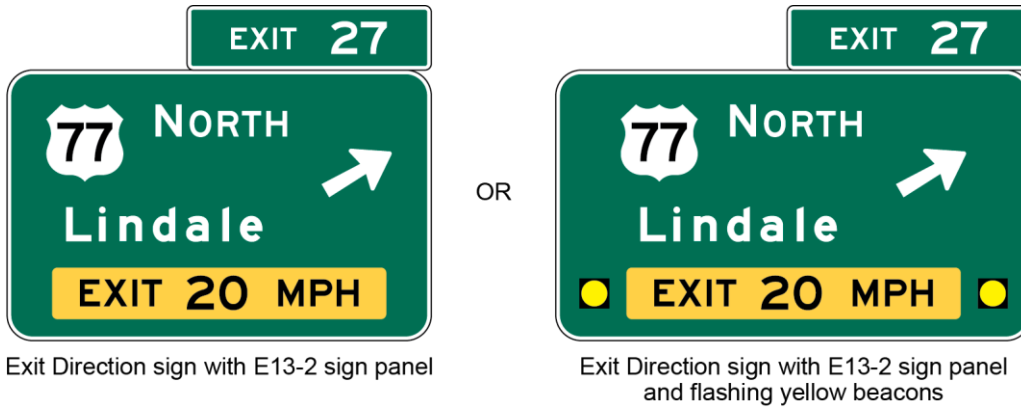

Exit Direction sign with E13-2 sign panel

Exit Direction sign with E13-2 sign panel and flashing yellow beacons

Guidance:

16 At the last exit from a highway before it becomes a facility on which toll payments are required, the **LAST EXIT BEFORE TOLL (W16-16P)** plaque (see Section 2F.10 and Figure 2F-3) should be installed above the Exit Direction sign.

Option:

17 If there is insufficient space above the Exit Direction sign because of the presence of an Exit Number (E1-H5P) plaque, the W16-16P plaque may be mounted below the Exit Direction sign.

Section 2E.37 Exit Gore Signs (E5-H1 Series)

Support:

01 The Exit Gore (E5-H1 series) sign in the gore indicates the exiting point or the place of departure from the main roadway. Consistent application of this sign at each exit is important.

Standard:

02 **The gore shall be defined as the area located between the main roadway and the ramp just beyond where the ramp branches from the main roadway. The Exit Gore sign shall be located in the gore and shall carry the word EXIT or EXIT XX (if interchange numbering is used) and an appropriate upward slanting arrow. If suffix letters are used for exit numbering at a multi-exit interchange, the suffix letter shall also be included on the Exit Gore sign and shall be separated from the exit number by a space having a width of between 1/2 and 3/4 of the height of the suffix letter. Breakaway or yielding supports shall be used.**

Guidance:

03 The arrow should be aligned to approximate the angle of departure. Each gore should be treated similarly, whether the interchange has one exit roadway or multiple exits.

Option:

04 Where extra emphasis of an especially low advisory ramp speed is needed, an E13-1P plaque indicating the advisory speed may be mounted below the Exit Gore sign (see Figure 2E-28) to supplement, but not to replace, the exit or ramp advisory speed warning signs.

05 To improve the visibility of the gore for exiting drivers, a Type 1 object marker (see Chapter 2C) may be installed on each sign support below the Exit Gore sign.



06 An Exit Number (E5-H1bP) plaque (see Figure 2E-28) may be installed above an existing Exit Gore (E5-H1) sign when a non-numbered exit is converted to a numbered exit.

Standard:

07 **An Exit Gore (E5-H1a) sign shall be used when the replacement of an existing assembly of an E5-H1 sign and an E5-1bP plaque becomes necessary.**

Option:

08 The Narrow Exit Gore (E5-H1c) sign may be used in gore areas of limited width where the width of the Exit Gore (E5-H1a) sign would not permit sufficient lateral offset (see Section 2A.19), such as for ramp departures that are nearly parallel to the mainline roadway where the Exit Gore sign would be mounted on a narrow island or barrier. Where the E5-H1c sign is mounted at a height of 14 feet or more from the roadway, the directional arrow may point diagonally downward.

Guidance:

09 *Except as noted in Paragraph 10, the E5-H1c should not be used in gore areas where an E5-H1a sign could be installed with sufficient lateral offset.*

Option:

10 *The Narrow Exit Gore (E5-H1c) sign may be used where engineering judgment predicts a high occurrence of gore sign impacts.*

Section 2E.38 Post-Interchange Signs

Guidance:

01 *If space between interchanges permits, as in rural areas, and where undue repetition of messages will not occur, a fixed sequence of signs should be displayed beginning 500 feet beyond the downstream end of the acceleration lane. At this point a Route sign assembly should be installed followed by a Speed Limit sign and a Distance sign, each at a spacing of 1,000 feet.*

02 *If space between interchanges does not permit placement of these three post-interchange signs without encroaching on or overlapping the Advance Guide signs necessary for the next interchange, or in rural areas where the interchanging traffic is primarily local, one or more of the post-interchange signs should be omitted.*

Option:

03 Usually the Distance sign will be of less importance than the other two signs and may be omitted, especially if Interchange Sequence signs are used. If the sign for through traffic on an overhead assembly already contains the route sign, the post-interchange route sign assembly may also be omitted.

Section 2E.39 Post-Interchange Distance Signs (E7-H1)

Standard:

01 **If used, the Post-Interchange Distance (E7-H1) sign shall consist of a two- or three-line sign carrying the names of significant destination points and the distances to those points. The top line of the sign shall identify the next meaningful interchange with the name of the community near or through which the route passes, or if there is no community, the route number or name of the intersected highway (see Figure 2E-29).**

Support:

02 The minimum sizes of the route shields identifying a significant destination point are prescribed in Tables 2E-3.

Option:

03 The text identification of a route may be displayed instead of a route shield, such as "US XX," "State Route XX," or "County Route XX."

Guidance:

04 *If a second line is used, it should be reserved for communities of general interest that are located on or immediately adjacent to the route or for major traffic generators along the route.*

05 The choice of names for the second line, if it is used, may be varied on successive Distance signs to give road users maximum information concerning communities served by the route.

Standard:

06 **The third, or bottom line, shall contain the name and distance to a control city (if any) that has national significance for travelers using the route.**

Guidance:

07 *Distances to the same destinations should not be shown more frequently than at 5-mile intervals. The distances displayed on these signs should be the actual distance to the destination points and not to the exit from the freeway or expressway. The distance displayed for each community should comply with the provisions of Section 2D.41.*

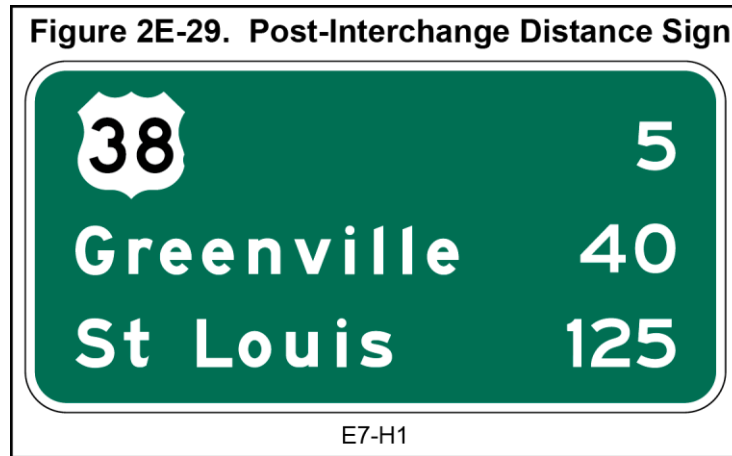

Section 2E.40 Interchange Sequence Signs (E7-H2)

Option:

01 If interchanges are closely spaced, particularly through large urban areas, so that guide signs cannot be adequately spaced, Interchange Sequence signs identifying the next two or three interchanges may be used.

Guidance:

02 *If used, Interchange Sequence signs should be used over the entire length of a route in an urban area. Except as provided in Paragraph 3, they should not be used on a single interchange basis.*

03 *If there is less than 800 feet between interchanges, Interchange Sequence (E7-H2) signs should be used instead of the Advance Guide signs for the affected interchanges.*

Support:

04 Interchange Sequence signs are generally supplemental to Advance Guide signs. Signing of this type is illustrated in Figures 2E-30 and 2E-31, and is compatible with the sign spreading concept described in Paragraph 3 of Section 2E.11.

05 These signs are installed in a series and display the next two or three interchanges by name or route number with distances to the nearest 1/4 mile.

Standard:

06 **If used, the first sign in the series shall be located in advance of the first Advance Guide sign for the first interchange.**

07 **Where the exit direction is to the left, a LEFT (E11-2) sign panel (see Figure 2E-13) shall be displayed on the same line immediately to the right of the interchange name or route number.**

08 **Interchange Sequence signs shall not be substituted for Exit Direction signs.**

Guidance:

09 *Interchange Sequence signs should be located in the median. After the first of the series, Interchange Sequence signs should be placed approximately midway between interchanges.*

Standard:

10 **Interchange Sequence signs located in the median shall be installed at overhead sign height (see Section 2A.18).**

Figure 2E-30. Example of Using an Interchange Sequence Sign for Closely-Spaced Interchanges

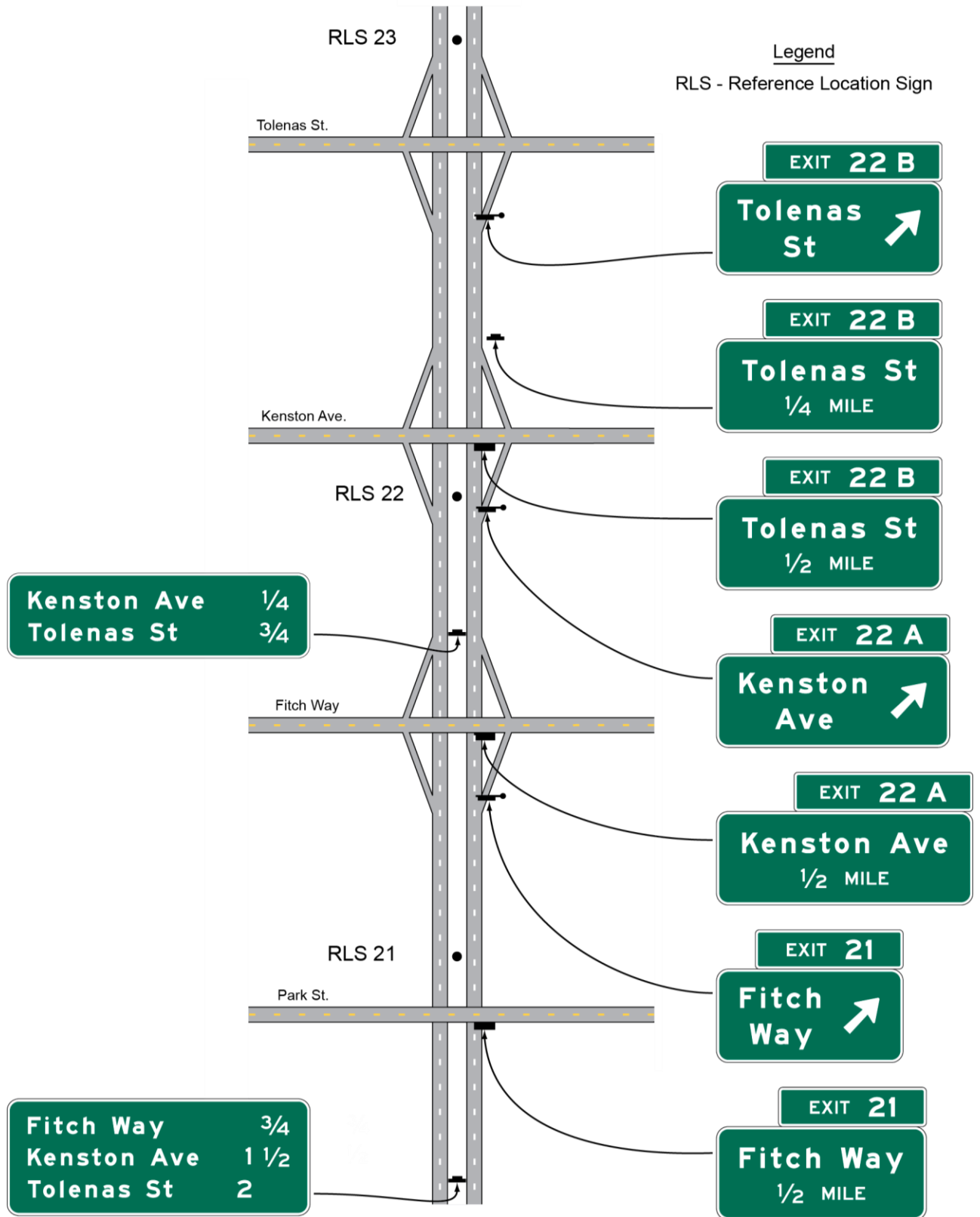

11 Interchange numbers may be displayed to the left of the interchange name or route number.

Section 2E.41 Community Interchanges Identification Signs (E7-H3)

Support:

01 For suburban or rural communities served by two or three interchanges, Community Interchanges Identification (E7-H3) signs are useful (see Figure 2E-32).

Guidance:

02 *In these cases, the name of the community followed by the word EXITS should be displayed on the top line; the lines below should display the destination, road name or route number, and the corresponding distances to the nearest 1/4 mile.*

03 *The sign should be located in advance of the first Advance Guide sign for the first interchange within the community.*

Option:

04 If interchanges are not conveniently identifiable or if there are more than three interchanges to be identified, the NEXT XX EXITS sign (see Section 2E.42) may be used.

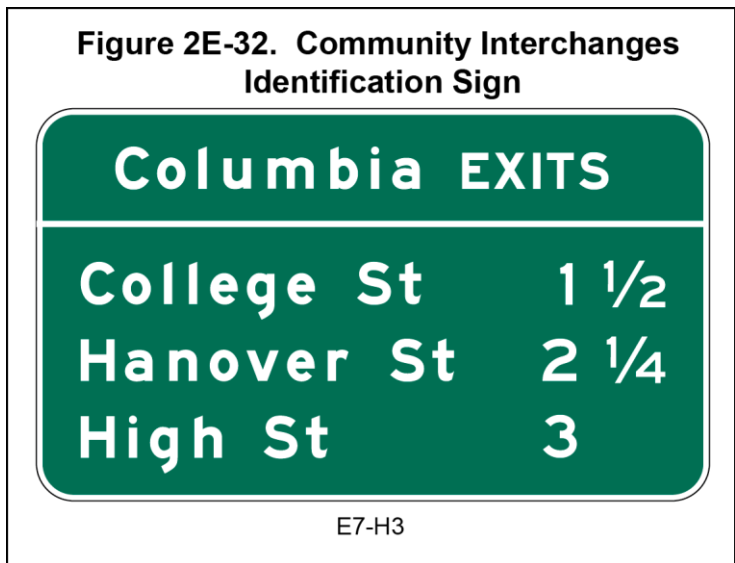
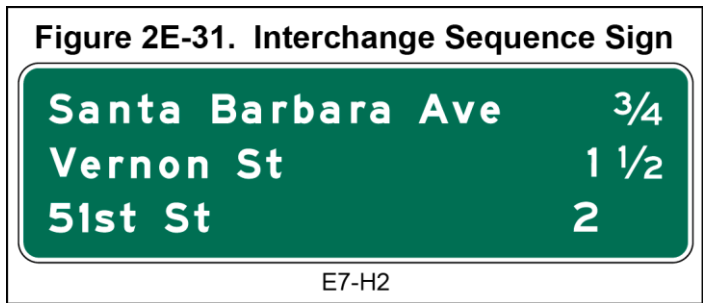

Section 2E.42 NEXT XX EXITS Sign (E7-H4)

Support:

01 Many freeways or expressways pass through historical or recreational regions, or urban areas served by a succession of several interchanges.

Option:

02 Such regions or areas may be indicated by a NEXT XX EXITS (E7-H4) sign (see Figure 2E-33) located in advance of the Advance Guide sign or signs for the first interchange.

Guidance:

03 *The sign legend should identify the region or area followed by the words NEXT XX EXITS.*

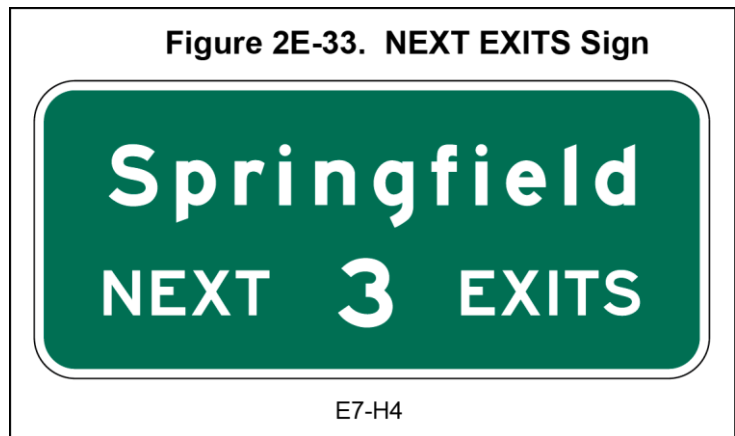

Section 2E.43 Signing by Type of Interchange

Support:

01 Road users need signs to help identify the location of the exit, as well as to obtain route, direction, and destination information for specific exit ramps. Figures 2E-34 through 2E-40 show examples of guide signs for common types of interchanges. The interchange layouts shown in most of the figures illustrate only the

major guide signs for one direction of traffic on the freeway and on the exit ramps. Section 2D.45 contains information regarding the signing of the crossroad approaches and connecting roadways to freeway and expressways.

Standard:

- 02 **Interchange guide signing shall be consistent for each type of interchange along a route.**

Guidance:

- 03 *The signing layout for all interchanges having only one exit ramp in the direction of travel should be similar, regardless of the interchange type. For the sake of uniform application, the significant features of the signing plan for each of the more frequent kinds of interchanges (illustrated in Figures 2E-34 through 2E-40) should be followed as closely as possible. Even when unusual geometric features exist, variations in signing layout should be held to a minimum.*

Section 2E.44 Freeway-to-Freeway Interchange

Support:

- 01 Freeway-to-freeway interchanges are major decision points where the effect of taking a wrong ramp cannot be easily corrected. Reversing direction on the connecting freeway or reentering to continue on the intended course is usually not possible. Figure 2E-34 shows examples of guide signs at a freeway-to-freeway interchange.

Guidance:

- 02 *The sign messages should contain only the route shield, cardinal direction, and the name of the next control city on the route. Arrows should point as indicated in Section 2D.08, except where Overhead Arrow-per-Lane or Diagrammatic signs are used in accordance with the provisions of Sections 2E.20 through 2E.22.*

Support:

- 03 At splits where the off-route movement is to the left or where there is an optional lane split, expectancy problems usually result.

Standard:

- 04 **At splits where the off-route movement is to the left, the Left Exit Number (E1-H5bP) plaque shall be added at the top left-hand edge of the guide sign (see Section 2E.31). Overhead Arrow-per-Lane or Diagrammatic guide signs (see Sections 2E.21 and 2E.22) shall be used for freeway splits with an option lane and for multi-lane freeway-to-freeway exits having an option lane.**
- 05 **Overhead signs shall be used at a distance of 1 mile and at the theoretical gore of each connecting ramp. When Overhead Arrow-per-Lane or Diagrammatic guide signs are used, they shall comply with the provisions of Sections 2E.21 and 2E.22.**

Option:

- 06 Overhead signs may also be used at the 1/2 mile and 2-mile locations.
- 07 The arrow and/or the name of the control city may be omitted on signs that indicate the straight-ahead continuation of a route on a Pull-Through signs (see Section 2E.12).
- 08 An Advisory Exit Speed sign may be used where an engineering study shows that it is necessary to display a speed reduction message for ramp signing (see Section 2C.14).
- 09 Where extra emphasis of an especially low advisory ramp speed is needed, an EXIT XX MPH (E13-2) sign panel (see Figure 2E-27) may be placed at the bottom of the Exit Direction sign to supplement, but not to replace, the exit or ramp advisory speed warning signs.

Section 2E.45 Cloverleaf Interchange

Support:

- 01 A cloverleaf interchange has two exits for each direction of travel. The exits are closely spaced and have common Advance Guide signs. Examples of guide signs for cloverleaf interchanges are shown in Figure 2E-35.

Figure 2E-34. Examples of Guide Signs for a Freeway-to-Freeway Interchange (Sheet 1 of 2)

A - Example of Signing for a Two-Lane Exit Ramp with Two Dropped Lanes and a Bifurcation Beyond the Mainline Gore

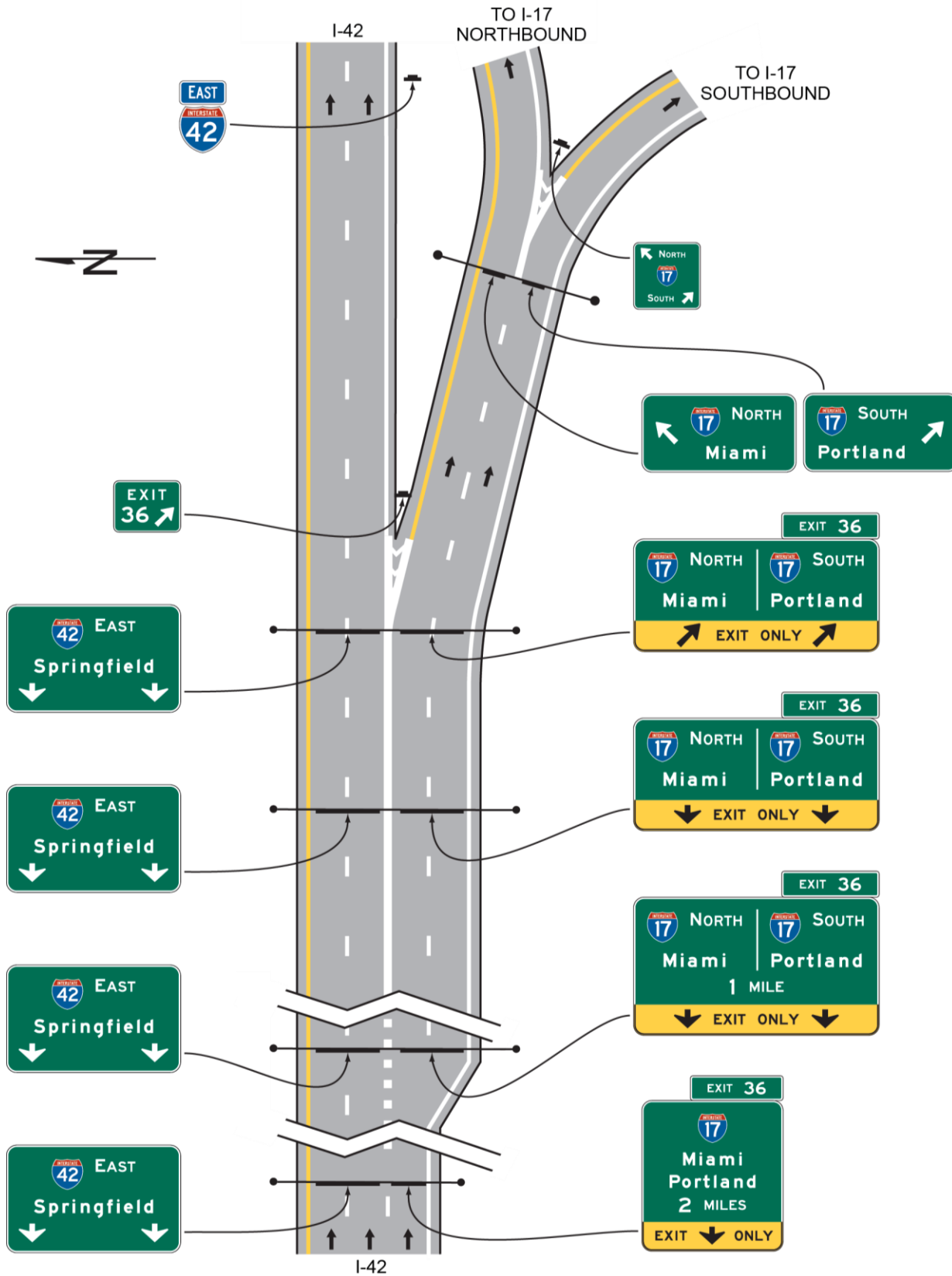

Figure 2E-34. Examples of Guide Signs for a Freeway-to-Freeway Interchange (Sheet 2 of 2)

B - Example of Signing for Successive Exit Ramps with a Dropped Lane at the Second Exit

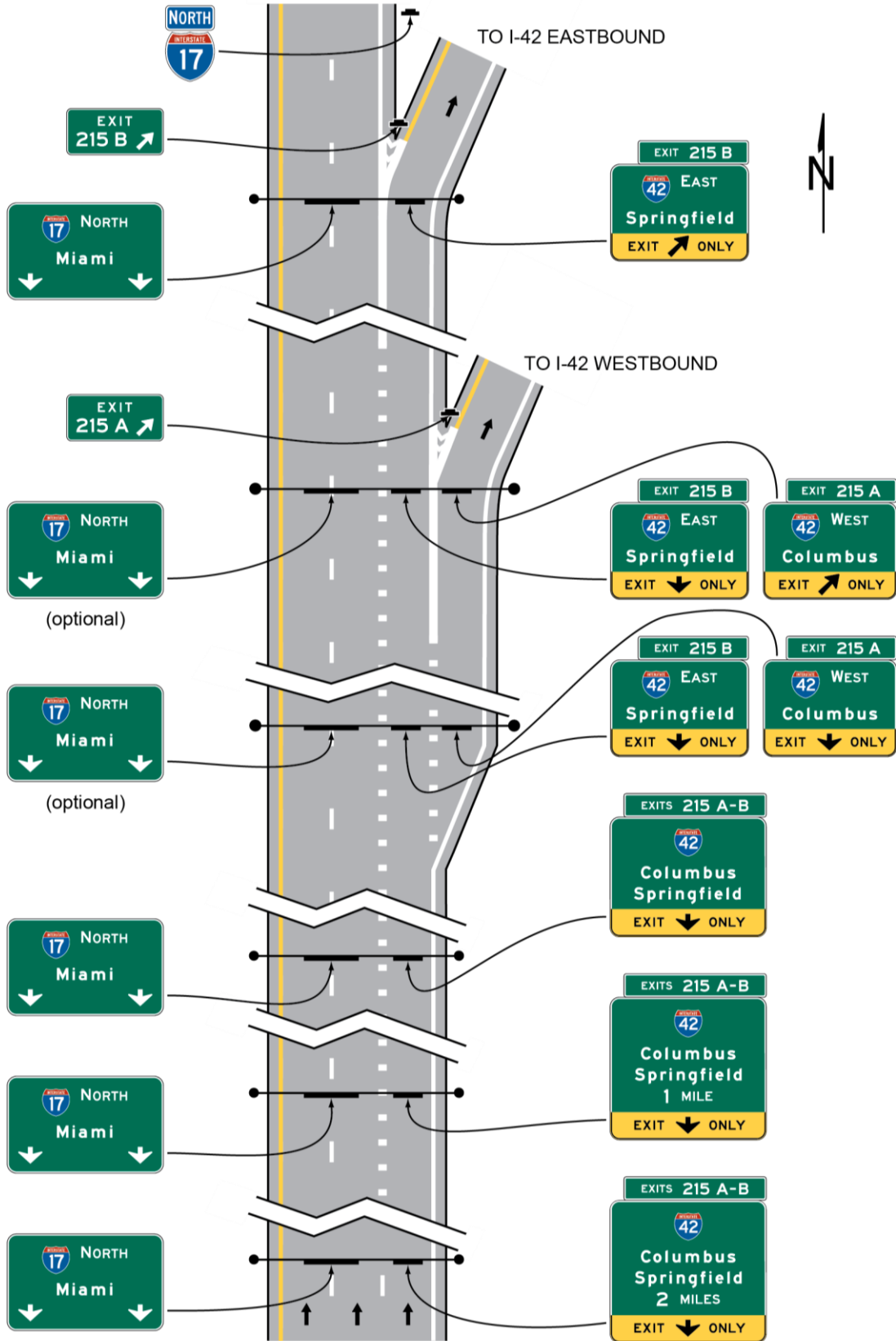

Figure 2E-35. Examples of Guide Signs for Full Cloverleaf Interchange

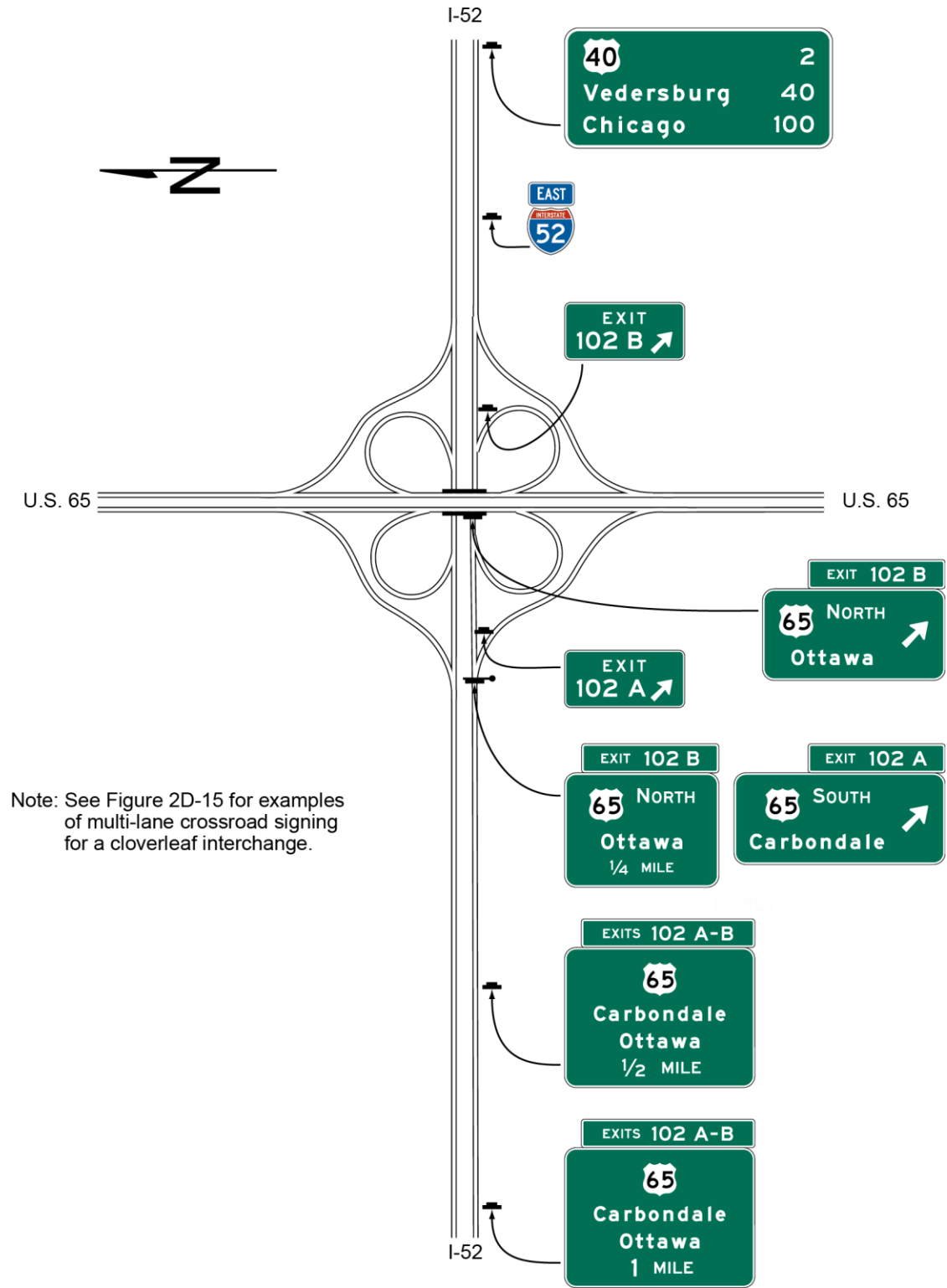

Figure 2E-36. Examples of Guide Signs for Full Cloverleaf Interchange with Collector-Distributor Roadways

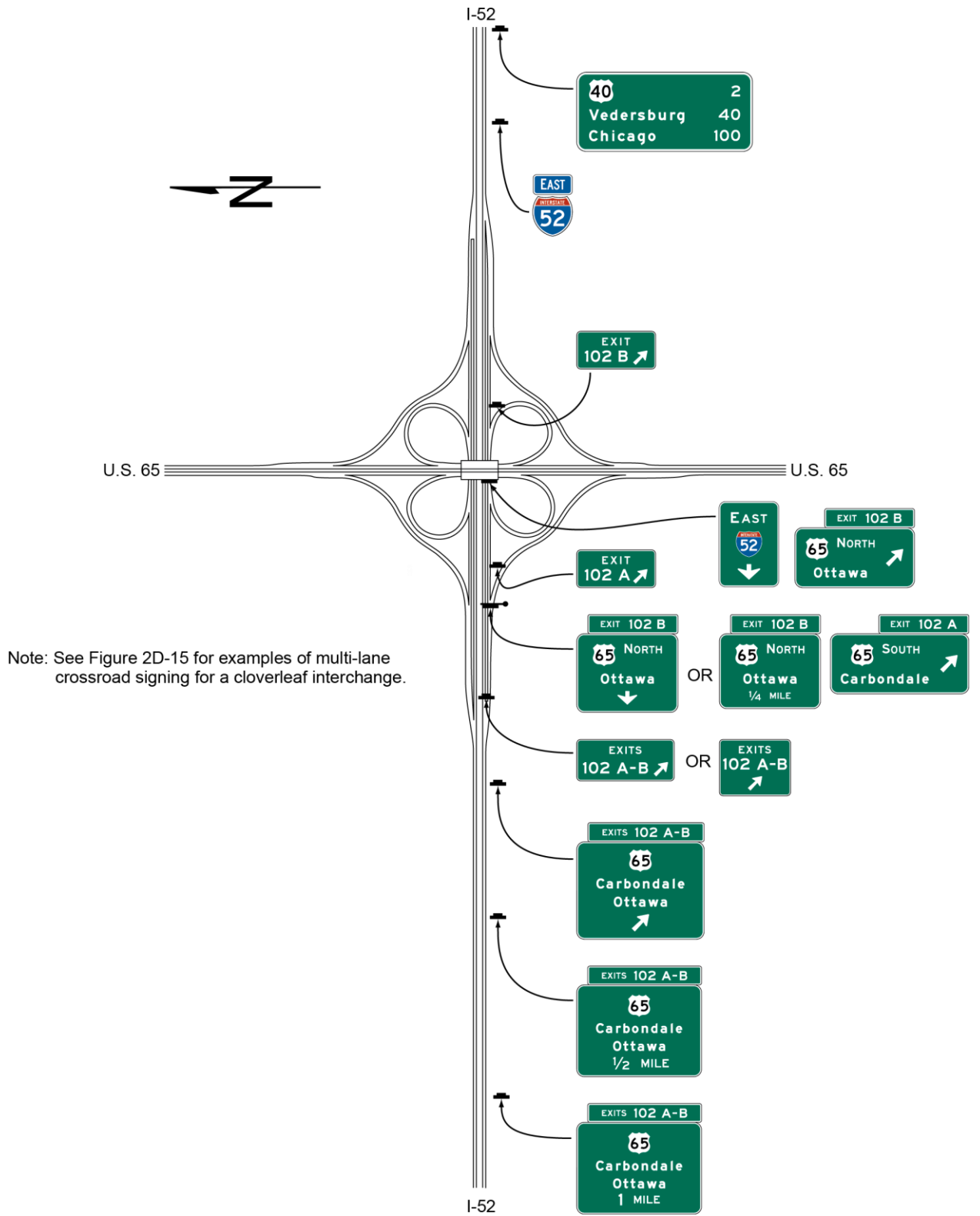
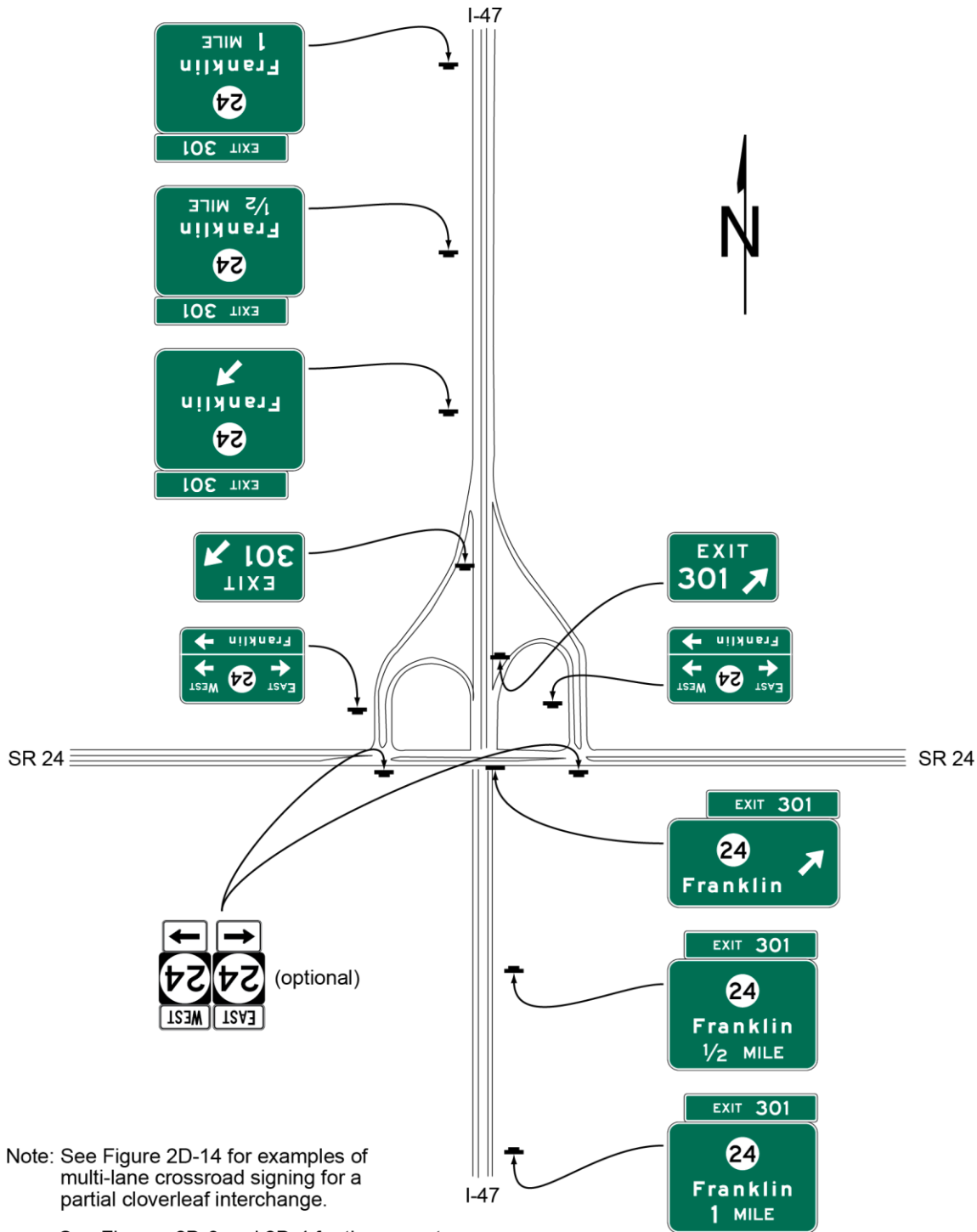

Figure 2E-37. Examples of Guide Signs for a Partial Cloverleaf Interchange



Note: See Figure 2D-14 for examples of multi-lane crossroad signing for a partial cloverleaf interchange.

See Figures 2D-3 and 2D-4 for the correct design of an Ohio State Route Sign.

- 02 *The Advance Guide signs should include two place names, one corresponding to each exit ramp, with the name of the place served by the first exit on the upper line.*

Standard:

- 03 **An overhead guide sign shall be placed at the theoretical gore of the first exit ramp, with a diagonally upward-pointing directional arrow on the Exit Direction sign for that exit and the message XX MILES, or EXIT XX MILES if interchange numbering is not used on the Advance Guide sign for the second exit, as shown in Figure 2E-35. The second exit shall be indicated by an overhead Exit Direction sign over the auxiliary lane. An Exit Gore sign shall also be used at each gore (see Section 2E.37).**

- 04 **Interchanges with more than one exit from the mainline shall be numbered as described in Section 2E.31 with an appropriate suffix.**

- 05 **Diagrammatic signs shall not be used for cloverleaf interchanges except as otherwise provided in Section 2E.22.**

Guidance:

- 06 *Where the mainline passes under the crossroad and the exit roadway is located beyond the overcrossing structure, the overhead Exit Direction sign for the second exit should be placed either on the overcrossing structure (see Figure 2E-35) or on a separate structure located immediately in front of the overcrossing structure.*

Section 2E.46 Cloverleaf Interchange with Collector-Distributor Roadways

Support:

- 01 Examples of guide signs for full cloverleaf interchanges with collector-distributor roadways are shown in Figure 2E-36.

Guidance:

- 02 *Signing on the collector-distributor roadways should be the same as the signing on the mainline of a cloverleaf interchange.*

Standard:

- 03 **Guide signs at exits from the collector-distributor roadways shall be overhead and located at the theoretical gore of the collector-distributor roadway and the exit ramp.**

Option:

- 04 Exits from the collector-distributor roadways may be numbered with an appropriate suffix. If the exits from a collector-distributor roadway are numbered with suffixes, the Advance Guide signs on the mainline may include two place names and their corresponding exit numbers with the plural EXITS. If only the exit from the mainline is numbered or if interchange numbering is not used, the Advance Guide signs on the mainline may use the singular EXIT.

Section 2E.47 Partial Cloverleaf Interchange

Support:

- 01 Examples of guide signs for partial cloverleaf interchanges are shown in Figure 2E-37.

Guidance:

- 02 *Where the mainline passes under the crossroad and the exit roadway is located beyond the overcrossing structure, the overhead Exit Direction sign should be placed either on the overcrossing structure (see Figure 2E-37) or on a separate structure located immediately in front of the overcrossing structure.*

Standard:

- 03 **A post-mounted Exit Gore sign shall also be installed in the ramp gore.**

Section 2E.48 Diamond Interchange

Support:

- 01 Examples of guide signs for diamond interchanges are shown in Figure 2E-38.

Figure 2E-38. Examples of Guide Signs for a Diamond Interchange

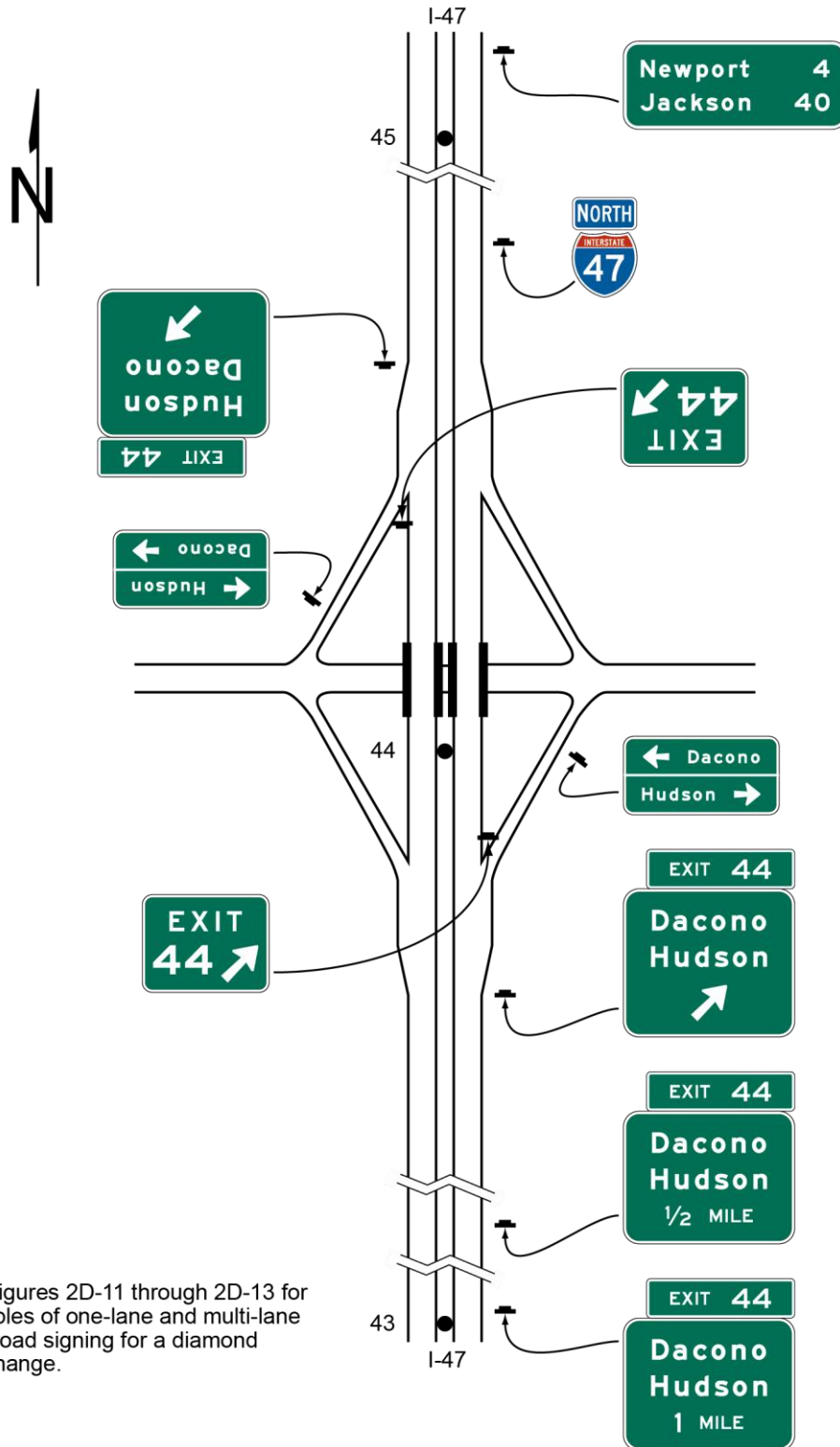

Note: See Figures 2D-11 through 2D-13 for examples of one-lane and multi-lane crossroad signing for a diamond interchange.

Standard:

- 02 **For numbered exits, the singular message EXIT shall be used on the Exit Number plaques (see Section 2E.31) with the Advance Guide and Exit Direction signs. For non-numbered exits, the singular message EXIT shall be used as part of the distance message on the Advance Guide signs.**

Support:

- 03 The typical diamond interchange ramp departs from the mainline roadway such that a speed reduction generally is not necessary in order for a driver to negotiate an exit maneuver from the mainline onto the ramp roadway.

Guidance:

- 04 *When a speed reduction is not necessary, an exit speed sign should not be used.*

Option:

- 05 An Advisory Exit Speed sign may be used where an engineering study shows that it is necessary to display a speed reduction message for ramp signing (see Section 2C.14).

Guidance:

- 06 *The Advisory Exit Speed sign should be located along the deceleration lane or along the ramp such that it is visible to the driver far enough in advance to allow the driver to decelerate before reaching the curve associated with the exiting maneuver.*

Option:

- 07 A Stop Ahead or Signal Ahead warning sign may be placed, where engineering judgment indicates a need, along the ramp in advance of the cross street, to give notice to the driver (see Section 2C.36).

Guidance:

- 08 *When used on two-lane ramps, Stop Ahead or Signal Ahead signs should be used in pairs with one sign on each side of the ramp.*

Section 2E.49 Diamond Interchange in Urban Area

Support:

- 01 Examples of guide signs for diamond interchanges in an urban area are shown in Figure 2E-39. This example includes the use of the Community Interchanges Identification sign (see Section 2E.41), which might be useful if two or more interchanges serve the same community.

- 02 In urban areas, street names are often displayed as the principal message in destination signs.

Option:

- 03 If interchanges are too closely spaced to properly locate the Advance Guide signs, they may be placed closer to the exit with the distances displayed, adjusted accordingly.

Section 2E.50 Closely Spaced Interchanges

Support:

- 01 Section 2E.11 contains information regarding sign spreading where the Exit Direction sign and the Advance Guide sign for the next interchange are mounted overhead. Sign spreading is particularly beneficial where interchanges are closely spaced and overhead signing is used in conjunction with Interchange Sequence signs as provided in Paragraph 2.

Guidance:

- 02 *Interchange Sequence signs (see Section 2E.40) should be used at closely-spaced interchanges. When used, they should identify and show street names and distances for the next two or three exits as shown in Figure 2E-30.*

Standard:

- 03 **Advance Guide signs for closely-spaced interchanges shall show information for only one interchange.**

Figure 2E-39. Examples of Guide Signs for a Diamond Interchange in an Urban Area

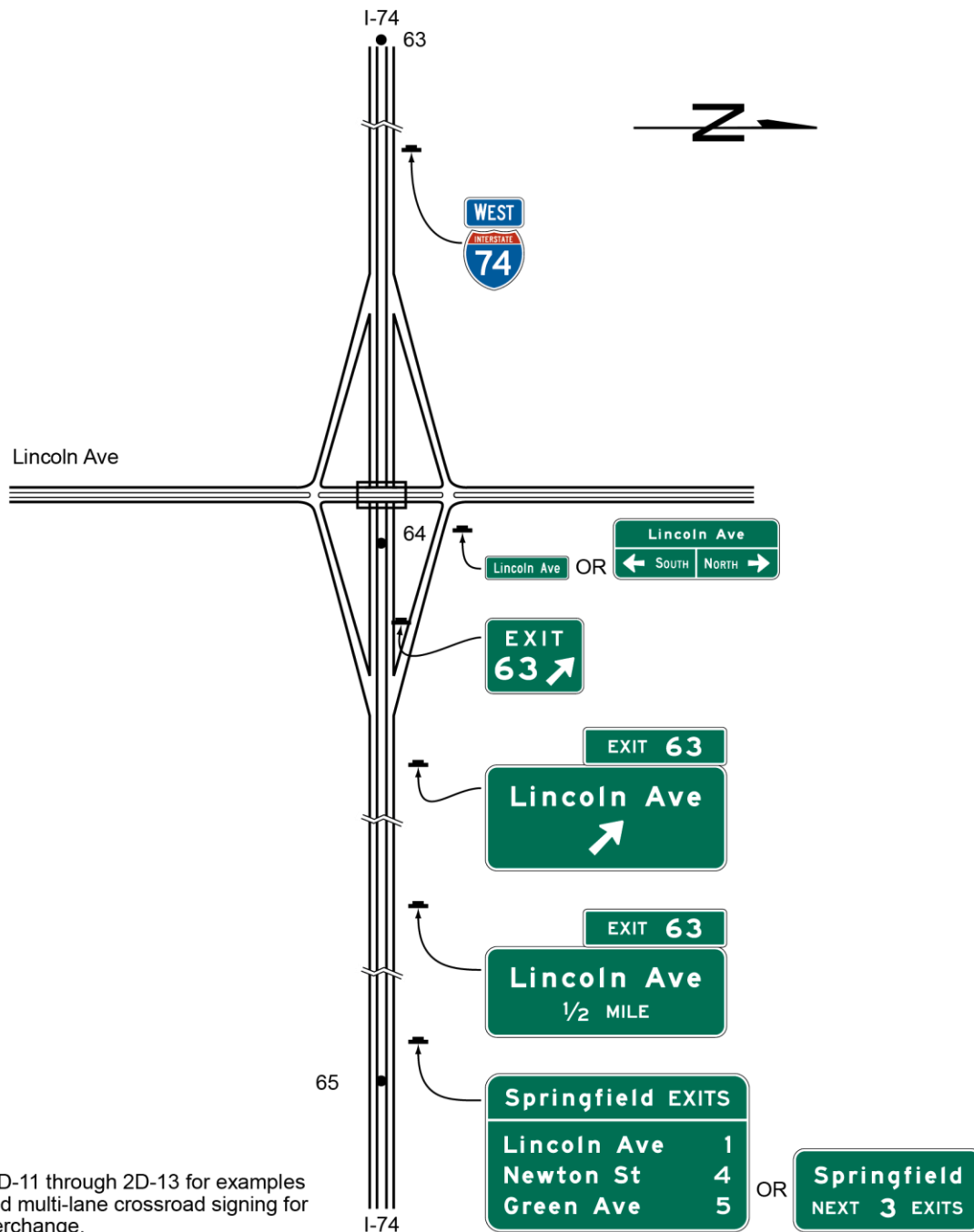

Section 2E.51 Minor Interchange

Option:

01 Less signing may be used for minor interchanges (see Section 2E-22) because such interchanges customarily serve low volumes of local traffic.

Support:

02 Examples of guide signs for minor interchanges are shown in Figure 2E-40. At the time of publication for this edition of the OMUTCD there are no minor interchanges in Ohio.

Figure 2E-40. Examples of Guide Signs for a Minor Interchange

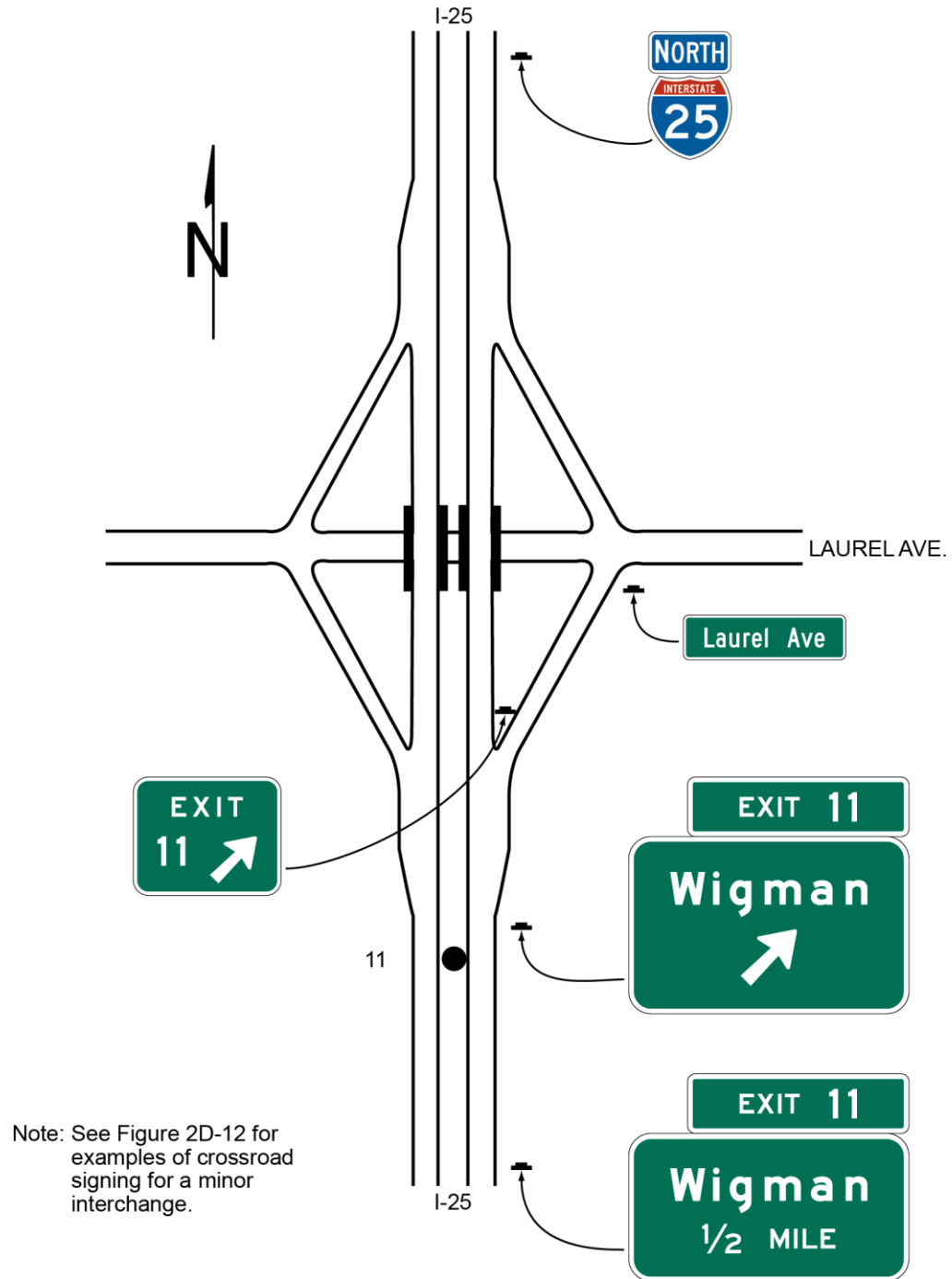

Standard:

- 03 **At least one Advance Guide sign and an Exit Gore sign shall be used at a minor interchange.**

Guidance:

- 04 *An Exit Direction sign should also be used.*

Section 2E.52 Signing on Conventional Road Approaches and Connecting Roadways

Support:

- 01 Section 2D.45 contains information regarding the signing on conventional roads on the approaches to interchanges and the signing on connecting roadways.

Section 2E.53 Wrong-Way Traffic Control at Interchange Ramps

Support:

01 Section 2B.41 contains information regarding the use of regulatory signs to deter wrong-way movements at intersections of freeway or expressway ramps with conventional roads, and in the area where entrance ramps intersect with the mainline lanes.

02 Section 2D.46 contains information regarding the use of a Directional assembly or a guide sign to mark the entrance to a freeway or expressway from a conventional road.

Section 2E.54 Weigh Station Signing (D8-H2)

Standard:

01 **Weigh Station signing on freeways and expressways shall be the same as that provided in Section 2D.49, except for lettering size and the advance posting distance for the Exit Direction (D8-H2) sign, which shall be located a minimum of 1,500 feet in advance of the gore.**

Support:

02 Weigh Station sign layouts for freeway and expressway applications are shown in the SDMM (see Section 1A.11).

CHAPTER 2F. TOLL ROAD SIGNS

Section 2F.01 Scope

Support:

01 Toll highways are typically limited-access freeway or expressway facilities. A portion of or an entire route might be a toll highway, or a bridge, tunnel, or other crossing point might be the only toll portion of a highway. A toll highway might be a conventional road. The general signing requirements for toll roads will depend on the type of facility and access (freeway, expressway, or conventional road). The provisions of Chapters 2D and 2E will generally apply for guide signs along the toll facility that direct road users within and off the facility where exit points and geometric configurations are not dependent specifically on the collection of tolls. The aspect of tolling and the presence of toll plazas or collection points necessitate additional considerations in the typical signing needs. The notification of the collection of tolls in advance of and at entry points to the toll highway also necessitate additional modifications to the typical signing.

02 The scope of this Section applies to a route or facility on which all lanes are tolled. Chapter 2G contains provisions for the signing of managed lanes within an otherwise non-toll facility that employ tolling or pricing as an operational strategy to manage congestion levels.

Standard:

03 **Except where specifically provided in this Chapter, the provisions of other Chapters in Part 2 shall apply to toll roads.**

Section 2F.02 Sizes of Toll Road Signs

Standard:

01 **Except as provided in Section 2A.11, the sizes of toll road signs that have standardized designs shall be as shown in Table 2F-1 and the “Sign Designs and Markings Manual” (SDMM) (see Section 1A.11).**

Support:

02 Section 2A.11 contains information regarding the applicability of the various columns in Table 2F-1.

Option:

03 Signs larger than those shown in Table 2F-1 may be used (see Section 2A.11).

Section 2F.03 Use of Purple Backgrounds and Underlay Panels with Electronic Toll Collection (ETC) Account Pictographs

Standard:

01 **Use of the color purple on any sign shall comply with the provisions of Sections 1A.12 and 2A.10. Except as provided in Sections 2F.12 and 2F.16, purple as a background color shall be used only when the information associated with the appropriate ETC account is displayed on that portion of the sign. The background color of the remaining portion of such signs shall comply with the provisions of Sections 1A.12 and 2A.10 as appropriate for a regulatory, warning, or guide sign. Purple shall not be used as a background color to display a destination, action message, or other legend that is not a display of the requirement for all vehicles to have a registered ETC account.**

02 **If only vehicles with registered ETC accounts are allowed to use a highway lane, a toll plaza lane, an open-road tolling lane, or all lanes of a toll highway or connection, the signs for such lanes or highways shall incorporate the pictograph (see Chapter 2A) adopted by the toll facility’s ETC payment system and the regulatory message ONLY. Except for ETC pictographs whose predominant background color is purple, if incorporated within the green background of a guide sign, the ETC pictograph shall be on a white rectangular or square panel set on a purple underlay panel with a white border. For rectangular ETC pictographs whose predominant background color is purple, a white border shall be used at the outer edges of the purple rectangle to provide contrast between the pictograph and the sign background color.**

03 **If an ETC pictograph is used on a separate plaque with a guide sign or on a header panel within a guide sign, the plaque or the header panel shall have a purple background with a white border and**

Table 2F-1. Toll Road Sign and Plaque Minimum Sizes¹

Sign or Plaque	Sign Designation	Section	Conventional		Expressway	Freeway	Minimum	Oversized
			Single Lane	Multi-Lane				
Toll Rate	R3-28	2F.05	—	—	114 x 48	—	—	—
PAY TOLL (plaque)	R3-29P	2F.05	—	—	24 x 18	—	—	—
TAKE TICKET plaque)	R3-30P	2F.05	—	—	24 x 18	—	—	—
PAY TOLL XX MILES CARS (price)	W9-6	2F.06	96 x 66	—	96 x 66	—	—	—
PAY TOLL XX MILES - CARS (price) (plaque)	W9-6P	2F.07	288 ² x 36	—	288 ² x 36	—	—	—
STOP AHEAD PAY TOLL CARS (price)	W9-6a	2F.08	114 x 66	—	114 x 66	—	—	—
STOP AHEAD PAY TOLL (plaque)	W9-6aP	2F.09	252 ² x 36	—	252 ² x 36	—	—	—
LAST EXIT BEFORE TOLL (plaque)	W16-16P	2F.10	—	—	252 ² x 36	—	—	—
TOLL	M4-15	2F.11	24 x 12	—	36 x 18	24 x 12	—	36 x 18
NO CASH	M4-16	2F.12	24 x 12	—	36 x 18	24 x 12	—	36 x 18
Toll Collector Symbol	M4-17	2F.13	—	—	48 x 48	—	—	—
Exact Change Symbol	M4-18	2F.13	—	—	48 x 48	—	—	—
ETC Only	M4-20	2F.12	24 x 24	—	36 x 36	24 x 24	—	36 x 36

Notes:

1. a.) Larger signs may be used when appropriate.
b.) Dimensions in inches are shown as width x height.
2. The width shown represents the minimum dimension. The width shall be increased as appropriate to match the width of the guide sign.

the ETC pictograph shall have a white border to provide contrast between the pictograph and the background of the plaque or header panel.

- 04 Purple underlay panels for ETC pictographs or purple backgrounds for plaques and header panels shall only be used in the manner described in Paragraphs 1 through 3 to convey the requirement of a registered ETC account on signs for lanes reserved exclusively for vehicles with such an account and on directional signs to an ETC account-only facility from a non-toll facility or from a toll facility that accepts multiple payment forms.

Support:

- 05 Figure 2F-1 shows examples of ETC account pictographs, their use with various background colors, and modifications involving underlay panels.

- 06 Section 2F.04 contains provisions regarding the size of pictographs for ETC accounts.

Section 2F.04 Size of ETC Pictographs

Standard:

- 01 The ETC pictograph (see Chapter 2A) shall be of a size that makes it a prominent feature of the sign legend as necessary for conspicuity for those road users with registered ETC accounts seeking such direction, as well as for those road users who do not have ETC accounts so that it is clear to them to avoid such direction when applicable.

Guidance:

- 02 An ETC pictograph that is in the shape of a horizontal rectangle should have a minimum height between approximately 1.5 and 2 times the upper-case letter height of the principal legend on the sign. The width of an ETC pictograph in the shape of a horizontal rectangle should be between approximately two and three

Figure 2F-1. Examples of ETC Account Pictographs and Use of Purple Backgrounds and Underlay Panels

A - PICTOGRAPH DESIGN WITH A PURPLE BACKGROUND AND A WHITE CONTRASTING BORDER

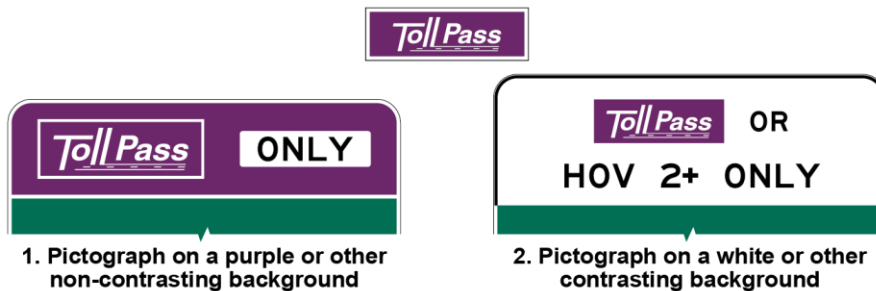

B - PICTOGRAPH DESIGN WITH A BACKGROUND COLOR OTHER THAN PURPLE, SHOWN ON A PURPLE UNDERLAY PANEL WITH A WHITE CONTRASTING BORDER



times the height of the pictograph. When the pictograph is the principal legend on the sign, such as for advance guide signs for open-road tolling lanes (see Section 2F.15), the minimum height of a horizontal rectangular ETC pictograph should be consistent with that of a route shield prescribed for the particular application and type of sign.

- 03 For ETC pictographs whose shape is square, circular, or otherwise similar in height and width, or is a vertical rectangle, the same basic principles for conspicuity and placement should be followed. ETC pictographs whose shape is not in that of a horizontal rectangle should be suitably sized to facilitate conspicuity as described in Paragraph 1 and should be of a similar approximate area as the horizontal rectangular pictographs designed in accordance with the height and width as provided in Paragraph 2.

Section 2F.05 Regulatory Signs for Toll Plazas

Support:

- 01 Toll plaza operations often include lane-specific restrictions on vehicle type, forms of payment accepted, and speed limits or required stops. Vehicles are typically required to come to a stop to pay the toll or receive a toll ticket in the attended and exact change or automatic lanes. Electronic toll collection (ETC) lanes with favorable geometrics typically allow vehicles to move through the toll plaza without stopping, but usually within a set regulatory speed limit or advisory speed. In some ETC lanes and in most lanes that accommodate non-ETC vehicles, a stop might be required while the ETC payment is processed because of geometric or other conditions.

Guidance:

- 02 Regulatory signs applicable only to a particular lane or lanes should be located in a position that makes their applicability clear to road users approaching the toll plaza.
- 03 Regulatory signs, or regulatory panels within guide signs, indicating restrictions on vehicle type and forms of toll payment accepted at a specific toll plaza lane should be installed over the applicable lane

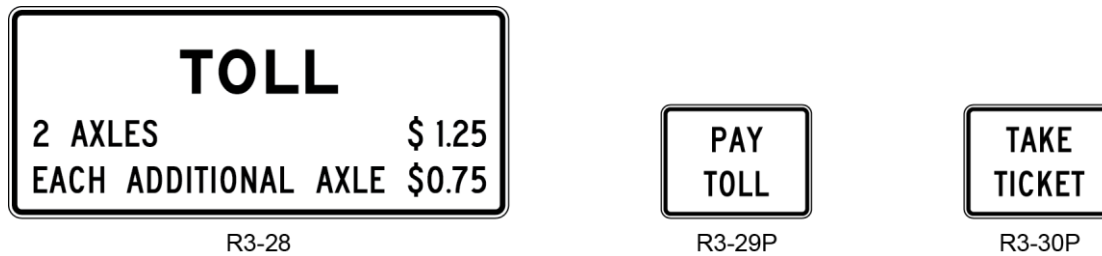
Figure 2F-2. Toll Plaza Regulatory Signs and Plaques

either on the toll plaza canopy or on a separate structure immediately in advance of the canopy located in a manner such that each sign is clearly related to an individual toll lane.

Support:

04 Section 2F.13 contains information regarding the incorporation of regulatory messages into guide signs for toll plazas.

05 Section 2F.16 contains information regarding the design and use of toll plaza canopy signs.

Guidance:

06 *One or more Speed Limit (R2-1) signs (see Section 2B.13) should be installed in the locations provided in Paragraph 8 for an ETC-Only lane at a toll plaza in which an enforceable regulatory speed limit is established for a lane in which it is intended that vehicles move through the toll plaza without stopping while toll payments requiring stops occur in other lanes at the toll plaza. The speed limit displayed on the signs should be based on an engineering study taking into account the geometry of the plaza and the lanes and other appropriate safety and operational factors.*

07 *A Speed Limit (R2-1) sign should not be installed for a toll plaza lane that is controlled by a STOP (R1-1) sign or where a stop is required.*

Option:

08 Speed limit signs may be installed over the applicable lane on the toll plaza canopy, on the approach end of the toll booth island, on the toll booth itself, or on a vertical element of the canopy structure. Down arrows or diagonally downward-pointing directional arrows may be used to supplement the speed limit signs if an engineering study or engineering judgment indicates that the arrow is needed to clarify the applicability of a sign to a specific lane or to improve compliance.

Standard:

09 **A STOP (R1-1) sign shall not be installed for a toll plaza lane that is operated as an ETC-Only lane and that is designed for tolls to be collected while vehicles continue moving.**

Option:

10 A STOP (R1-1) sign may be installed to require vehicles to come to a complete stop to pay a toll in an attended or exact change lane, even if that lane is also available for optional use by vehicles with registered ETC accounts. A PAY TOLL (R3-29P) or TAKE TICKET (R3-30P) plaque (see Figure 2F-2), as appropriate to the operation, may be installed directly under the STOP (R1-1) sign for a toll plaza lane, if needed.

11 The mounting height of the STOP sign and any supplemental plaque may be less than the normal mounting height requirements if constrained by the physical features of the toll island or toll plaza.

12 The lateral offset of a STOP or other regulatory sign located within a toll plaza island may be reduced to a minimum of 1 foot from the face of the toll island or raised barrier to the nearest edge of the sign.

Guidance:

13 *If used, a STOP (R1-1) sign for a toll plaza cash payment lane should be located in a longitudinal position as near as practical to the point where a vehicle is expected to stop to pay the toll or take a ticket.*

Option:

14 A Toll Rate (R3-28) sign (see Figure 2F-2) may be installed in advance of the toll plaza to indicate the toll applicable to the various vehicle types.

Guidance:

- 15 *If used, the Toll Rate (R3-28) sign should be located between the toll plaza and the first advance sign informing road users of the toll plaza.*
- 16 *The R3-28 sign should not contain more than three lines of legend. Each line that shows a toll amount should display only a single toll amount.*

Option:

- 17 Additional toll rate information exceeding three lines of legend may be displayed on the toll booth adjacent to the payment window of an attended lane or the payment receptacle of an exact change or automatic lane where it is visible to a road user who has stopped to pay the toll, but is not visible to approaching road users who have not yet entered the toll lane.

Section 2F.06 Pay Toll Advance Warning Sign (W9-6)**Standard:**

- 01 **The Pay Toll Advance Warning (W9-6) sign shall be a horizontal rectangle with a black legend and border on a yellow background. The legend shall include the distance to the toll plaza and, except for toll-ticket facilities, the toll for passenger or 2-axle vehicles (see Figure 2F-3). Where the toll for passenger or 2-axle vehicles is variable by time of day, a changeable message element shall be incorporated into the W9-6 sign to display the toll in effect. For toll plazas where road users entering a toll-ticket facility are issued a toll ticket, the legend PAY TOLL shall be replaced with a suitable legend such as TAKE TICKET.**

Guidance:

- 02 *The Pay Toll Advance Warning sign should be installed overhead at approximately 1 mile and 1/2 mile in advance of mainline toll plazas at which some or all lanes are required to come to a stop to pay a toll (see Sections 2F.14 and 2F.15).*

Option:

- 03 If there is insufficient space for the W9-6 sign at the 1-mile or 1/2-mile advance locations, the Pay Toll Advance Warning (W9-6P) plaque (see Section 2F.07) may be installed at those advance locations above the appropriate guide sign(s) that relate to toll payment types.
- 04 An additional W9-6 sign may be installed approximately 2 miles in advance of a mainline toll plaza. This sign may be either overhead or post-mounted.
- 05 If the visibility of a ramp toll plaza at which some or all lanes are required to come to a stop to pay a toll is limited, the W9-6 sign may also be installed in advance of the ramp toll plaza.

Section 2F.07 Pay Toll Advance Warning Plaque (W9-6P)

Option:

- 01 The Pay Toll Advance Warning (W9-6P) plaque (see Figure 2F-3) may be installed above the appropriate guide sign(s) relating to toll payment types at the 1-mile and/or 1/2-mile advance locations on the approach to a toll plaza if there is insufficient space for the W9-6 sign (see Section 2F.06) at those advance locations.

Standard:

- 02 **The W9-6P plaque shall be a horizontal rectangle with black legend and border on a yellow background. The legend shall include the distance to the toll plaza and, except for toll-ticket facilities, the toll for passenger or 2-axle vehicles. Where the toll for passenger or 2-axle vehicles is variable by time of day, a changeable message element shall be incorporated into the W9-6P plaque to display the toll in effect. For toll plazas where road users entering a toll-ticket facility are issued a toll ticket, the legend PAY TOLL shall be replaced with a suitable legend such as TAKE TICKET.**

Option:

- 03 The distance to the toll plaza may be omitted from the W9-6P plaque if the distance is displayed on the guide sign that the plaque accompanies.
- 04 The toll for passenger or 2-axle vehicles may be omitted from the W9-6P plaque if the toll information is displayed on the guide sign that the plaque accompanies.

Figure 2F-3. Toll Plaza Warning Signs and Plaques



W9-6



W9-6a



W9-6P



W9-6aP



W16-16P

Section 2F.08 Stop Ahead Pay Toll Warning Sign (W9-6a)

Standard:

- 01 The Stop Ahead Pay Toll (W9-6a) sign shall be a horizontal rectangle with a black legend and border on a yellow background. The legend shall include STOP AHEAD PAY TOLL and, except for toll-ticket facilities, the toll for passenger or 2-axle vehicles (see Figure 2F-3). Where the toll for passenger or 2-axle vehicles is variable by time of day, a changeable message element shall be incorporated into the W9-6a sign to display the toll in effect. For toll plazas where road users entering a toll-ticket facility are issued a toll ticket, the legend PAY TOLL shall be replaced with a suitable legend such as TAKE TICKET.

Guidance:

- 02 The Stop Ahead Pay Toll sign should be installed overhead downstream from the W9-6 sign that is 1/2 mile in advance of a mainline toll plaza where some or all of the lanes are required to come to a stop to pay a toll (see Sections 2F.14 and 2F.15). The location of the overhead sign should coincide with the approximate location where the mainline lanes begin to widen on the approach to the toll plaza lanes.
- 03 Where open-road tolling is used in addition to a toll plaza at a particular location, the W9-6a sign should be located such that the message is clearly related to the lanes that access the toll plaza and not to the open-road tolling lanes.

Option:

- 04 If there is insufficient space for the W9-6a sign at the recommended location, the Stop Ahead Pay Toll (W9-6aP) plaque (see Section 2F.09) may be installed at that location above the appropriate guide sign that relates to toll payment types.

- 05 If the visibility of a ramp toll plaza at which some or all lanes are required to come to a stop to pay a toll is limited, the W9-6a sign may also be installed in advance of the ramp toll plaza.

Figure 2F-4. ETC Account-Only Auxiliary Signs for Use in Route Sign Assemblies

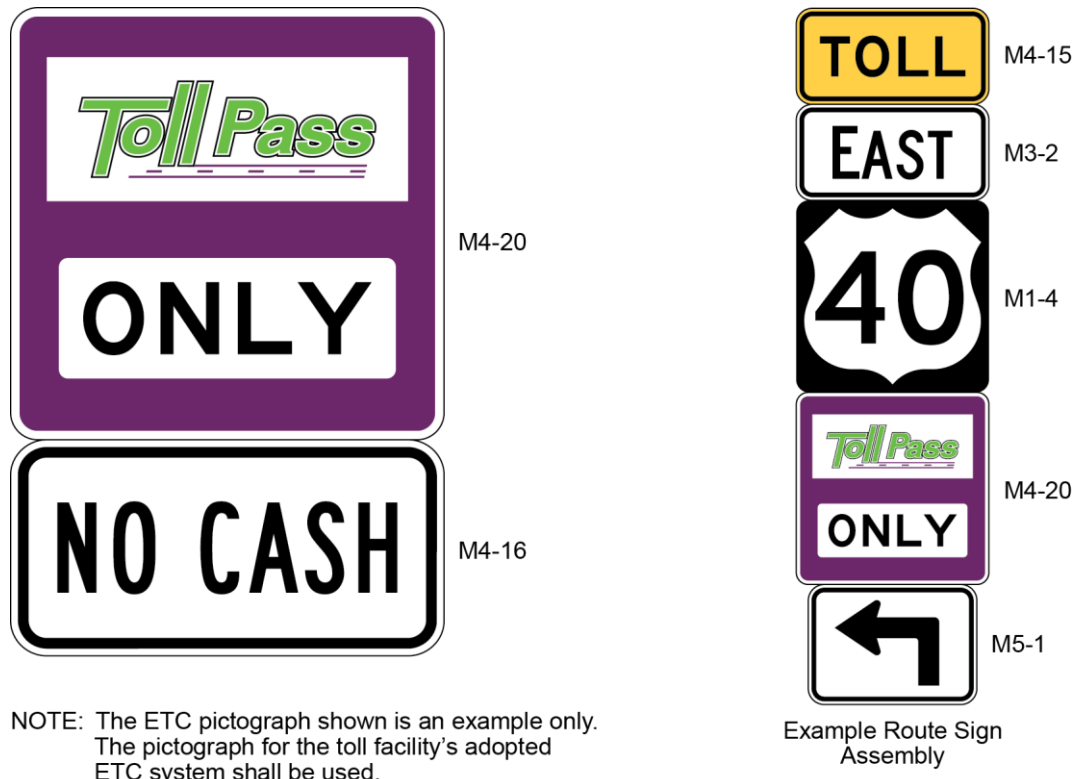

Section 2F.09 Stop Ahead Pay Toll Warning Plaque (W9-6aP)

Option:

- 01 The Stop Ahead Pay Toll (W9-6aP) plaque (see Figure 2F-3) may be installed above the appropriate guide sign at the location specified for the Stop Ahead Pay Toll (W9-6a) sign (see Section 2F.08) if there is insufficient space for the W9-6a sign at that location.

Standard:

- 02 The W9-6aP plaque shall be a horizontal rectangle with black legend and border on a yellow background. The legend shall include STOP AHEAD PAY TOLL and, except for toll-ticket facilities, the toll for passenger or 2-axle vehicles. Where the toll for passenger or 2-axle vehicles is variable by time of day, a changeable message element shall be incorporated into the W9-6aP plaque to display the toll in effect. For toll plazas where road users entering a toll-ticket facility are issued a toll ticket, the legend PAY TOLL shall be replaced with a suitable legend such as TAKE TICKET.

Option:

- 03 The toll for passenger or 2-axle vehicles may be omitted from the W9-6aP plaque if the toll information is displayed on the guide sign that the plaque accompanies.

Section 2F.10 LAST EXIT BEFORE TOLL Warning Plaque (W16-16P)

Guidance:

- 01 The LAST EXIT BEFORE TOLL (W16-16P) plaque (see Figure 2F-3) should be used to notify road users of the last exit from a highway before it becomes a facility on which toll payments are required. The plaque should be installed above or below the appropriate guide signs for the exit (see Sections 2E.33 and 2E.36).

Standard:

- 02 The W16-16P plaque shall have a black legend and border on a yellow background.

Section 2F.11 TOLL Auxiliary Sign (M4-15)**Standard:**

- 01 The TOLL (M4-15) auxiliary sign (see Figure 2F-4) shall have a black legend and border on a yellow background and shall be mounted directly above the route sign of a numbered toll highway or, if used, above the cardinal direction and alternative route auxiliary signs, in any route sign assembly providing directions from a non-toll highway to the toll highway or to a segment of a highway on which the payment of a toll is required.

Section 2F.12 Electronic Toll Collection (ETC) Account-Only Auxiliary Signs (M4-16 and M4-20)**Standard:**

- 01 In any route sign assembly providing directions from a non-toll highway to a toll facility, or to a tolled segment of a highway, where electronic toll collection (ETC) is the only payment method accepted and all vehicles are required to have a registered ETC account, the ETC Account-Only (M4-20) auxiliary sign (see Figure 2F-4) shall be mounted directly below the route sign of the numbered or named toll facility. The M4-20 auxiliary sign shall have a white border and purple background and incorporate the pictograph adopted by the toll facility's ETC payment system and the word ONLY in black letters on a white panel set on the purple background of the sign.

Option:

- 02 The NO CASH (M4-16) auxiliary sign (see Figure 2F-4) with a black legend and border on a white background may be used in a route sign assembly directly below the M4-20 auxiliary sign.

Section 2F.13 Toll Facility and Toll Plaza Guide Signs – General**Support:**

- 01 Toll plazas are used on many toll highways, bridges, and tunnels for collection of tolls from road users. Electronic toll collection and/or open-road tolling might also be used on such facilities, either in addition to or in place of collecting toll payments at toll plazas.
- 02 Chapter 2G contains information regarding signs for preferential and managed lanes that are applicable to toll roads.
- 03 Chapter 3E contains information regarding pavement markings for certain toll plaza applications.

Standard:

- 04 Directional assemblies for entrances to a toll highway or to a road leading directly to a toll highway with no opportunity to exit before paying or being charged a toll, shall clearly indicate that the facility is a toll facility. The TOLL (M4-15) auxiliary sign (see Section 2F.11) shall be used above the route sign of a numbered toll facility in any route sign assembly that provides directions to the toll route from another highway.
- 05 A rectangular panel with the black legend TOLL on a yellow background shall be incorporated into the guide signs leading road users to a toll highway (see Figure 2F-5).
- 06 Guide signs for toll highways, toll plazas, and tolled or priced managed lanes (see Chapter 2G) shall have white legends and borders on green backgrounds, except as specifically provided by Sections 2F.13 through 2F.16.

Option:

- 07 Where conditions do not permit separate signs, or where it is important to associate a particular regulatory or warning message with specific guidance information, regulatory and/or warning messages may be combined with guide signs for toll plazas using plaques, header panels, or rectangular regulatory or warning panels incorporated within the guide signs, as long as the proper legend and background colors are preserved.

Standard:

- 08 When regulatory messages are incorporated within a guide sign, they shall be on a rectangular panel with black legend on a white background. When warning messages are incorporated within a guide sign, they shall be on a rectangular panel with black legend on a yellow background.

- 09 Figure 2F-5 shows examples of guide signs for entrances to various types of toll highways and for ETC account-only entrances to non-toll highways.

Standard:

- 10 **Signing for entrances to toll highways where ETC is employed only through license plate character recognition such that road users are not required to establish a toll account or register their vehicle equipment shall comply with the provisions of Paragraphs 4 and 5 (see Figure 2F-6).**

- 11 **If only vehicles with registered ETC accounts are allowed to use a toll highway, the guide signs for entrances to such facilities shall incorporate the pictograph adopted by the toll facility's ETC payment system and the regulatory message ONLY (see Figures 2F-1, 2F-5, and 2F-6). The use, size, and placement of the ETC pictograph shall comply with the provisions of Sections 2F.03 and 2F.04.**

Support:

- 12 Sections 2F.11, 2F.12, and 2F.17 contain additional provisions regarding signs for toll highways that only accept ETC payments.

- 13 Sections 2G.16 through 2G.18 contain additional provisions regarding signs for priced managed lanes that only accept ETC payments.

Option:

- 14 Where a toll highway on which tolls are collected only electronically also accepts payments from registered toll account users and those road users not registered in a toll account program are assessed a nominal surcharge in addition to the toll, or registered toll account users are assessed a discounted toll, such information may be displayed on a separate information sign near the entrance to such a facility (see Figure 2F-6).

Support:

- 15 Figure 2F-7 shows an example of guide signs for alternative toll and non-toll ramp connections to a non-toll highway.

- 16 Many different ETC payment systems are used by the various toll facility operators. Some of these systems accept payment from other systems' accounts.

Option:

- 17 Where a facility will accept payments from other systems' accounts in addition to its primary ETC-account payment system, such information may be displayed on a separate information sign near the entrances to such a facility or in advance of a toll plaza or open-road tolling lanes, as space allows between primary signs.

Guidance:

- 18 *Guide signs for toll plazas should be designed in accordance with the general principles of guide signs and the specific provisions of Chapter 2E.*

- 19 *Signs for toll plazas should systematically provide road users with advance and toll plaza lane-specific information regarding:*

- A. *The amount of the toll, the types of payment accepted, and the type(s) of registered ETC accounts accepted for payment;*
- B. *Which lane or lanes are required or allowed to be used for each available payment type; and*
- C. *Restrictions on the use of a toll plaza lane or lanes by certain types of vehicles (such as cars only or no trucks).*

Standard:

- 20 **Signs for attended lanes at toll plazas shall include word messages such as FULL SERVICE, CASH, CHANGE, or RECEIPTS (see Figures 2F-8 through 2F-11).**

Option:

- 21 Signs for attended lanes at toll plazas may incorporate the Toll Taker (M4-17) symbol (see Figures 2F-8 and 2F-9), in a size that makes the symbol the predominant feature of the sign, to supplement the required word message.

Figure 2F-5. Examples of Guide Signs for Entrances to Toll Highways or Ramps

A - ENTRANCE TO A TOLL HIGHWAY ON WHICH REGISTRATION IN A TOLL ACCOUNT PROGRAM IS NOT REQUIRED



B - ENTRANCE TO AN ETC ACCOUNT-ONLY TOLL HIGHWAY OR ENTRANCE TO A TOLL HIGHWAY VIA AN ETC ACCOUNT-ONLY RAMP



C - ENTRANCE TO A NON-TOLL HIGHWAY VIA AN ETC ACCOUNT-ONLY TOLL ENTRANCE RAMP

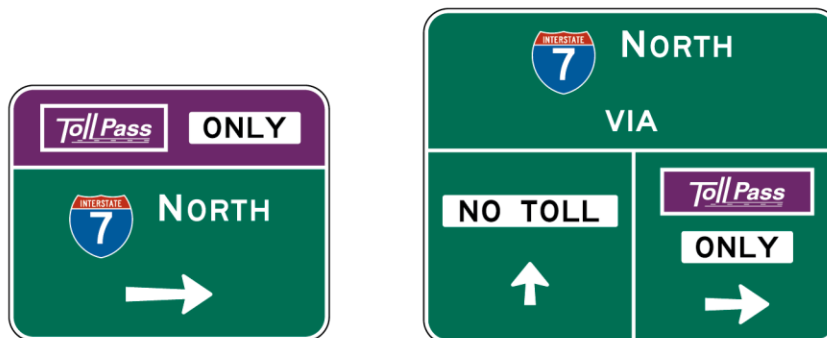

(the toll entrance is the only connection provided in the vicinity)

(an alternate non-toll entrance is provided in the vicinity)

Note: The ETC pictographs shown are examples only. The pictograph for the toll facility's adopted ETC system shall be used.

Standard:

22 **Signs for Exact Change lanes at toll plazas shall incorporate an appropriate word message, such as EXACT CHANGE and the amount of the toll for passenger vehicles (see Figures 2F-8 through 2F-11).**

Option:

23 Signs for Exact Change lanes at toll plazas may include the Exact Change (M4-18) symbol (see Figures 2F-8 and 2F-9), in a size that makes the symbol the predominant feature of the sign, to supplement the required word message.

Figure 2F-6. Examples of Guide Signs for the Entrance to a Toll Highway on which Tolls are Collected Electronically Only

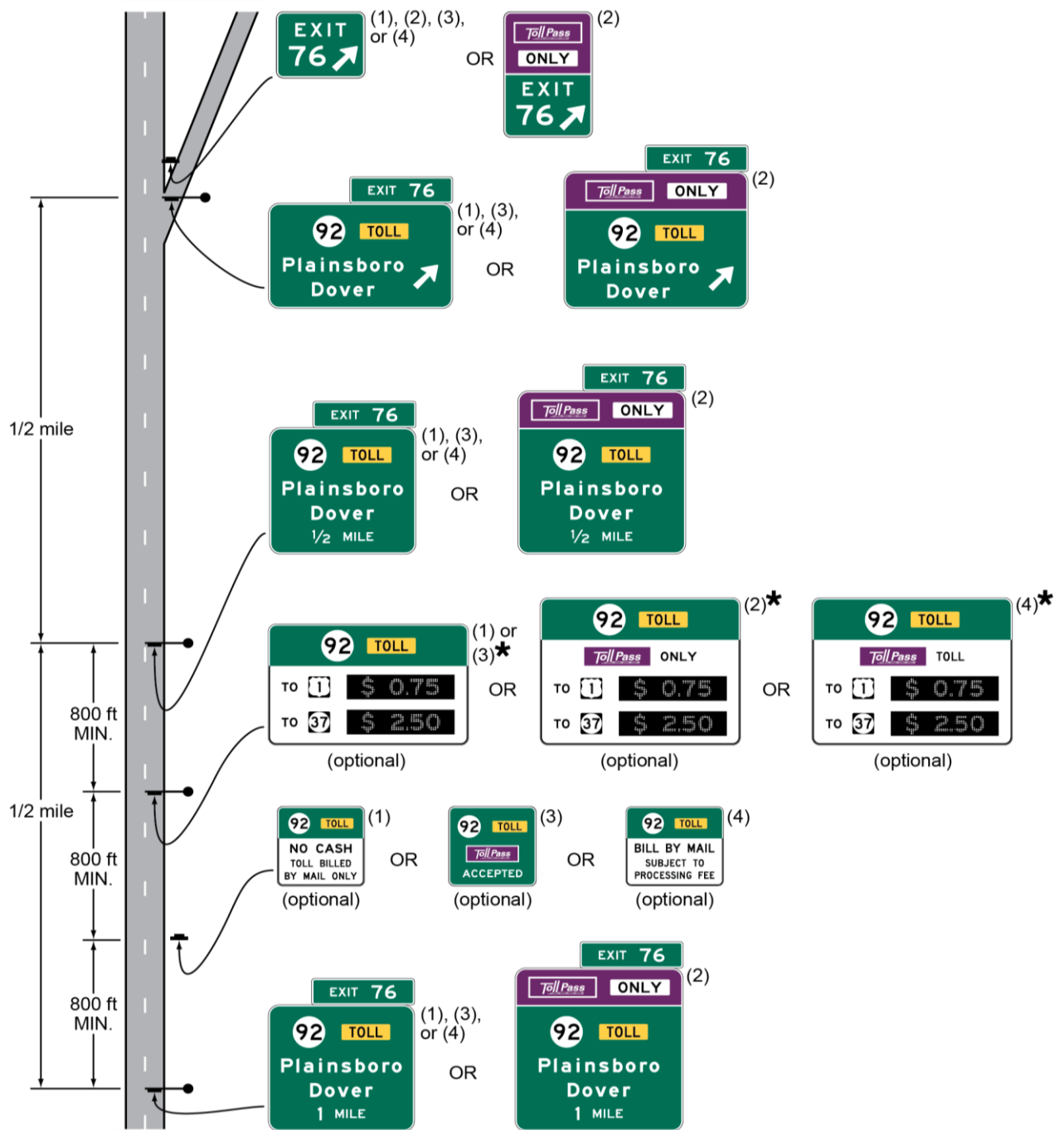

- (1) All tolls are billed through license plate recognition only. A registered toll account or ETC device is not needed.
- (2) All tolls are billed through registered toll accounts only. All vehicles must be registered in an ETC account program.
- (3) Toll payments are also accepted from registered toll accounts. Registered toll accounts might receive a discount from the toll amount displayed on the signs.
- (4) Toll payments are also accepted from registered toll accounts. Registered toll accounts might receive a discount from the toll amount displayed on the signs.
- * For managed toll highways only (see Chapter 2G)

Note: Figures 2D-3 and 2D-4 show the correct design of an Ohio State Route sign.

Figure 2F-7. Examples of Guide Signs for Alternative Toll and Non-Toll Ramp Connections to a Non-Toll Highway

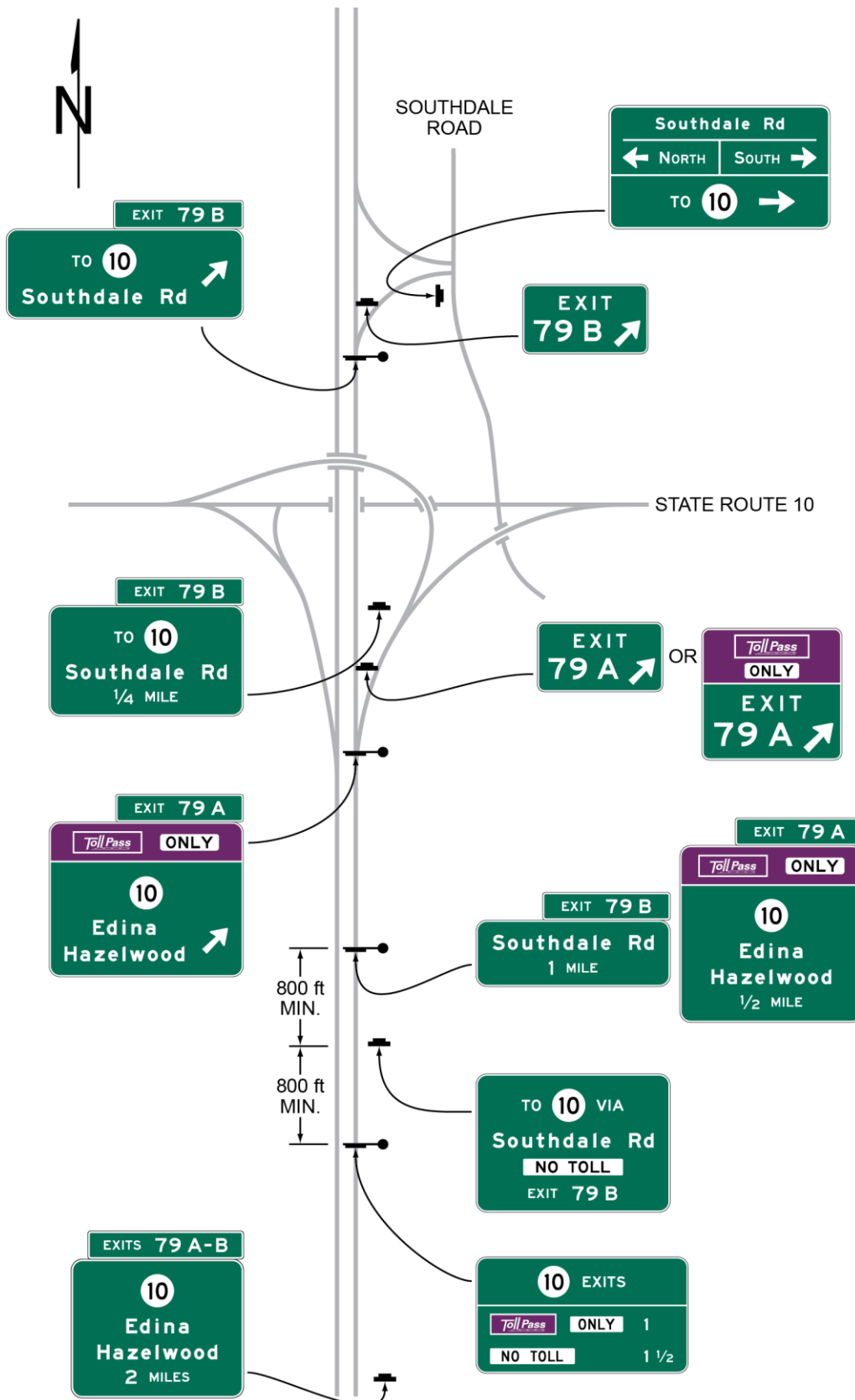

Note: Figures 2D-3 and 2D-4 show the correct design of an Ohio State Route sign.

Figure 2F-8. Examples of Conventional Toll Plaza Advance Signs**Notes:**

1. The M4-17 symbol is optional for an attended lane.
2. The M4-18 symbol is optional for an exact change lane.
3. The ETC pictograph that is shown is only an example. The pictograph for the toll facility's adopted ETC system shall be used.

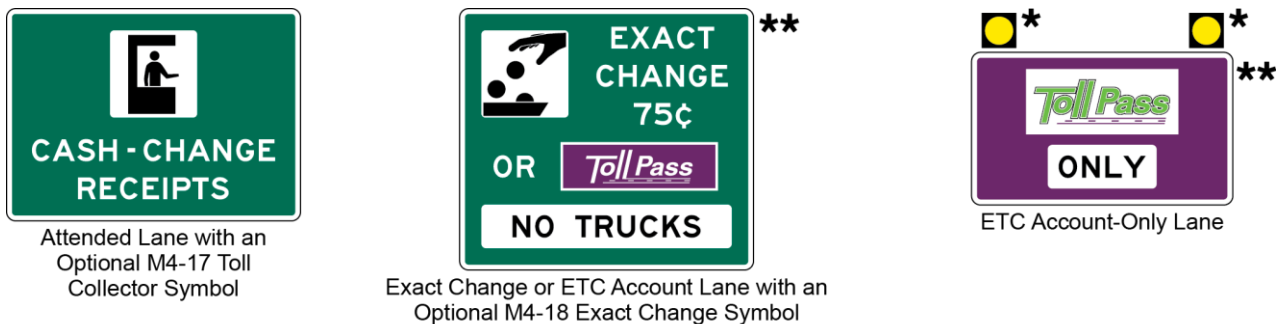
Figure 2F-9. Examples of Toll Plaza Canopy Signs

- * Optional flashing yellow beacons that are separated from any lane-use control signals for the lane (see Section 2F.16)
- ** The ETC pictographs that are shown are only examples. The pictograph for the toll facility's adopted ETC system shall be used.

Standard:

- 24 **If used, the M4-17 and M4-18 symbols shall be used only as panels within guide signs that accompany the required word messages. The M4-17 and M4-18 symbols shall not be used as an independent sign or within a sign assembly.**
 - 25 **If only vehicles with registered ETC accounts are allowed to use a toll plaza lane, the signs for such lanes shall incorporate the pictograph adopted by the toll facility's ETC payment system and the regulatory message ONLY (see Figures 2F-1, 2F-8, 2F-9, and 2F-11). The use, size, and placement of the ETC pictograph shall comply with the provisions of Sections 2F.03 and 2F.04.**
- Option:
- 26 The ETC payment system's pictograph, without a purple underlay or purple header panel, may be used on signs for Exact Change or attended lanes at toll plazas to indicate that vehicles with registered ETC accounts may also use those lanes (see Figure 2F-9).

Section 2F.14 Advance Signs for Conventional Toll Plazas**Guidance:**

- 01 *For conventional toll plazas (those without a divergence onto a separate alignment from mainline-aligned open-road tolling or ETC-Only lanes), one or more sets of overhead advance guide signs complying with the provisions of this Section should be provided. The advance guide signs for multi-lane toll plazas should provide information regarding which lanes to use for all of the toll payment methods accepted at the toll plaza. These signs should include toll plaza lane numbers (if used), or action messages or lane-use information such as LEFT LANE(S), CENTER LANE(S), RIGHT LANE(S), or down arrows over the approximate center of each applicable lane. These signs should also incorporate regulatory messages*

indicating any restrictions or prohibitions on the use of the lanes associated with the various types of payment methods by certain types of vehicles. For mainline toll plazas, these signs should be at least 1/2 mile in advance of the toll plaza, and farther if practical.

02 *Additional guide signs with lane information for the toll payment types should be provided between approximately 1/4 mile and 800 feet in advance of the toll plaza at a location that avoids or minimizes obstruction of toll plaza canopy signs (see Section 2F.16) and lane-use control signals.*

03 *The number, mounting, and/or spacing of sets of advance signs for approaches to toll plazas on ramps, toll bridges, or tunnels, to accommodate a limited distance to the plaza from an intersection or from the start of the approach road to the bridge or tunnel, should be based on an engineering study or engineering judgment.*

Support:

04 Figure 2F-10 shows examples of advance signs for a conventional toll plaza.

Section 2F.15 Advance Signs for Toll Plazas on Diverging Alignments from Open-Road ETC Account-Only Lanes

Support:

01 Open-Road ETC lanes are sometimes located on the normal mainline alignment while the lanes for other toll payment methods are located at a toll plaza on a separate alignment (see Figure 2F-11). Since road users paying cash tolls must diverge from the mainline alignment, similar to a movement for an exit, it is important that the guide signs in advance of and at the point of divergence clearly indicate the required lane use and/or movements.

Guidance:

02 *For toll plazas located on a separate alignment that diverges from mainline-aligned Open-Road ETC lanes where vehicles are required to have a registered ETC account to use the Open-Road Tolling lanes, overhead advance signs should be provided at approximately 1 mile and 1/2 mile in advance of the divergence point. Both the 1-mile and 1/2-mile advance signs should include:*

- A. *The ETC (pictograph) Account-Only guide sign (see Figures 2F-8 and 2F-11) with a down arrow over the center of each lane that will become an Open-Road ETC lane;*
- B. *For the lane or lanes which will diverge to a toll plaza, guide signs conforming to the provisions of Section 2F.13, indicating which lane or lanes will diverge to the toll plaza for the various cash toll payment methods; and*
- C. *Regulatory signs, plaques, or panels within the guide signs, indicating any restrictions or prohibitions of certain types of vehicles from toll plaza lanes associated with the various types of payment methods.*

03 *At or near the theoretical gore of the divergence point, an additional set of overhead guide signs should be provided and should include:*

- A. *The ETC (pictograph) Account-Only guide sign (see Figures 2F-8 and 2F-11) with a down arrow over the center of each Open-Road ETC lane;*
- B. *Guide signs conforming to the provisions of Section 2F.13, with diagonally upward-pointing directional arrow(s) over the approximate center of each lane indicating the direction of the divergence, and providing lane information for all types of payment methods accepted at the toll plaza; and*
- C. *Regulatory signs, plaques, or panels within the guide signs, indicating any restrictions or prohibitions on the use of the toll plaza lanes associated with the various types of payment methods by certain types of vehicles.*

04 *Approximately 800 feet in advance of the toll plaza at a location that avoids or minimizes any obstruction of the toll plaza canopy signs (see Section 2F.16) and lane-use control signals, an additional set of overhead advance signs with lane information for the toll payment types should be provided.*

Standard:

05 **The use of down and directional arrows on the signs at the locations described in Paragraphs 2 through 4 shall comply with the provisions of Section 2D.08.**

06 Figure 2F-11 shows an example of advance signs for toll plazas on a diverging alignment from Open-Road ETC Account-Only Lanes.

07 Section 4K.02 contains information regarding the use of lane-use control signals for Open-Road ETC lanes for temporary lane closure purposes.

Section 2F.16 Toll Plaza Canopy Signs

Standard:

01 **A sign complying with the provisions of Section 2F.13 shall be provided above the center of each lane that is not an Open-Road ETC lane, mounted on or suspended from the toll plaza canopy, or on a separate structure immediately in advance of the plaza located such that each sign is clearly related to an individual toll lane, indicating the payment type(s) accepted in the lane and any restrictions or prohibitions of certain types of vehicles that apply to the lane. Except for toll-ticket systems, the toll for passenger or 2-axle vehicles shall be included on the canopy sign or on a separate sign mounted on the upstream side of the tollbooth.**

02 **The background color of a canopy sign for an ETC Account-Only toll plaza lane shall be purple (see Figure 2F-9).**

Option:

03 Where vehicles are required to have a registered ETC account to use the lane, one or two flashing yellow beacons (see Section 4K.03) may supplement a canopy sign over an ETC Account-Only lane to call special attention to the location of the ETC Account-Only lane within the plaza.

04 The canopy sign for an ETC-Only toll plaza lane in which a regulatory speed limit is not posted and in which vehicles are not required to stop may display an advisory speed within a horizontal rectangular panel with a black legend and yellow background within the bottom portion of the canopy sign.

Standard:

05 **Flashing beacons supplementing a canopy sign over an ETC Account-Only lane shall be mounted directly above or alongside the sign in a manner that is separated from any lane-use control signals for that lane (see Figure 2F-9).**

06 **For multi-lane toll plazas, lane-use control signals (see Section 4K.02) shall be provided above the center of each toll plaza lane that is not an Open-Road ETC lane to indicate the open or closed status of each lane. Lane-use control signals shall not be used to call attention to a lane for a specific toll payment type such as ETC Account-Only lanes.**

Support:

07 Part 6 contains information regarding the closing of a lane for temporary traffic control purposes.

08 Figure 2F-9 shows examples of toll plaza canopy signs.

Section 2F.17 Guide Signs for Entrances to ETC Account-Only Facilities

Support:

01 Some toll highways, bridges, and tunnels are restricted to use only by vehicles with a specific registered ETC account.

Standard:

02 **Where vehicles are required to have a registered ETC account to use an ETC Account-Only facility, guide signs for the facility shall comply with the applicable provisions of Chapter 2E and specifically with the applicable provisions of Section 2F.13.**

03 **Guide signs for the entrance ramps to such ETC Account-Only facilities shall incorporate the pictograph of the toll facility's ETC payment system and the word ONLY in a header panel or plaque designed in accordance with the provisions of Section 2F.13 (see Figure 2F-5).**

Support:

04 Section 2F.12 contains information regarding ETC-Only auxiliary signs for use with route signs in route sign assemblies.

Figure 2F-10. Examples of Mainline Toll Plaza Approach and Canopy Signing

A - ALL TOLL PLAZA LANES ATTENDED
(NO AUTOMATIC OR ELECTRONIC
COLLECTION EQUIPMENT)

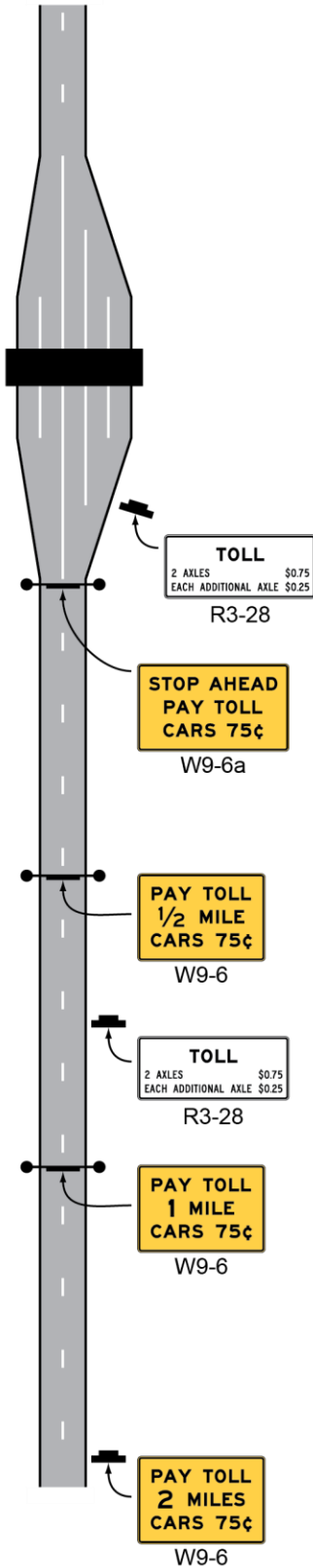

B - EXACT CHANGE AND ATTENDED TOLL LANES

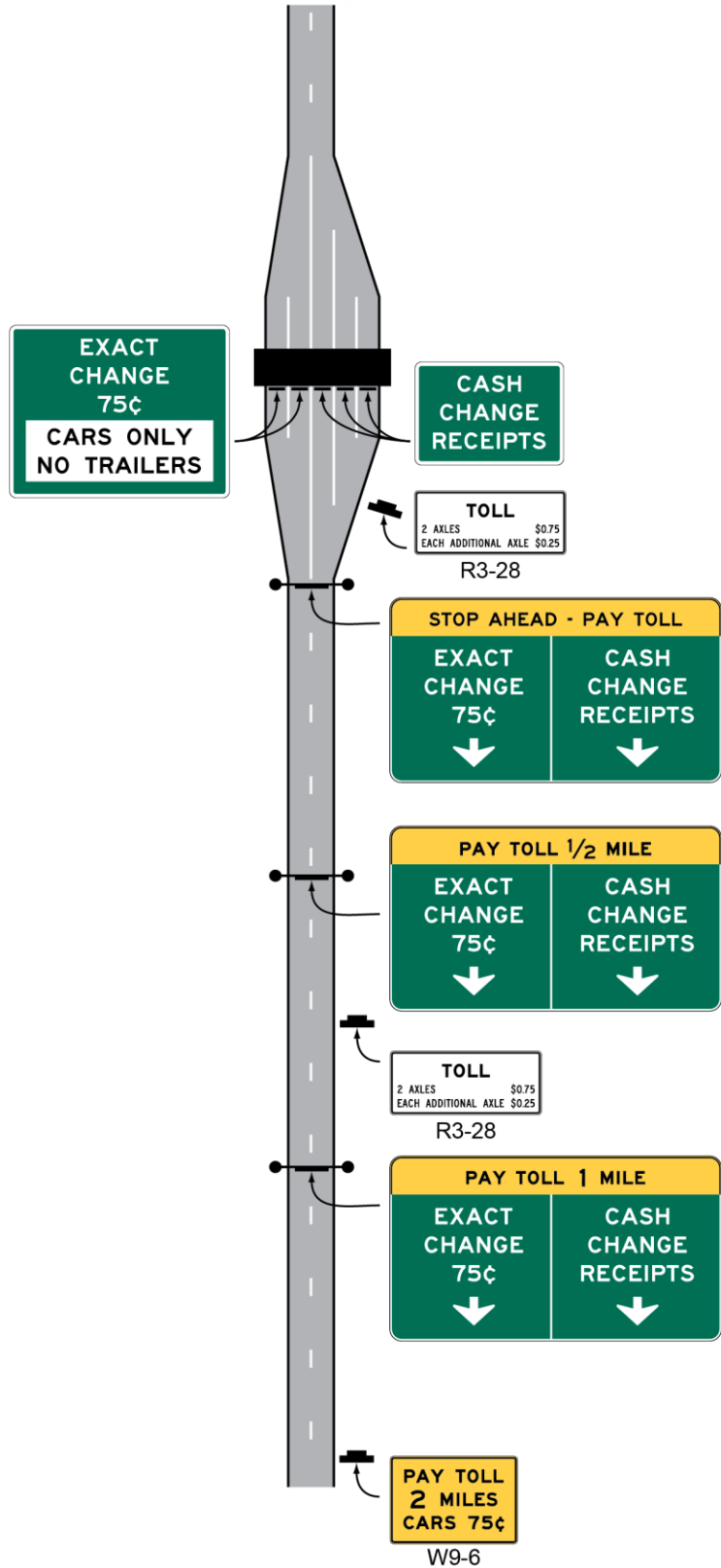
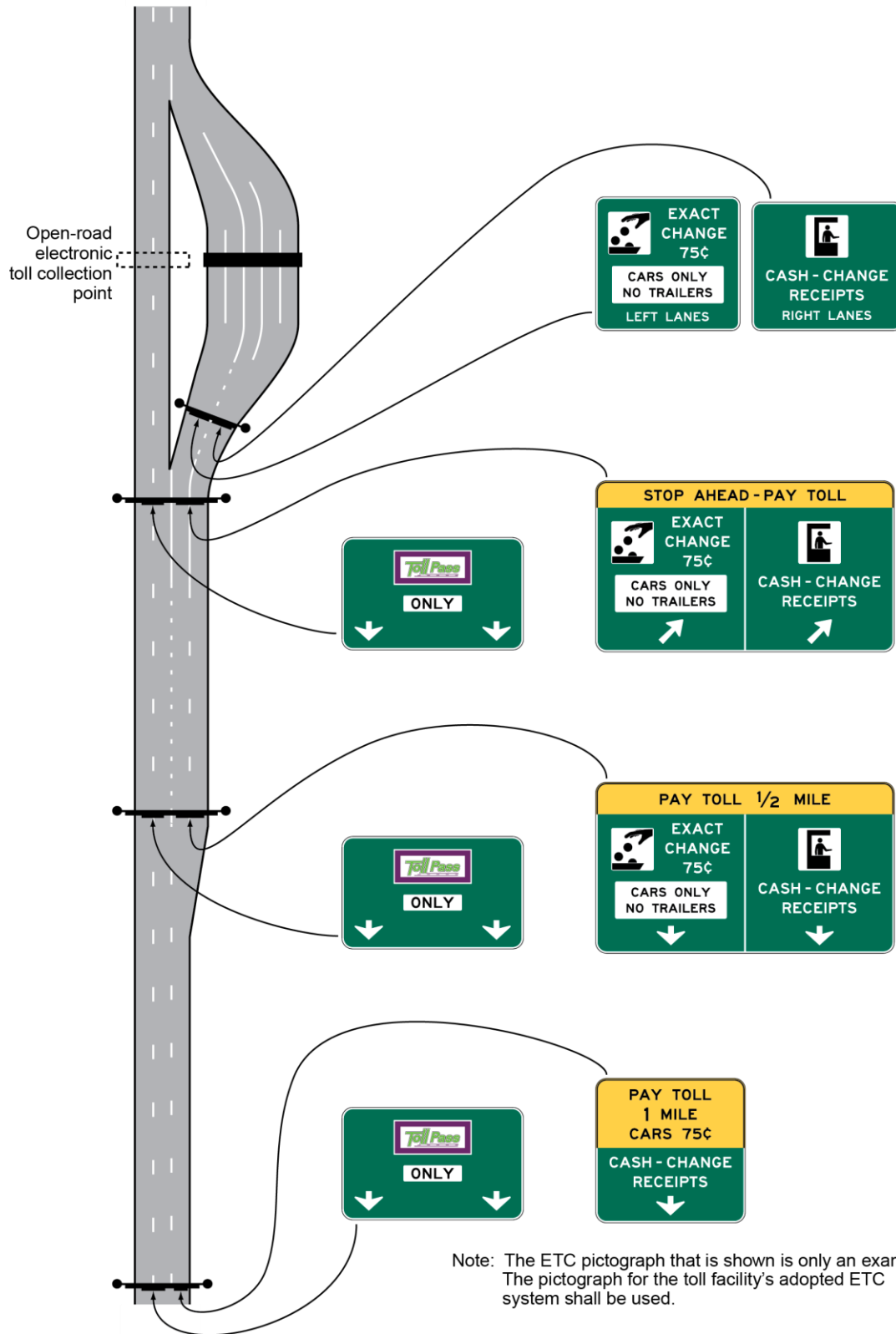

Figure 2F-11. Examples of Guide Signs for a Mainline Toll Plaza on a Diverging Alignment from Open-Road ETC Lanes



Section 2F.18 ETC Program Information Signs**Standard:**

- 01 **Except as provided in Paragraph 2, signs that inform road users of telephone numbers, Internet addresses, including domain names and uniform resource locators (URLs), or e-mail addresses for enrolling in an ETC program of a toll facility or managed lane, obtaining an ETC transponder, and/or obtaining ETC program information shall only be installed in rest areas, parking areas, or similar roadside facilities where the signs are viewed only by pedestrians or occupants of parked vehicles.**

Option:

- 02 ETC program information signs displaying telephone numbers that have no more than four characters may be installed on roadways in locations where they will not obscure the road user's view of higher priority traffic control devices and that are removed from key decision points where the road user's view is more appropriately focused on other traffic control devices, roadway geometry, or traffic conditions, including exit and entrance ramps, intersections, toll plazas, temporary traffic control zones, and areas of limited sight distance.

CHAPTER 2G. PREFERENTIAL AND MANAGED LANE SIGNS

Section 2G.01 Scope

Support:

- 01 Preferential lanes are lanes designated for special traffic uses such as high-occupancy vehicles (HOVs), light rail, buses, taxis, or bicycles. Preferential lane treatments might be as simple as restricting a turning lane to a certain class of vehicles during peak periods, or as sophisticated as providing a separate roadway system within a highway corridor for certain vehicles.
- 02 Preferential lanes might be barrier-separated (on a separate alignment or physically separated from the other travel lanes by a barrier or median), buffer-separated (separated from the adjacent general-purpose lanes only by a narrow buffer area created with longitudinal pavement markings), or contiguous (separated from the adjacent general-purpose lanes only by a lane line). Preferential lanes might allow continuous access with the adjacent general-purpose lanes or restrict access only to designated locations. Preferential lanes might be operated in a constant direction or operated as reversible lanes. Some reversible preferential lanes on a divided highway might be operated counter-flow to the direction of traffic on the immediately adjacent general-purpose lanes.
- 03 Preferential lanes might be operated on a 24-hour basis, for extended periods of the day, during peak travel periods only, during special events, or during other activities.
- 04 Open-road tolling lanes and toll plaza lanes that segregate traffic based on payment method are not considered preferential lanes. Chapter 2F contains information regarding signing of open-road tolling lanes and toll plaza lanes.
- 05 Managed lanes typically restrict access with the adjacent general-purpose lanes to designated locations only.
- 06 Under certain operational strategies, such as the occupancy requirement of an HOV lane changing in response to actual congestion levels, a managed lane is a special type of preferential lane (see Sections 2G.03 through 2G.07).
- 07 A managed lane operated on a real-time basis in response to changing conditions might be operated as an HOV lane for a period of time as needed to manage congestion levels.
- 08 Sections 2G.16 through 2G.18 contain additional information regarding signs for managed lanes that use tolling or pricing as a management strategy.
- 09 Section 9B.04 contains information regarding Preferential Lane signs for bike lanes.

Section 2G.02 Sizes of Preferential and Managed Lane Signs

Standard:

- 01 **Except as provided in Section 2A.11, the sizes of preferential and managed lane signs that have standardized designs shall be as shown in Table 2G-1 and the “Sign Designs and Markings Manual” (SDMM) (see Section 1A.11).**

Support:

- 02 Section 2A.11 contains information regarding the applicability of the various columns in Table 2G-1.
- Option:
- 03 Signs larger than those shown in Table 2G-1 may be used (see Section 2A.11).

Section 2G.03 Regulatory Signs for Preferential Lanes – General

Standard:

- 01 **When a preferential lane is established, the Preferential Lane regulatory signs (see Figure 2G-1) and pavement markings (see Chapter 3D) for these lanes shall be used to advise road users.**

Support:

- 02 Preferential Lane (R3-10 series through R3-15 series) regulatory signs consist of several different general types of regulatory signs as follows (see Figure 2G-1):

- A. Vehicle Occupancy Definition signs define the vehicle occupancy requirements applicable to an HOV lane (such as “2 OR MORE PERSONS PER VEHICLE”) or types of vehicles not meeting the minimum occupancy requirement (such as motorcycles or ILEVs) that are allowed to use an HOV lane (see Section 2G.04).
- B. Periods of Operation signs notify road users of the days and hours during which the preferential restrictions are in effect (see Section 2G.05).
- C. Preferential Lane Advance signs notify road users that a preferential lane restriction begins ahead (see Section 2G.06).
- D. Preferential Lane Ends signs notify users of the termination point of the preferential lane restrictions (see Section 2G.07).

Standard:

- 03 **Regulatory signs applicable only to a preferential lane shall be distinguished from regulatory signs applicable to general-purpose lanes by the inclusion of the applicable symbol(s) and/or word(s) (see Figure 2G-1).**

Support:

- 04 The symbol and word message displayed on a particular Preferential Lane regulatory sign will vary based on the specific type of allowed traffic and on other related operational constraints that have been established for a particular lane, such as an HOV lane, a bus lane, or a taxi lane.

Option:

- 05 Changeable message signs may supplement, substitute for, or be incorporated into static Preferential Lane regulatory signs where travel conditions change or where multiple types of operational strategies (such as variable occupancy requirements or vehicle types) are used and varied throughout the day or week, or on a real-time basis, to manage the use of, control of, or access to preferential lanes.

Support:

- 06 Figure 2G-1 illustrates examples of changeable messages incorporated into static Preferential Lane regulatory signs.

Standard:

- 07 **When changeable message signs (see Chapter 2L) are used as regulatory signs for preferential lanes, they shall be the required sign size and shall display the required letter height and legend format that corresponds to the type of roadway facility and design speed.**

Guidance:

- 08 *When Preferential Lane regulatory signs are used on conventional roads, the decision regarding whether to use a post-mounted or overhead version of a particular type of sign should be based on an engineering study that considers the available space, the existing signs for the adjacent general-purpose traffic lanes, roadway and traffic characteristics, the proximity to existing overhead signs, the ability to install overhead signs, and any other unique local factors.*

- 09 *If overhead regulatory signs applicable only to a preferential lane are located in approximately the same longitudinal position along the highway as overhead signs applicable only to the general-purpose lanes, the signs for the preferential lane should be separated laterally from the signs for the general-purpose lanes to the maximum extent practical to minimize conflicting information, while maintaining their visual relationship to the lanes below necessitated by specific legend or arrows indicating lane assignment.*

Standard:

- 10 **If used, overhead Preferential Lane (R3-13 series, R3-14 series, and R3-15 series) regulatory signs shall be installed on the side of the roadway where the entrance to the preferential lane is located and any appropriate adjustments shall be made to the sign message.**

Option:

- 11 Where a median of sufficient width is available, the R3-13 series and R3-15 series signs may be post-mounted.

Support:

- 12 The sizes for Preferential Lane regulatory signs will differ to reflect the design speeds for each type of roadway facility. Table 2G-1 provides sizes for each type of roadway facility.

Table 2G-1. Managed and Preferential Lanes Sign and Plaque Minimum Sizes
(Sheet 1 of 2)

Sign or Plaque	Sign Designation	Section	Conventional Road		Expressway	Freeway	Oversized
			Single Lane	Multi-Lane			
Preferential Lane Vehicle Occupancy Definition (post-mounted)	R3-10,10a	2G.04	30 x 42		36 x 60	78 x 96	78 x 96
Preferential Lane Periods of Operation (post-mounted)	R3-11 series	2G.05	30 x 42		36 x 60	78 x 96	78 x 96
Motorcycles Allowed (plaque)	R3-11P	2G.03	30 x 15		36 x 18	78 x 36	78 x 36
Preferential Lane Ahead or Ends (post-mounted)	R3-12 series	2G.06	30 x 42		36 x 60	48 x 84	48 x 84
Preferential Lane Vehicle Occupancy Definition (overhead)	R3-13,13a	2G.04	66 x 36		84 x 48	144 x 78	144 x 78
HOV Lane Periods of Operation (overhead)	R3-14, 14a, 14b	2G.05	72 x 60		96 x 72	144 x 108	144 x 108
Preferential Lane Periods of Operation (overhead)	R3-14c	2G.05	90 x 60		108 x 72	156 x 102	168 x 102
HOV Lane Ahead (overhead)	R3-15	2G.06	66 x 36		84 x 48	102 x 60	102 x 60
HOV Lane Begins XX Miles (overhead)	R3-15a	2G.06	78 x 42		102 x 54	132 x 72	132 x 72
HOV Lane Ends (overhead)	R3-15b, 15c	2G.07	66 x 36		84 x 48	102 x 60	102 x 60
Preferential Lane Ahead or Ends (overhead)	R3-15d, 15e	2G.07	42 x 36		54 x 48	72 x 60	72 x 60
Priced Managed Lane Vehicle Occupancy Definition (post-mounted)	R3-40	2G.17	—		54 x 66		66 x 78
Priced Managed Lane Ends (post-mounted)	R3-42, 42b	2G.17	—		48 x 60		60 x 78
Priced Managed Lane Ends Advance (post-mounted)	R3-42a, 42c	2G.17	—		48 x 66		60 x 84
Priced Managed Lane Vehicle Occupancy Definition	R3-43	2G.17	—		138 x 66		—
Priced Managed Lane Entry Point (overhead)	R3-44	2G.17	—		90 x 84		—
Priced Managed Lane Entry Point (overhead)	R3-44a	2G.17	—		132 x 84		—
Priced Managed Lane Ends (overhead)	R3-45	2G.17	—		90 x 66		—

Table 2G-1. Managed and Preferential Lanes Sign and Plaque Minimum Sizes
(Sheet 2 of 2)

Sign or Plaque	Sign Designation	Section	Conventional Road		Expressway	Freeway	Oversized
			Single Lane	Multi-Lane			
Priced Managed Lane Ends (overhead)	R3-45a	2G.17	—	—	114 x 66	—	—
Priced Managed Lane Toll Rate	R3-48	2G.17	—	—	Varies	—	—
Priced Managed Lane Toll Rate	R3-48a	2G.17	—	—	Varies	—	—
HOV (plaque)	W16-11P	2G.09	24 x 12	—	30 x 18	—	30 x 18
Preferential Lane Entrance Gore	E8-1	2G.10	—	—	48 x 96	—	—
Preferential Lane Intermediate Entrance Gore	E8-1a	2G.10	—	—	48 x 84	—	—
Preferential Lane Entrance Direction (overhead)	E8-2	2G.11	—	—	222 x 72	—	—
Preferential Lane Entrance Direction (post-mounted)	E8-2a	2G.11	—	—	186 x 108	—	—
Preferential Lane Entrance Advance	E8-3	2G.11	—	—	186 x 96	—	—
Preferential Lane Direct Exit Gore	E8-4	2G.15	—	—	60 x 78	—	—
Preferential Lane Intermediate Egress Direction	E8-5	2G.13	—	—	Varies x 90	—	—
Preferential Lane Intermediate Egress Advance	E8-6	2G.13	—	—	Varies x 84	—	—

Notes:

1. Larger signs may be used when appropriate.
2. Dimensions in inches are shown as width x height.
3. Section 2A.11 contains information regarding the applicability of the various columns in Table 2G-1.

Guidance:

- 13 *The edges of Preferential Lane regulatory signs that are post-mounted on a median barrier should not project beyond the outer edges of the barrier, including in areas where lateral clearance is limited.*

Option:

- 14 Where lateral clearance is limited, Preferential Lane regulatory signs that are post-mounted on a median barrier and that are 72 inches or less in width may be skewed up to 45 degrees in order to fit within the barrier width or may be mounted higher, such that the vertical clearance to the bottom of the sign, light fixture, or structural support, whichever is lowest, is not less than 14 feet above any portion of the pavement and shoulders.

Standard:

- 15 **Where lateral clearance is limited, Preferential Lane regulatory signs that are post-mounted on a median barrier and that are wider than 72 inches shall be mounted with a vertical clearance that complies with the provisions of Section 2A.18 for overhead mounting.**

Figure 2G-1. Preferential Lane Regulatory Signs and Plaques (Sheet 1 of 2)

POST-MOUNTED PREFERENTIAL LANE SIGNS

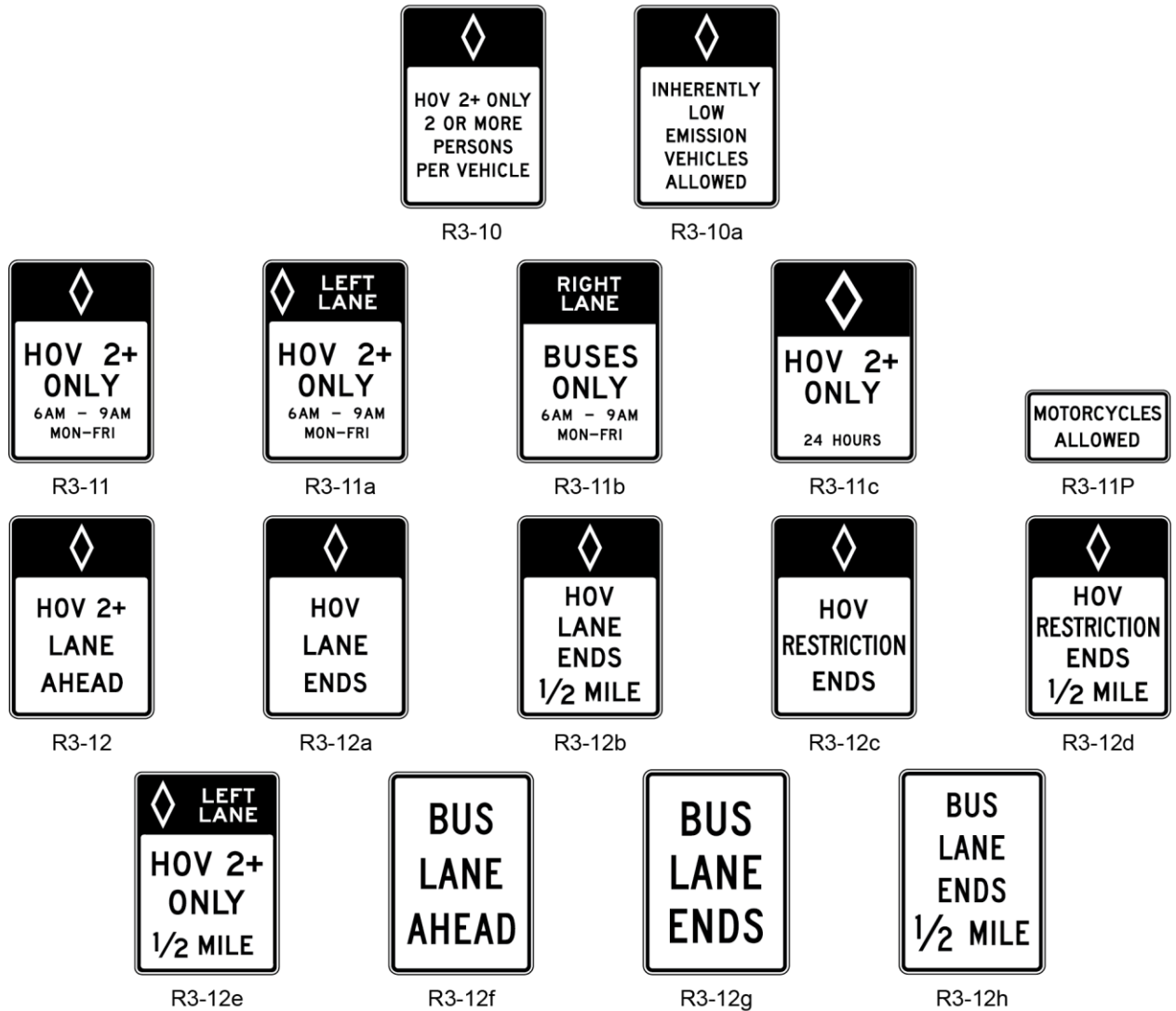

Notes:

1. The minimum vehicle occupancy requirement may vary for each facility (such as 2+, 3+, 4+).
2. The occupancy requirement may be added to the first line of the R3-12a, R3-12b, R3-12c, and R3-12d signs.
3. Some of the legends shown on these signs are for example purposes only. The specific legend for a particular application should be based upon local conditions, ordinances, and State statutes.

Guidance:

- 16 *On conventional roadways, Preferential Lane regulatory sign spacing should be determined by engineering judgment based on speed, block length, distances from adjacent intersections, and other site-specific considerations.*

Support:

- 17 Sections 2G.04 and 2G.05 contain provisions regarding the placement of Preferential Lane regulatory signs on freeways and expressways.

Standard:

- 18 **The signs illustrated in Figure 2G-1 that incorporate the diamond symbol shall be used exclusively with preferential lanes for high-occupancy vehicles to indicate the particular occupancy requirement and time restrictions applying to that lane. The signs illustrated in Figure 2G-1 that do not have a diamond symbol shall be used with preferential lanes that are not HOV lanes, but are designated for use by other types of vehicles (such as bus and/or taxi use).**

Figure 2G-1. Preferential Lane Regulatory Signs and Plaques (Sheet 2 of 2)

OVERHEAD PREFERENTIAL LANE SIGNS

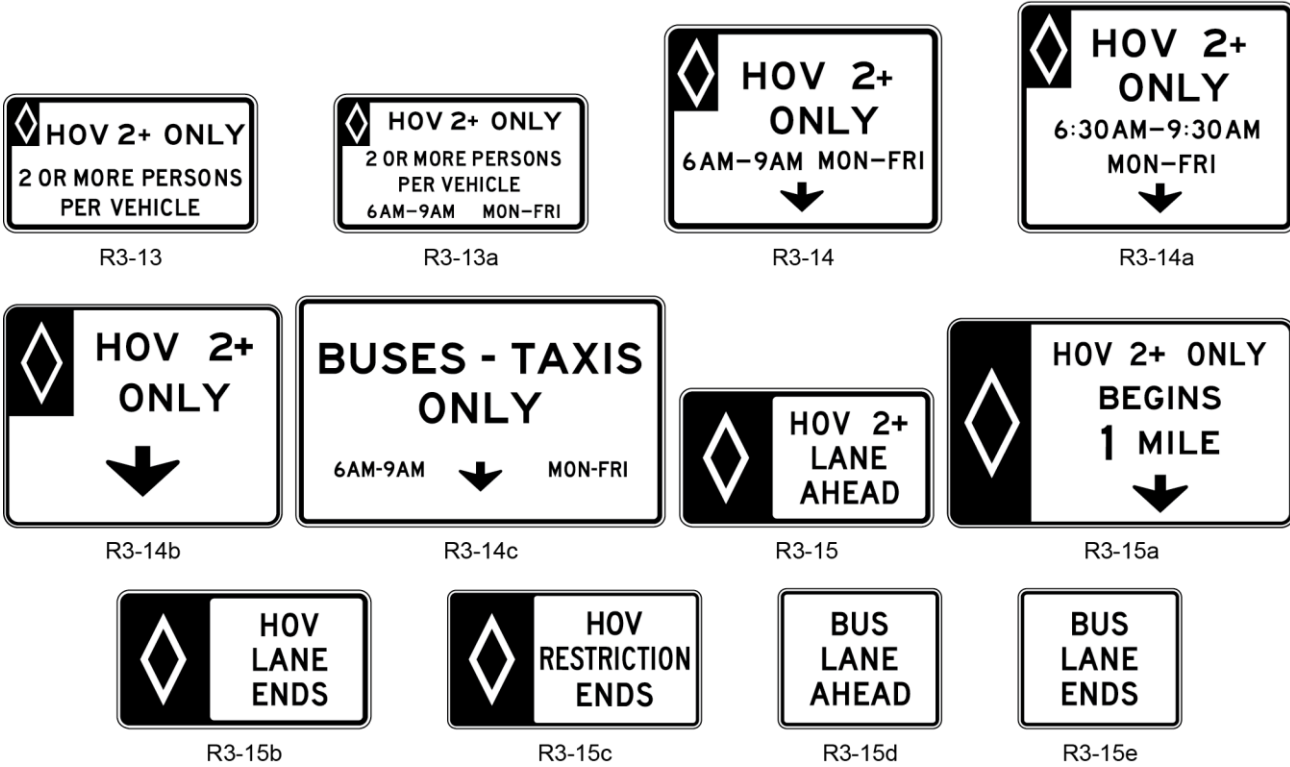

A lane-use control signal may be incorporated into an overhead preferential lane regulatory sign to indicate the status of a reversible operation as shown in the following example:

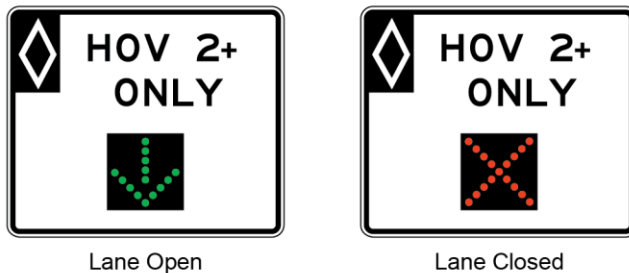

Notes:

1. The minimum vehicle occupancy requirement may vary for each facility (such as 2+, 3+, 4+).
2. The occupancy requirement may be added to the first line of the R3-15b and R3-15c signs.
3. Some of the legends shown on these signs are for example purposes only. The specific legend for a particular application should be based upon local conditions, ordinances, and State statutes.
4. Where sufficient median width is available, the R3-13 series and R3-15 series signs may be post-mounted.

Option:

19 Agencies may select from either the HOV abbreviation or the diamond symbol, or use both, to reference the HOV lane designation.

Standard:

20 **When the diamond symbol (or HOV abbreviation) is used without text on the post-mounted Preferential Lane (R3-10 series, R3-11 series, and R3-12 series) regulatory signs, it shall be centered on the top line of the sign. When the diamond symbol (or HOV abbreviation) is used with associated text on the post-mounted Preferential Lane (R3-10 series, R3-11 series, and R3-12 series) regulatory signs, it shall appear to the left of the associated text. When the diamond symbol is used on the overhead Preferential Lane (R3-13, R3-13a, R3-14, R3-14a, and R3-14b) regulatory signs, it shall**

appear in the top left quadrant. The diamond symbol for the R3-15, R3-15a, R3-15b, and R3-15c signs shall appear on the left side of the sign. The diamond symbol shall not be used on the bus, taxi, or bicycle Preferential Lane signs.

- 21 **Vehicle Occupancy Definition, Periods of Operation, and Preferential Lane Advance regulatory signs for HOV lanes shall display the minimum allowable vehicle occupancy requirement established for each HOV lane, displayed immediately after the word message HOV or the diamond symbol.**

Support:

- 22 The agencies that own and operate HOV lanes have the authority and responsibility to determine how they are operated and the minimum occupancy requirements. Information about federal requirements for certain types of vehicles not meeting the minimum occupancy requirement to be eligible to use HOV lanes that receive Federal-aid program funding and about requirements associated with proposed significant changes to the operation of an existing HOV lane and certain vehicles are contained in the “Federal-Aid Highway Program Guidance on High Occupancy Vehicle (HOV) Lanes” (see Section 1A.11).

Standard:

- 23 **The provisions of Sections 2G.03 through 2G.07 regarding regulatory signs for Preferential lanes shall apply to managed lanes operated at all times or at certain times by varying vehicle occupancy requirements (HOV) or by using vehicle type restrictions as a congestion management strategy. Such managed lanes shall use changeable message signs or changeable message elements within static signs to display the appropriate regulatory sign messages only when they are in effect.**

- 24 **When certain types of vehicles (such as trucks) are prohibited from using a managed lane or when a managed lane is restricted to use by only certain types of vehicles during certain operational strategies, regulatory signs or regulatory panels within the appropriate guide signs that include changeable message elements shall be used to display the open/closed status of the managed lane for such vehicle types.**

- 25 **When the vehicle occupancy required for use of an HOV lane is varied as a part of a managed lane operational strategy, regulatory signs that include changeable message elements shall be used to display the required vehicle occupancy in effect.**

Support:

- 26 See Section 2G.17 for regulatory signs for managed lanes that use tolling or pricing as a congestion management strategy, either exclusively or with other management strategies.

- 27 Figures 2G-2 and 2G-3 illustrate the use of regulatory signs for the beginning, along the length, and at the end of contiguous or buffer-separated preferential lanes that provide continuous access with the adjacent general-purpose lanes.

Section 2G.04 Preferential Lane Vehicle Occupancy Definition Regulatory Signs (R3-10 Series and R3-13 Series)

Standard:

- 01 **The R3-10, R3-13, and R3-13a Vehicle Occupancy Definition signs (see Figure 2G-1) shall be used where agencies determine that it is appropriate to provide a sign that defines the minimum occupancy of vehicles that are allowed to use an HOV lane.**

Guidance:

- 02 *The Inherently Low Emission Vehicle (ILEV) (R3-10a) sign (see Figure 2G-1) should be used when it is permissible for a properly labeled and certified ILEV, regardless of the number of occupants, to use an HOV lane. When used, the ILEV signs should be post-mounted in advance of and at intervals along the HOV lane based upon engineering judgment and the placement of other Preferential Lane regulatory signs. The R3-10a sign is only applicable to HOV lanes and should not to be used with other preferential lane applications.*

Support:

- 03 ILEVs are defined by the Environmental Protection Agency (EPA) as vehicles having no fuel vapor (hydrocarbon) emissions and are certified by the EPA as meeting the emissions standards and requirements specified in 40 CFR 88-311-93 and 40 CFR 88.312-93(c).

Guidance:

- 04 *The legend format of the R3-10 and R3-13 signs should have the following sequence:*
- A. *Top Line: "HOV 2+ ONLY" (or 3+ or 4+ if appropriate)*
 - B. *Bottom Lines: "2 OR MORE PERSONS PER VEHICLE" (or 3 or 4 if appropriate)*

- 05 *The legend format of the R3-13a sign should have the following sequence:*
- A. *Top Line: "HOV 2+ ONLY" (or 3+ or 4+ if appropriate)*
 - B. *Middle Lines: "2 OR MORE PERSONS PER VEHICLE" (or 3 or 4 if appropriate)*
 - C. *Bottom Lines: Times and days the occupancy restriction is in effect*

Support:

- 06 Section 2G.17 contains information regarding the legends of Vehicle Occupancy Definition signs for a priced managed lane that has an occupancy requirement for non-toll travel.

Standard:

- 07 **For barrier- or buffer-separated or contiguous preferential lanes where access between the preferential and general-purpose lanes is restricted to designated locations, an overhead Vehicle Occupancy Definition (R3-13 or R3-13a) sign shall be installed at least 1/2 mile in advance of the beginning of or initial entry point to an HOV lane. These signs shall only be displayed in advance of the beginning of or initial entry point to HOV lanes.**

Option:

- 08 For barrier-separated HOV lanes, the sequence of a post-mounted Periods of Operation (R3-11a) sign followed by a post-mounted Vehicle Occupancy Definition (R3-10) sign may be located at intervals of approximately 1/2 mile along the length of the HOV lane, at intermediate entry points, and at designated enforcement areas as defined by the operating agency.

Standard:

- 09 **For buffer-separated or contiguous HOV lanes where access is restricted to designated locations, the sequence of a post-mounted Periods of Operation (R3-11a) sign followed by a post-mounted Vehicle Occupancy Definition (R3-10) sign shall be located at intervals not greater than 1/2 mile along the length of the access-restricted HOV lane, at designated gaps where vehicles are allowed to legally access the access-restricted HOV lane, and within designated enforcement areas as defined by the operating agency.**

- 10 **For buffer-separated or contiguous HOV lanes where continuous access with the adjacent general-purpose lanes is provided, the sequence of a post-mounted Periods of Operation (R3-11a) sign followed by a post-mounted Vehicle Occupancy Definition (R3-10) sign, and ILEV (R3-10a) signs if appropriate, shall be located at intervals not greater than 1/2 mile along the length of the HOV lane.**

Guidance:

- 11 *The signs within each Preferential Lane regulatory sign sequence should be separated by a minimum distance of 800 feet and a maximum distance of 1,000 feet.*

Standard:

- 12 **For all types of direct access ramps that provide access to or lead to HOV lanes, a post-mounted Vehicle Occupancy Definition (R3-10) sign, and an ILEV (R3-10a) sign if appropriate, shall be used at the beginning or initial entry point for the direct access.**

Section 2G.05 Preferential Lane Periods of Operation Regulatory Signs (R3-11 Series and R3-14 Series)

Guidance:

- 01 *The sizes of post-mounted Periods of Operation (R3-11 series) signs should remain consistent to accommodate any manual addition or removal of a single line of text for each sign.*

Support:

- 02 Consistent sign sizes are beneficial for agencies when ordering sign materials, as well as when making text changes to existing signs if changes occur to operating times or occupancy restrictions in the future. For example, the R3-11c sign has space for one line located below "24 HOURS" if an agency determines that it

is appropriate to display additional information (such as “MON – FRI”), yet the R3-11c sign has the same dimensions as the other R3-11 series signs.

Standard:

- 03 **When used, the post-mounted Periods of Operation (R3-11 series) signs shall be located adjacent to the preferential lane, and the overhead Periods of Operation (R3-14 series) signs shall be mounted directly over the lane.**
- 04 **The legend format of the post-mounted Periods of Operation (R3-11 series) signs shall have the following sequence:**
- A. **Top Lines: Lanes applicable, such as “RIGHT LANE” or “2 RIGHT LANES” or “THIS LANE”**
 - B. **Middle Lines: Eligible uses, such as “HOV 2+ ONLY” (or 3+ or 4+ if appropriate) or “BUSES ONLY” or other applicable uses or eligible turning movements**
 - C. **Bottom Lines: Applicable times and days, such as “7 AM – 9 AM” or “6:30 AM – 9:30 AM, MON-FRI”**
- 05 **The legend format of the overhead Periods of Operation (R3-14 series) signs shall have the following sequence:**
- A. **Top Line: Eligible uses, such as “HOV 2+ ONLY” (or 3+ or 4+ if appropriate) or “BUSES ONLY” or other applicable uses or eligible turning movements**
 - B. **Bottom Lines: Applicable times and days, with the time and day placed above the down arrow, such as “7 AM – 9 AM” or “6:30 AM – 9:30 AM, MON-FRI” (When the operating periods exceed the available line width, the hours and days of the week shall be stacked as shown for the R3-14a sign in Figure 2G-1.)**
- 06 **For preferential lanes that are in effect on a full-time basis, either the full-time Periods of Operation (R3-11c and R3-14b) signs shall be used, or the legends of the part-time Periods of Operations (R3-11, R3-11a, R3-11b, R3-14, R3-14a) signs shall be modified to display the legend 24 HOURS.**
- 07 **The full-time Periods of Operation (R3-14b) sign shall not be used where the preferential lane is in effect only on a part-time basis.**
- Option:
- 08 Where additional movements are permitted from a preferential lane on an approach to an intersection, the format and words used in the legend in the middle lines on the post-mounted Periods of Operation (R3-11 series) signs and on the top line of the overhead Periods of Operation (R3-14 series) signs may be modified to accommodate the permitted movements (such as “HOV 2+ AND RIGHT TURNS ONLY”).
- 09 A MOTORCYCLES ALLOWED (R3-11P) plaque may be used where motorcycles, regardless of the number of occupants, are allowed to use an HOV lane.
- Standard:**
- 10 **If used, the MOTORCYCLES ALLOWED plaque shall be mounted below a post-mounted Preferential Lane Periods of Operation (R3-11, R3-11a, or R3-11c) sign.**
- 11 **For all barrier- or buffer-separated or contiguous preferential lanes where access is restricted to designated locations, an overhead Periods of Operation (R3-14 series) sign shall be used at the beginning or initial entry point, and at any intermediate entry points or gaps in the barrier where vehicles are allowed to legally access the access-restricted preferential lanes. For all barrier-separated and buffer-separated preferential lanes, post-mounted Periods of Operation (R3-11 series) signs shall be used only as a supplement to the overhead signs at the beginning or initial entry point, or at any intermediate entry points or gaps in the barrier or buffer.**
- 12 **For buffer-separated or contiguous preferential lanes where continuous access with the adjacent general-purpose lanes is provided, including those where a preferential lane is added to the roadway (see Figure 2G-2 for HOV lanes) and those where a general-purpose lane transitions into a preferential lane (see Figure 2G-3 for HOV lanes), an overhead Periods of Operation (R3-14 series) sign shall be used at the beginning or initial entry point of the preferential lane.**

Figure 2G-2. Example of Signing for an Added Continuous-Access Contiguous or Buffer-Separated HOV Lane

Notes:

1. The minimum vehicle occupancy requirement and hours of operation on the sign may vary for each facility.
2. See Chapter 3D for pavement markings.
3. Warning signs are not shown.
4. Applicable to part-time or full-time HOV restriction.
5. This roadway condition indicates the HOV lane will merge with the general purpose lanes upon termination.
6. Sets of R3-10 and R3-11a signs should be placed following entrance ramps and at 1/2-mile intervals along the HOV lane.

* Where the median width is insufficient, post-mounted designs (R3-10, R3-11, and R3-12 series) may be used.

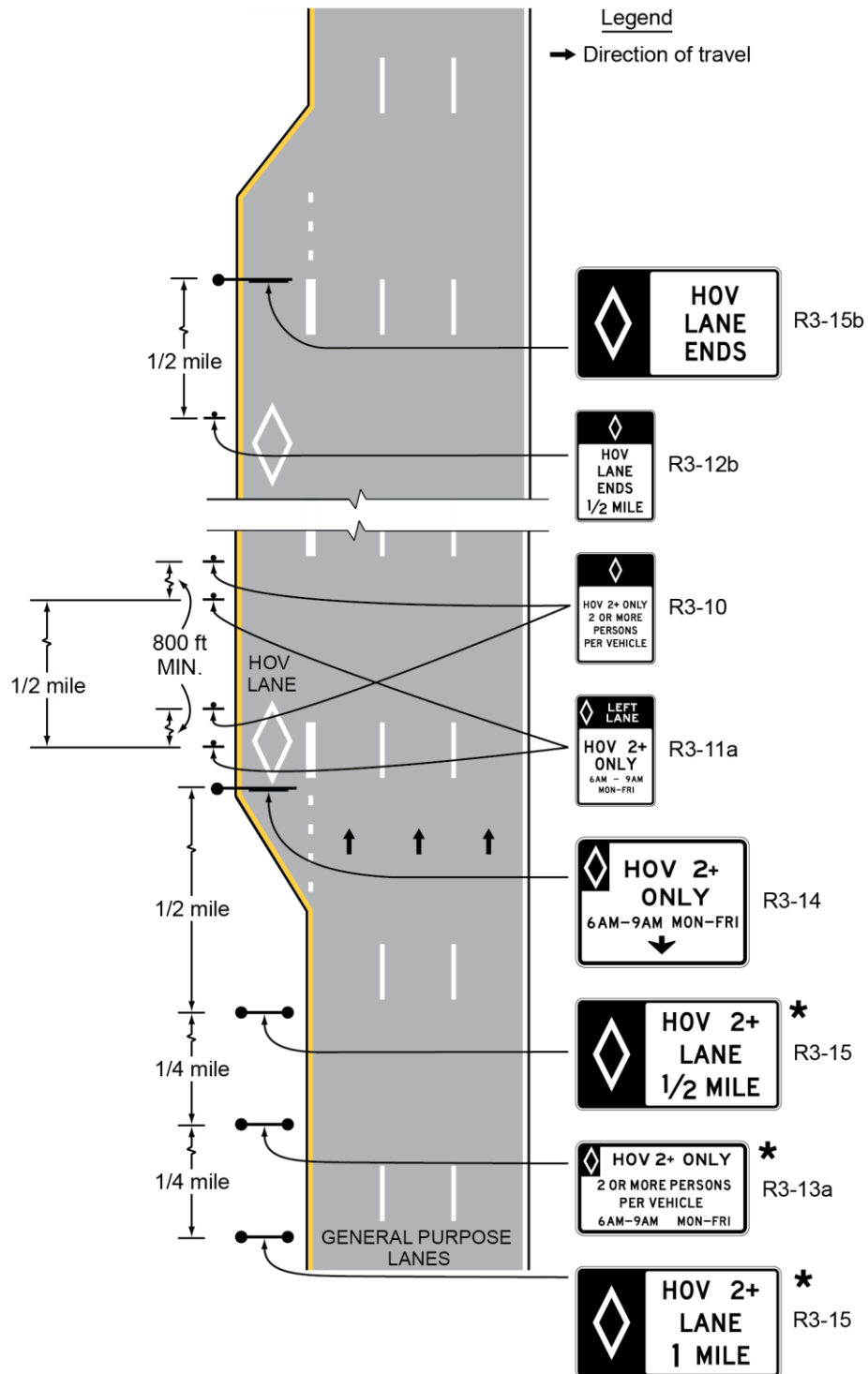
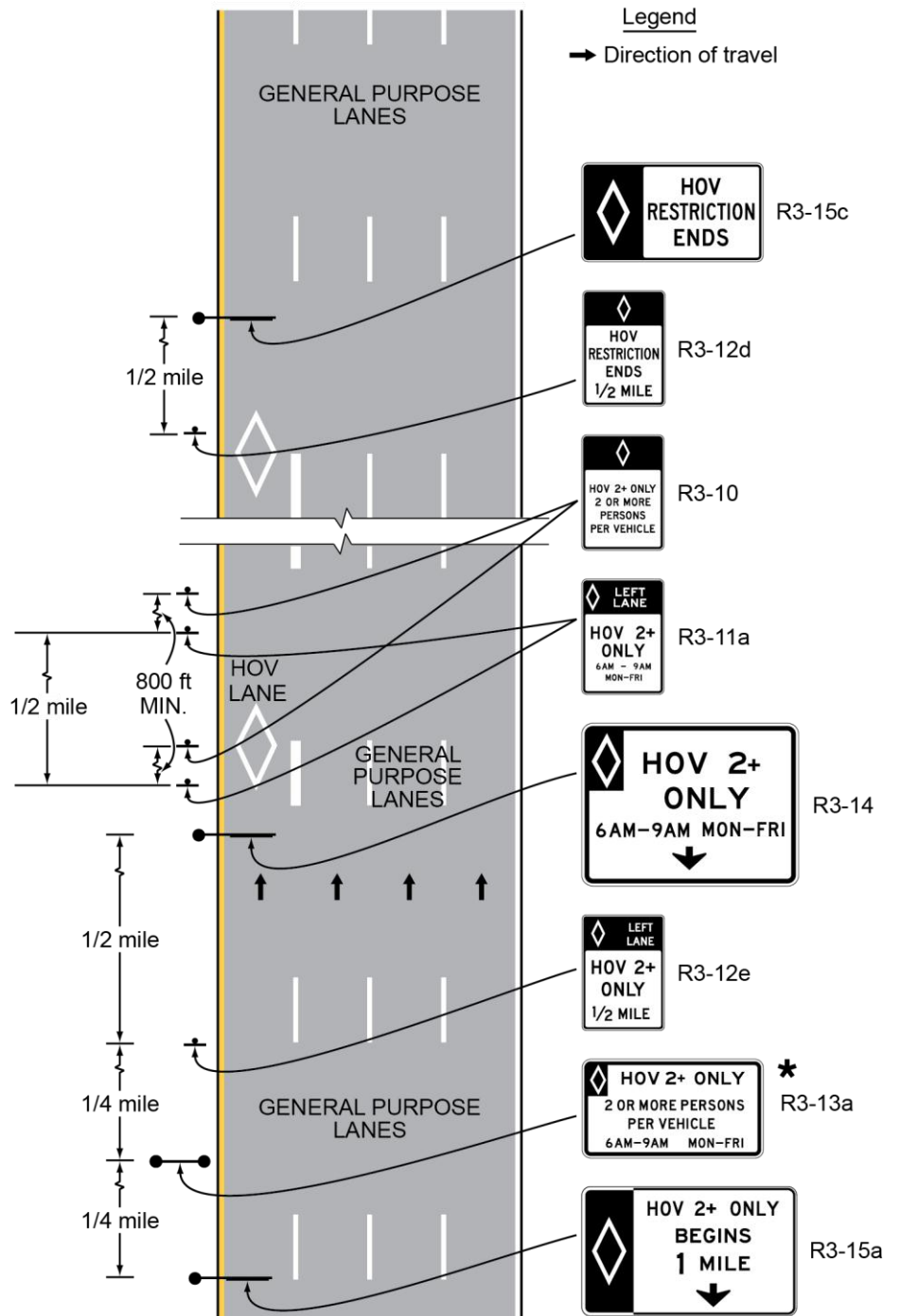

Figure 2G-3. Example of Signing for a General-Purpose Lane that Becomes a Continuous-Access Contiguous or Buffer-Separated HOV Lane

Notes:

1. The minimum vehicle occupancy requirement and hours of operation on the sign may vary for each facility.
2. See Chapter 3D for pavement markings.
3. Applicable to part-time or full-time HOV restriction.
4. This roadway condition indicates the HOV lane will become a general purpose lane upon termination of the restriction.
5. Sets of R3-10 and R3-11a signs should be placed following entrance ramps and at 1/2-mile intervals along the HOV lane.
6. This signing scheme can also be used for an HOV lane on the right-hand side of the roadway.

* Where the median width is insufficient, this sign may be mounted overhead.



Guidance:

- 13 *Overhead (R3-14 series) or post-mounted (R3-11 series) Periods of Operation signs should be installed at periodic intervals along the length of a contiguous or buffer-separated preferential lane where continuous access with the adjacent general-purpose lanes is provided.*

Option:

- 14 Additional overhead (R3-14 series) or post-mounted (R3-11 series) Periods of Operation signs may be provided along the length of any type of preferential lane.
- 15 On conventional roads, the overhead Periods of Operation (R3-14 series) signs may be installed at the beginning or entry points and/or at intermediate points along preferential lanes in any geometric configuration.

Standard:

- 16 **For all types of direct access ramps that provide access to or lead to preferential lanes, a post-mounted Periods of Operation (R3-11 series) sign shall be used at the beginning or initial entry point of the direct access ramp.**

Option:

- 17 For direct access ramps to preferential lanes, an overhead Periods of Operation (R3-14 series) sign may be used at the beginning or initial entry point to supplement the required post-mounted signs.
- 18 Lane-use control signals (see Chapter 4M) may be used at access points to preferential lanes to indicate that a ramp or access roadway leading to the preferential lane or facility, or one or more specific lanes of the facility, are open or closed (see Figure 2G-13).

Section 2G.06 Preferential Lane Advance Regulatory Signs (R3-12, R3-12e, R3-12f, R3-15, R3-15a, R3-15d)

Guidance:

- 01 *The Preferential Lane Advance (R3-12, R3-12f, R3-15, and R3-15d) signs should be used for advance notification of a barrier-separated, buffer-separated, or contiguous preferential lane that is added to the general-purpose lanes (see Figure 2G-2).*
- 02 *The Preferential Lane Advance (R3-12e and R3-15a) signs should be used for advance notification of a general-purpose lane that becomes a preferential lane (see Figure 2G-3).*

Option:

- 03 The legends on the R3-12f and R3-15d signs may be modified to suit the type of preferential lane.

Guidance:

- 04 *On conventional roads, for general-purpose lanes that become preferential lanes, a post-mounted (R3-12e) or overhead (R3-15a) Preferential Lane Advance sign should be installed in advance of the beginning of or initial entry point to the preferential lane at a distance determined by engineering judgment based on speed, traffic characteristics, and other site-specific considerations. The distance selected should provide adequate opportunity for ineligible vehicles to vacate the lane prior to the beginning of the restriction.*
- 05 *On freeways and expressways, for general-purpose lanes that become preferential lanes, an overhead Preferential Lane Advance (R3-15a) sign should be installed at least 1 mile in advance of the beginning of the preferential lane restriction.*

Option:

- 06 Additional post-mounted or overhead Preferential Lane Advance signs may be placed farther in advance of or closer to the beginning or initial entry points to a preferential lane.

Section 2G.07 Preferential Lane Ends Regulatory Signs (R3-12a, R3-12b, R3-12c, R3-12d, R3-12g, R3-12h, R3-15b, R3-15c, R3-15e)

Standard:

- 01 **A post-mounted Preferential Lane Ends (R3-12b or R3-12h) sign shall be installed at least 1/2 mile in advance of the termination of a preferential lane.**

02 **Except as provided in Paragraph 6, a post-mounted Preferential Lane Ends (R3-12a or R3-12g) sign shall be installed at the point where a preferential lane and restriction end and traffic must merge into the general-purpose lanes.**

03 **A post-mounted Preferential Lane Ends (R3-12d) sign shall be installed at least 1/2 mile in advance of the point where a preferential lane restriction ends and the lane becomes a general-purpose lane.**

04 **Except as provided in Paragraph 7, a post-mounted Preferential Lane Ends (R3-12c) sign shall be installed at the point where a preferential lane restriction ends and the lane becomes a general-purpose lane.**

Option:

05 The legends on the R3-12g and R3-15e signs may be modified to suit the type of preferential lane.

06 An overhead Preferential Lane Ends (R3-15b or R3-15e) sign may be installed instead of or in addition to a post-mounted R3-12a or R3-12g sign at the point where a preferential lane and restriction ends and traffic must merge into the general-purpose lanes.

07 An overhead Preferential Lane Ends (R3-15c) sign may be installed instead of or in addition to a post-mounted R3-12c sign at the point where the preferential lane restriction ends and the lane becomes a general-purpose lane.

Section 2G.08 Warning Signs on Median Barriers for Preferential Lanes

Option:

01 When a warning sign applicable only to a preferential lane is installed on a median barrier with limited lateral clearance to the adjacent travel lanes or shoulders, the warning sign may have a vertical rectangular shape. For a High Occupancy Vehicle lane, such signs may be used instead of using the HOV Plaque (W16-11P) (see Section 2G.09) with a standard diamond-shaped warning sign.

Standard:

02 **When a vertical rectangular-shaped warning sign applicable only to a preferential lane is installed on a median barrier, the top portion of the sign shall be comprised of a white symbol or legend denoting the type of preferential lane (such as the diamond symbol for HOV or the legend BUS LANE) on a black background with a white border, and the bottom portion of the sign shall be comprised of the standard word message or symbol of the standard warning sign as a black legend on a yellow background with a black border (see Figure 2G-4).**

Guidance:

03 *Where lateral clearance is limited, such as when a post-mounted warning sign applicable only to a preferential lane is installed on a median barrier, the edges of the sign should not project beyond the outer edges of the barrier.*

Option:

04 Where lateral clearance is limited, warning signs applicable only to a preferential lane that are post-mounted on a median barrier and that are 72 inches or less in width may be skewed up to 45 degrees in order to fit within the barrier width or may be mounted higher, such that the vertical clearance to bottom of the sign, light fixture, or its structural support, whichever is lowest, is not less than 14 feet above any portion of the pavement and shoulders.

Standard:

05 **Where lateral clearance is limited, Preferential Lane warning signs that are post-mounted on a median barrier and that are wider than 72 inches shall be mounted with a vertical clearance that complies with the provisions of Section 2A.18 for overhead mounting.**

Figure 2G-4. Examples of Warning Signs and Plaques Applicable Only to Preferential Lanes

A - BARRIER-MOUNTED RECTANGULAR WARNING SIGNS

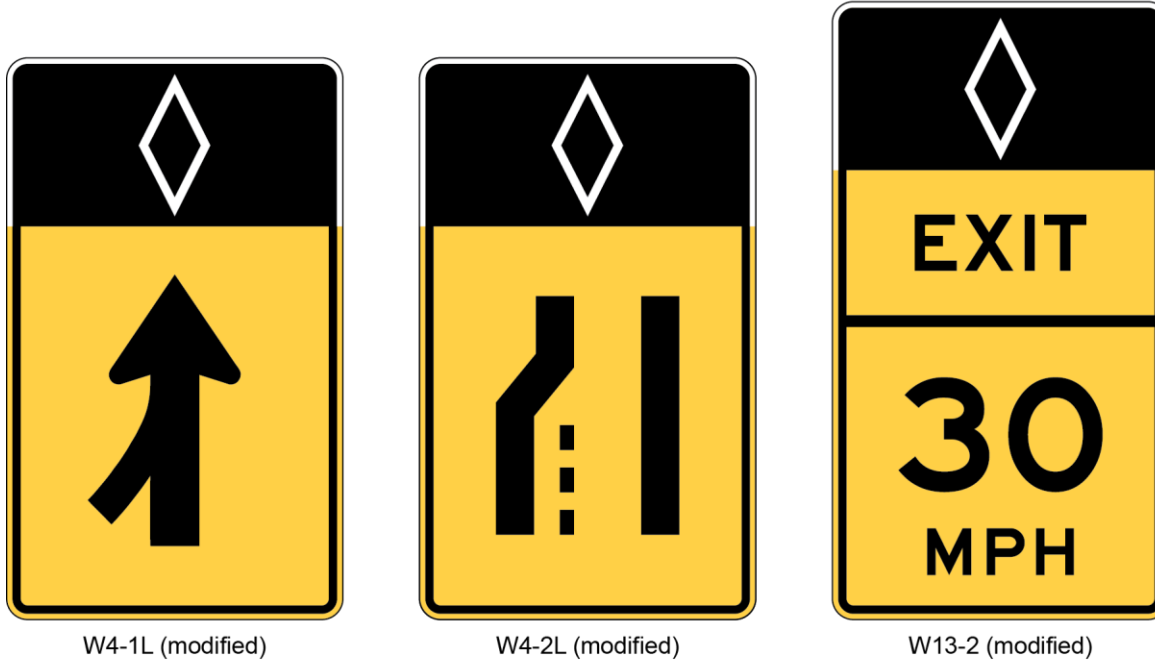

B - WARNING PLAQUE FOR USE ABOVE STANDARD DIAMOND-SHAPED WARNING SIGNS



W16-11P

Note: An HOV lane example (diamond symbol) is illustrated. For other types of preferential lanes, the appropriate symbol or word message (see Section 2G.03) shall be displayed in white on the black background of the top portion of these signs.

Section 2G.09 High-Occupancy Vehicle (HOV) Plaque (W16-11P)

Option:

01 In situations where there is a need to warn drivers in an HOV lane of a specific condition, a HOV (W16-11P) plaque (see Figure 2G-4) may be used above a warning sign. The HOV plaque may be used to differentiate a warning sign specific for HOV lanes when the sign is also visible to traffic on the adjacent general-purpose roadway. Among the warning signs that may be possible applications of the HOV plaque are the Advisory Exit Speed, Added Lane, and Merge signs.

02 The diamond symbol may be used instead of the word message HOV on the W16-11P plaque. When appropriate, the words LANE or ONLY may be used on this plaque.

Support:

03 Section 2G.08 contains information regarding warning signs that can be mounted on barriers for HOV or other types of preferential lanes.

Section 2G.10 Preferential Lane Guide Signs – General

Support:

01 Preferential lanes are used on freeways, expressways, and conventional roads. Except as otherwise provided, Sections 2G.10 through 2G.15 apply only to guide signs for preferential lanes on freeways and expressways.

Guidance:

- 02 *On conventional roads, guide signs applicable only to preferential lanes are ordinarily not needed, but if used they should comply with the provisions for guide signs in Chapter 2D and any principles for Preferential Lane guide signs in Sections 2G.10 through 2G.15 that engineering judgment finds to be appropriate for the conditions.*

Support:

- 03 Consistency in signs and pavement markings for preferential lanes plays a critical role in building public awareness, understanding, and acceptance, and makes enforcement more effective.

- 04 Additional guidance and standards related to the designation, operational considerations, signs, pavement markings, and other considerations for preferential lanes is provided in Sections 2G.03 through 2G.07, and 2G.09, and Chapter 3D.

Guidance:

- 05 *The appropriate combinations of pavement markings and standard overhead and post-mounted regulatory, warning, and guide signs for a specific preferential lane application should be selected based on an engineering study.*

- 06 *If overhead signs applicable only to a preferential lane are located in approximately the same longitudinal position along the highway as overhead signs applicable only to the general-purpose lanes, the signs for the preferential lane should be separated laterally from the signs for the general-purpose lanes to the maximum extent practical to minimize conflicting information.*

- 07 *The Preferential Lane signs should be designed and located to avoid overloading the road user. Based on the importance of the sign, regulatory signs should be given priority over guide signs. The order of priority of guide signs should be Advance Guide, Preferential Lane Entrance Direction, and finally Preferential Lane Exit Destination supplemental guide signs.*

Standard:

- 08 **Signs applicable only to a preferential lane shall be distinguished from signs applicable to general-purpose lanes by the inclusion of the applicable symbol(s) and/or word(s).**

Support:

- 09 The symbol and/or word message that appears on a particular guide sign applicable only to a preferential lane will vary based on the specific type of allowed traffic and on other related operational constraints that have been established for a particular lane, such as an HOV lane, a bus lane, or a taxi lane.

Standard:

- 10 **For HOV lanes, the diamond symbol shall appear on each Advance Guide sign, Preferential Lane Entrance Direction sign, and Preferential Lane Entrance Gore sign, as shown in Figures 2G-5 through 2G-7 for the designated entry and exit points for barrier- and buffer-separated geometric configurations and direct access ramps to or from such lanes. The diamond symbol shall not be used with preferential lanes for other types of traffic, such as bus lanes or taxi lanes.**

- 11 **Signing for an HOV lane that is managed by means of varying the occupancy requirement in response to changing conditions shall also comply with these provisions.**

- 12 **The diamond symbol shall be displayed in the legend of each Preferential Lane guide sign at the designated entry and exit points for all types of HOV lanes (including barrier- and buffer-separated, contiguous, and direct access ramps) in order to alert motorists that there is a minimum allowable vehicle occupancy requirement for vehicles to use the HOV lanes. Guide signs shall not display the occupancy requirement for the preferential lane.**

- 13 **A combination of guide and regulatory signs shall be used in advance of and at the initial entry point and all intermediate entry points from general-purpose lanes or facilities to contiguous, barrier-separated, and buffer-separated preferential lanes where access between the preferential and general-purpose lanes is restricted to designated locations. The regulatory signs shall comply with the provisions of Sections 2G.03 through 2G.07.**

- 14 **Regulatory signs alone shall be used in advance of, at the beginning of, and at periodic intervals along contiguous or buffer-separated preferential lanes that provide continuous access between the**

adjacent general-purpose lanes and the preferential lane (see Figures 2G-2 and 2G-3). The design and placement of the regulatory signs shall comply with the provisions of Sections 2G.03 through 2G.07.

- 15 **Except as otherwise provided in Sections 2G.10 through 2G.13, guide signs applicable to a preferential lane with a vehicle occupancy requirement shall be distinguished from those applicable to general-purpose lanes by displaying the white diamond symbol on a black background at the left-hand edge of these signs.**

Option:

- 16 When post-mounted guide signs applicable only to a preferential lane are installed on a median barrier with limited lateral clearance to the adjacent travel lanes or shoulders, the guide signs may have a vertical rectangular shape.

Standard:

- 17 **When vertical rectangular shaped guide signs applicable only to a preferential lane are installed on a median barrier, the top portion of the signs shall be comprised of the applicable white symbol or white word message that identifies the type of preferential lane (such as the diamond symbol for an HOV lane) on a black background with a white border, and the bottom portion of the sign shall be comprised of the appropriate guide sign legend on a green background with a white border (see Figures 2G-7 2G-11, and 2G-14).**

Guidance:

- 18 *Where lateral clearance is limited, such as when a post-mounted Preferential Lane guide sign is installed on a median barrier, the edges of the sign should not project beyond the outer edges of the barrier.*

Option:

- 19 Where lateral clearance is limited, Preferential Lane guide signs that are 72 inches or less in width may be skewed up to 45 degrees in order to fit within the barrier width or may be mounted higher, such that the vertical clearance to the bottom of the sign, light fixture, or its structural support, whichever is lowest, is not less than 14 feet above any portion of the pavement and shoulders.

Standard:

- 20 **Where lateral clearance is limited, Preferential Lane guide signs that are post-mounted on a median barrier and that are wider than 72 inches shall be mounted with a vertical clearance that complies with the provisions of Section 2A.18 for overhead mounting.**

Option:

- 21 Lane-use control signals (see Chapter 4M) may be used at access points to preferential lanes to indicate that a ramp or access roadway leading to or from the preferential lane or facility, or one or more specific lanes of the facility, are open or closed.

- 22 Changeable message signs may supplement, substitute for, or be incorporated into static guide signs where travel conditions change or where multiple types of operational strategies (such as variable occupancy requirements, vehicle types, or pricing policies) are used and varied throughout the day or week to manage the use of, control of, or access to preferential lanes.

Standard:

- 23 **When changeable message signs (see Chapter 2L) are used as guide signs for preferential lanes, they shall be the required sign size and shall display the required letter height and legend format that corresponds to the type of roadway facility and design speed.**

- 24 **Advance Guide signs, Preferential Lane Entrance Direction signs, and Preferential Lane Entrance Gore signs for the initial entry point and intermediate entry points into a preferential lane from the general-purpose lanes on the same designated route shall not identify the entry point as an exit by using the word “EXIT” on the sign or on a plaque.**

Guidance:

- 25 *Advance Guide signs and Preferential Lane Entrance Direction signs for initial and intermediate entry points into a preferential lane should use the word “ENTRANCE,” such as “HOV LANE ENTRANCE” (see Figures 2G-5 and 2G-6) to convey the fact that vehicles are not leaving the designated route.*

Figure 2G-5. Example of an Overhead Advance Guide Sign for a Preferential Lane Entrance



E8-3

Note: An example of an HOV Lane (diamond symbol) sign is illustrated. For other types of preferential lanes, the appropriate symbol or word message (see Section 2G.03) is displayed in white on the black background of the left-hand portion of this sign.

Figure 2G-6. Examples of Overhead or Post-Mounted Preferential Lane Entrance Direction Signs



E8-2
(overhead only)



E8-2a
(post-mounted only)

A changeable message sign may be incorporated into an overhead preferential lane guide sign to indicate the status of a reversible operation as shown in the following example:



Lane Open



Lane Closed

Note: Examples of HOV Lane (diamond symbol) signs are illustrated. For other types of preferential lanes, the appropriate symbol or word message (see Section 2G.03) is displayed in white on the black background of the top left-hand portion of these signs.

26 *Preferential Lane Entrance Gore signs (see Figure 2G-7) at the initial entry point to a preferential lane should use the word “ENTRANCE.” Preferential Lane Entrance Gore signs at intermediate entry points to a barrier-separated preferential lane where the sign would be located immediately adjacent to and directly viewed by traffic in the preferential lane should not use the word “ENTRANCE.”*

Standard:

27 **When the entry point is on the left-hand side of the general-purpose lanes, a LEFT (E1-5aP) plaque (see Figure 2E-22) shall be added to the top left edge of the Advance Guide and Preferential Lane Entrance Direction signs. The LEFT plaque shall not be used on a preferential lane regulatory sign.**

Figure 2G-7. Entrance Gore Signs for Barrier-Separated Preferential Lanes

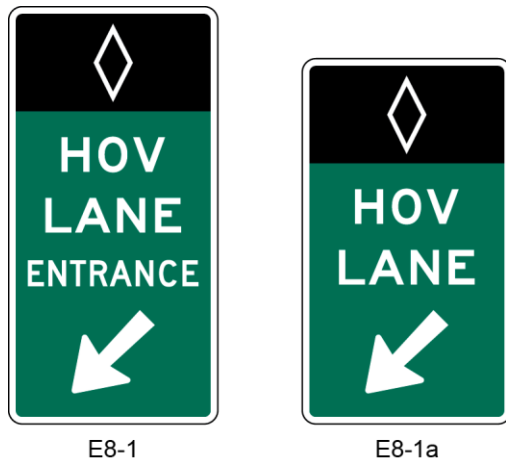

Note: Examples of HOV Lane (diamond symbol) signs are illustrated. For other types of preferential lanes, the appropriate symbol or word message (see Section 2G.03) is displayed in white on the black background of the top portion of these signs.

Section 2G.11 Guide Signs for Initial Entry Points to Preferential Lanes

Standard:

- 01 Except where a buffer-separated or contiguous preferential lane is added or where a general-purpose lane becomes a buffer-separated or contiguous preferential lane, and provides continuous access with the adjacent general-purpose lanes as illustrated in Figures 2G-2 and 2G-3, an Advance Guide sign shall be provided at least 1/2 mile prior to the initial entry point to all types of preferential lanes in any type of geometric configuration. A Preferential Lane Entrance Direction sign shall also be provided at the initial entry point. Advance Guide and Preferential Lane Entrance Direction signs for such entry points shall not include the word “EXIT” (see Section 2G.10).

Guidance:

- 02 An Advance Guide sign should also be installed and located approximately 1 mile in advance of the initial entry point to a preferential lane that restricts access with the adjacent general-purpose lanes to designated locations.

Option:

- 03 An Advance Guide sign may also be installed and located approximately 2 miles in advance of the initial entry point to a preferential lane that restricts access with the adjacent general-purpose lanes to designated locations.

Standard:

- 04 For barrier-separated, buffer-separated, or contiguous preferential lanes where entry is restricted to only designated points, the Advance Guide and Preferential Lane Entrance Direction signs shall be mounted overhead.

Guidance:

- 05 Preferential Lane Exit Destination guide signs, identifying final destination and downstream exit locations accessible from the preferential lane (see Figures 2G-8, 2G-13, 2G-15, and 2G-16), should be installed in advance of the initial entry points to access-restricted preferential lanes (such as barrier- and buffer-separated). These signs should be located based on the priority of the message, the available space, the existing signs on adjacent general-purpose traffic lanes, roadway and traffic characteristics, the proximity to existing overhead signs, the ability to install overhead signs, and other unique local factors.

Standard:

- 06 Advance destination guide signs for preferential lanes shall include an upper section displaying a black legend that includes the type of preferential lane and the word “EXITS,” such as “HOV EXITS,” on a white background. For preferential lanes that incorporate a vehicle occupancy requirement, the white diamond symbol on a black background shall be displayed at the left edge of this upper section (see Figure 2G-8).

Figure 2G-8. Example of Signing for an Entrance to Access-Restricted HOV Lanes

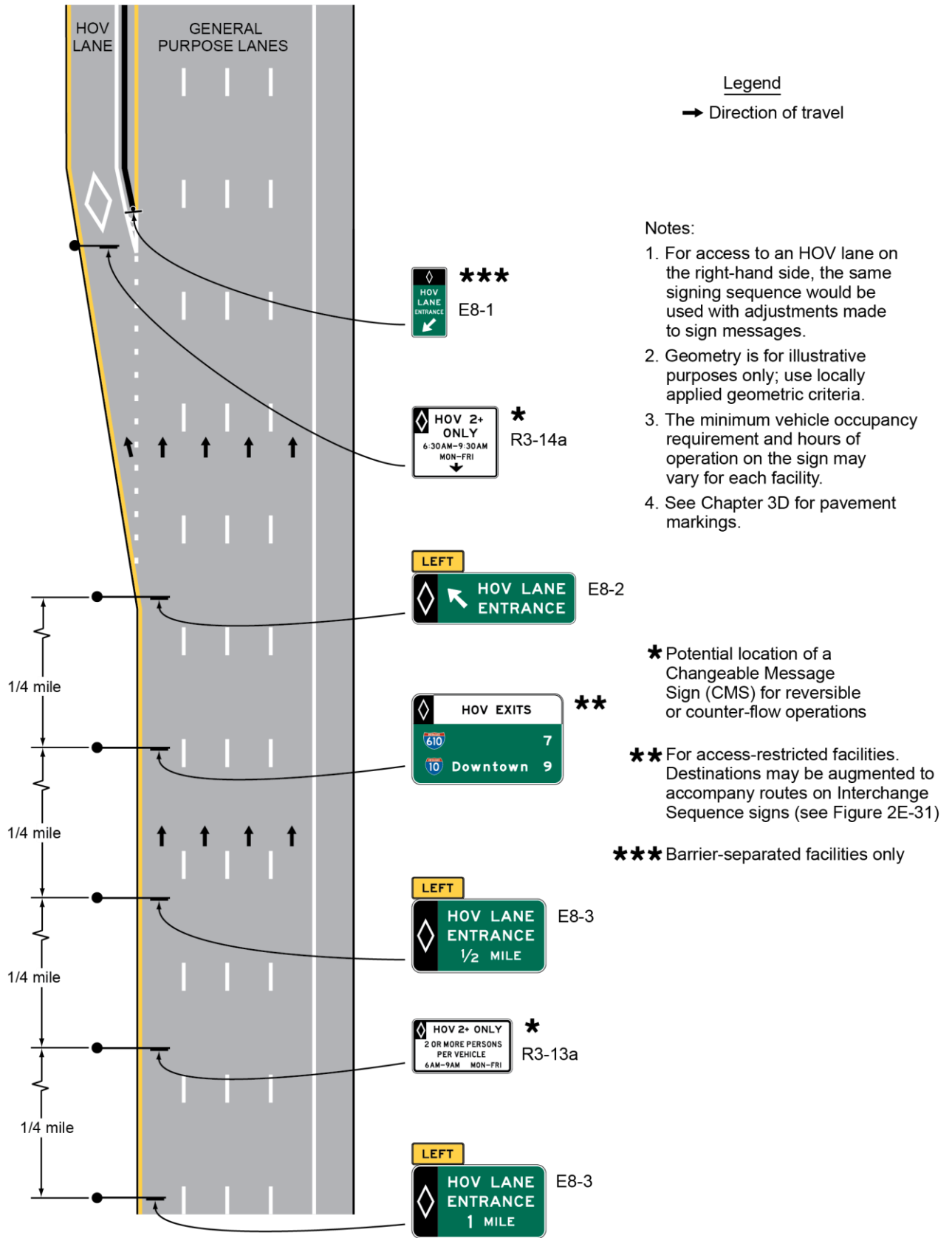

07 Figure 2G-8 shows an example of signs for the initial entry point to a preferential lane.

Section 2G.12 Guide Signs for Intermediate Entry Points to Preferential Lanes

Standard:

01 **For barrier-separated, buffer-separated, and contiguous preferential lanes where entry is restricted only to designated points, an overhead Preferential Lane Entrance Direction sign shall be provided at intermediate entry points to the preferential lane from the general-purpose lanes.**

Guidance:

02 *For barrier- and buffer-separated preferential lanes where intermediate entry from the general-purpose lanes is provided via a separate lane or ramp (see Figure 2G-9), at least one Advance Guide sign should be provided in addition to the Preferential Lane Entrance Direction sign.*

03 *For access-restricted preferential lanes where intermediate entrance and egress are at the same designated access location, the Preferential Lane Entrance Direction sign should be located between 1/2 and 1/4 of the length of the designated entry area, as measured from the downstream end of the entry area (see Figure 2G-10).*

Standard:

04 **The Advance Guide signs, if used for intermediate entry points to a preferential lane from the general-purpose lanes, shall be overhead.**

Option:

05 Advance Guide signs may be provided at approximately 1/2 mile, 1 mile, and 2 miles in advance of intermediate entry points from the general-purpose lanes to a preferential lane.

Standard:

06 **Advance Guide and Preferential Lane Entrance Direction signs for intermediate entry points shall not include the word “EXIT” (see Section 2G.10).**

Guidance:

07 *Exit Destination guide signs, identifying the final destination and downstream exit locations accessible from the preferential lane, should be installed in advance of intermediate entry points from the general-purpose lanes to access-restricted preferential lanes.*

Support:

08 Section 2G.11 contains information on the design and placement of Preferential Lane Exit Destination guide signs.

09 Figures 2G-9 and 2G-10 show examples of signs for various geometric configurations of intermediate entry to a barrier- or buffer-separated preferential lane where access is restricted to designated locations.

Section 2G.13 Guide Signs for Egress from Preferential Lanes to General-Purpose Lanes

Standard:

01 **For barrier-separated, buffer-separated, and contiguous preferential lanes where egress is restricted only to designated points, post-mounted Advance Guide and post-mounted Intermediate Egress Direction signs (see Figure 2G-11) shall be installed in the median or on median barriers that separate two directions of traffic prior to and at the intermediate exit points from the preferential lanes to the general-purpose lanes (see Figure 2G-10 and 2G-12).**

02 **The legends of these signs shall refer to the next exit or exits from the general-purpose lanes by displaying the appropriate destination information, exit number(s), or both. The Intermediate Egress Direction signs for egress from the preferential lanes to the general-purpose lanes shall not refer to the egress as an exit.**

Support:

03 Section 2G.10 contains information on the design of post-mounted guide signs applicable to a preferential lane when installed on a median barrier. Figures 2G-10 and 2G-12 show examples of signs for various geometric configurations of intermediate egress from a barrier- or buffer-separated preferential lane where access is restricted to designated locations.

Figure 2G-9. Example of Signing for an Intermediate Entry to a Barrier- or Buffer-Separated HOV Lane

Notes:

1. For access to an HOV lane on the right-hand side, the same signing sequence would be used with adjustments made to sign messages.
2. Geometry is for illustrative purposes only; use locally applied geometric criteria.
3. The minimum vehicle occupancy requirement and hours of operation on the sign may vary for each facility.
4. See Chapter 3D for pavement markings.
5. Warning signs are not shown.

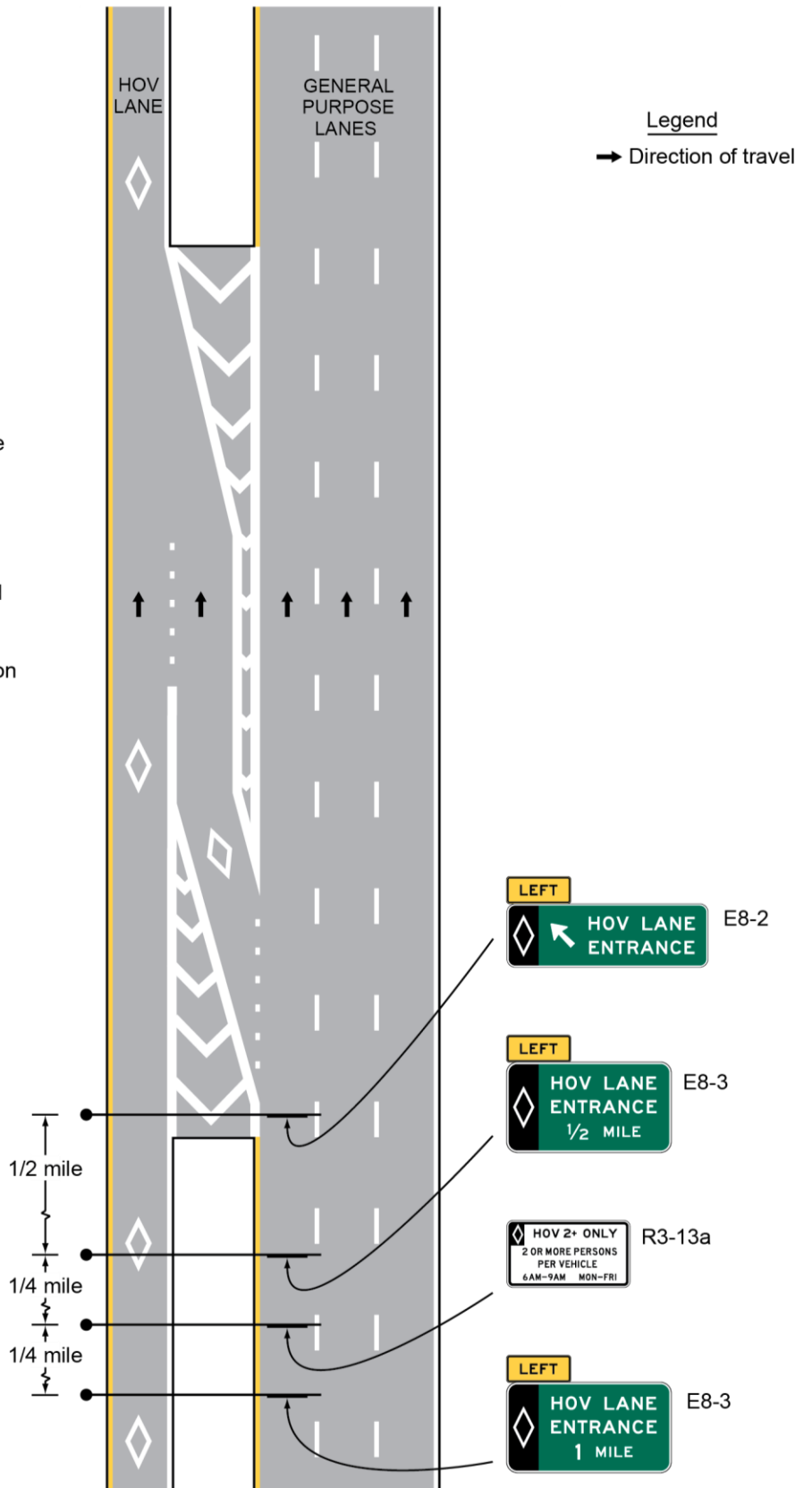

Figure 2G-10. Example of Signing for the Intermediate Entry to, Egress from, and End of Access-Restricted HOV Lanes

Notes:

1. Geometry is for illustrative purposes only; use locally applied geometric criteria.
2. The minimum vehicle occupancy requirement and hours of operation on the sign may vary for each facility.
3. See Chapter 3D for pavement markings.
4. Warning signs are not shown.

* Barrier-separated facilities only

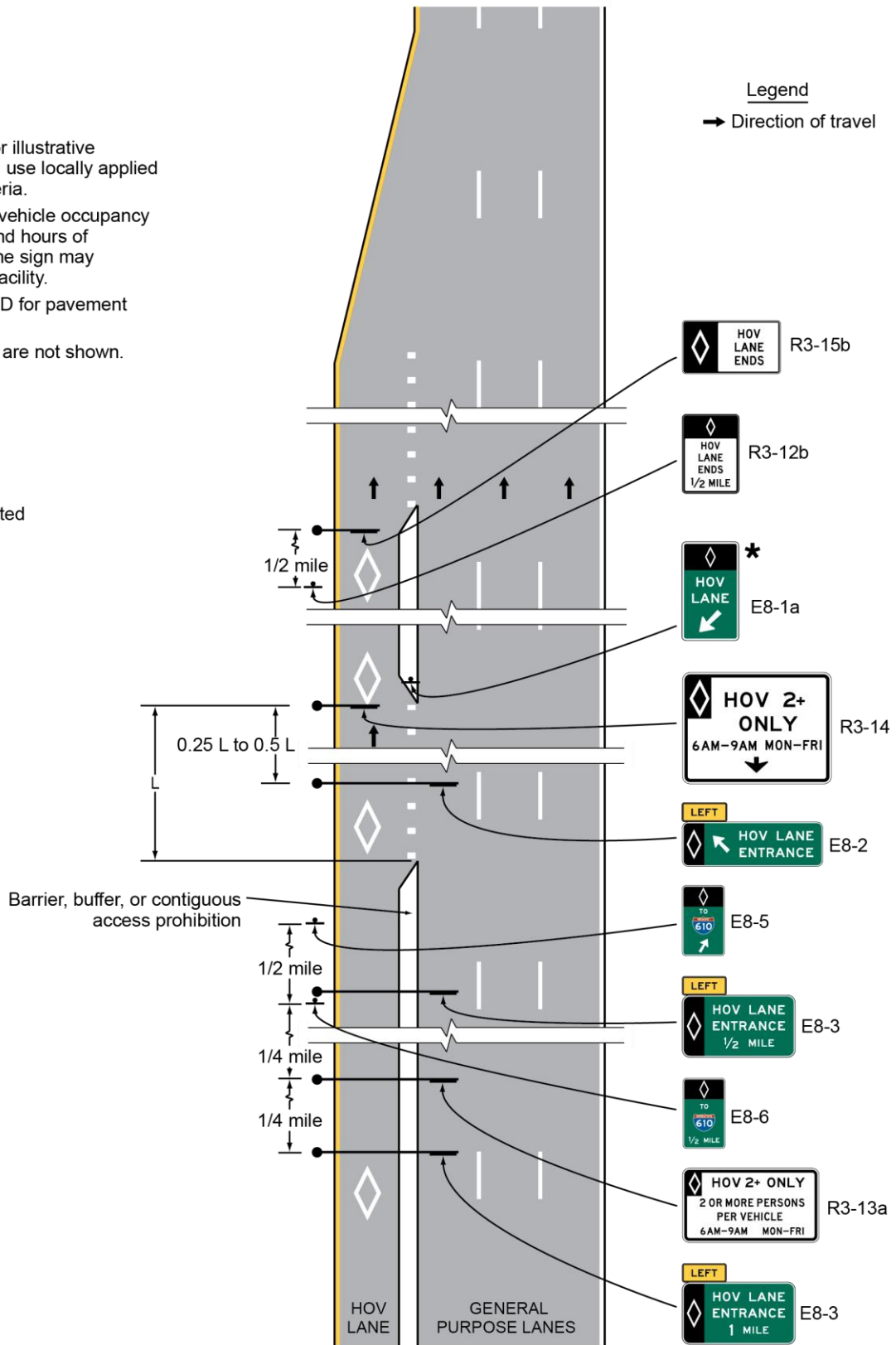

Figure 2G-11. Examples of Barrier-Mounted Guide Signs for an Intermediate Egress from Preferential Lanes



Note: Examples of HOV Lane (diamond symbol) signs are illustrated. For other types of preferential lanes, the appropriate symbol or word message (see Section 2G.03) is displayed in white on the black background of the top portion of these signs.

Guidance:

- 04 Where two or more adjacent preferential lanes are present in a single direction, consideration should be given to the use of overhead guide signs to display the information related to egress from the preferential lanes.
- 05 For barrier-separated and buffer-separated preferential lanes where egress from a preferential lane to the general-purpose lanes is restricted only to designated points via a separate lane or ramp, the Advance Guide and Intermediate Egress Direction signs for the egress should be mounted overhead and a Pull-Through sign should be mounted with the Intermediate Egress Direction sign (see Figure 2G-12).

Standard:

- 06 For preferential lanes that incorporate a vehicle occupancy requirement, the design of the overhead Advance Guide and Egress Direction signs for intermediate egress from the preferential lanes to the general-purpose lanes shall display a white diamond symbol on a black background at the left-hand edge of the signs.
- 07 The design of Pull-Through signs when used in conjunction with an Egress Direction sign at an intermediate egress from the preferential lanes to the general-purpose lanes shall be distinguished from those applicable to general-purpose lanes by inclusion of an upper section with the applicable black legend on a white background, such as HOV LANE. For preferential lanes that incorporate a vehicle occupancy requirement, the white diamond symbol on a black background shall be displayed at the left-hand edge of this upper section.

Section 2G.14 Guide Signs for Direct Entrances to Preferential Lanes from Another Highway

Standard:

- 01 For direct access ramps to preferential lanes from a transit facility (such as a park - ride lot or a transit station or terminal) that is accessible from surface streets, advance guide signs shall be provided along the adjoining surface streets to direct traffic into and through the transit facility to the preferential lane (see Figure 2G-13).

Support:

- 02 Figures 2G-13 and 2G-15 provide examples of recommended uses and layouts of signs for HOV lanes for direct access ramps, park - ride lots, and access from surface streets.

Section 2G.15 Guide Signs for Direct Exits from Preferential Lanes to Another Highway

Standard:

- 01 For contiguous preferential lanes on the left-hand side of the roadway, Advance Guide signs, Exit Direction signs, and Exit Gore signs (see Figure 2G-14) specifically applicable to the preferential lanes shall be used for exits to direct access ramps, such as HOV lane ramps (see Figure 2G-15) or ramps to park - ride facilities.
- 02 The design of Advance Guide, Exit Direction, and Pull-Through signs for direct exits from preferential lanes shall be distinguished from those applicable to general-purpose lanes by inclusion of

Figure 2G-12. Examples of Signs for an Intermediate Egress from a Barrier- or Buffer-Separated HOV Lane

Notes:

1. For an exit on the left-hand side from an HOV lane, the same signing sequence would be used with adjustments made to sign messages.
2. Geometry is for illustrative purposes only; use locally applied geometric criteria.
3. The minimum vehicle occupancy requirement and hours of operation on the sign may vary for each facility.
4. See Sections Chapter 3D for pavement markings.
5. Warning signs are not shown.
6. Figures 2D-3 and 2D-4 show the correct design of an Ohio State Route Sign.

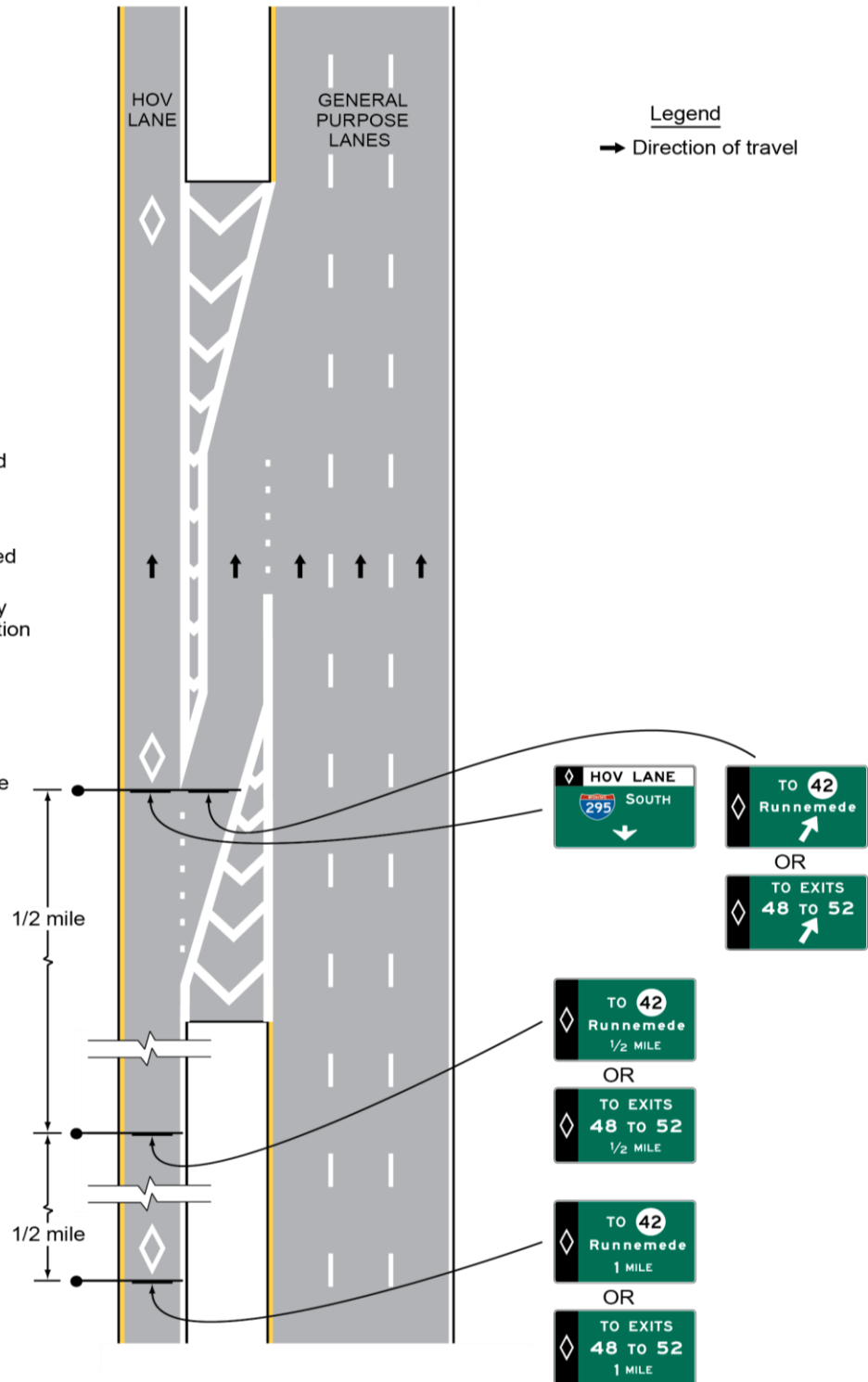
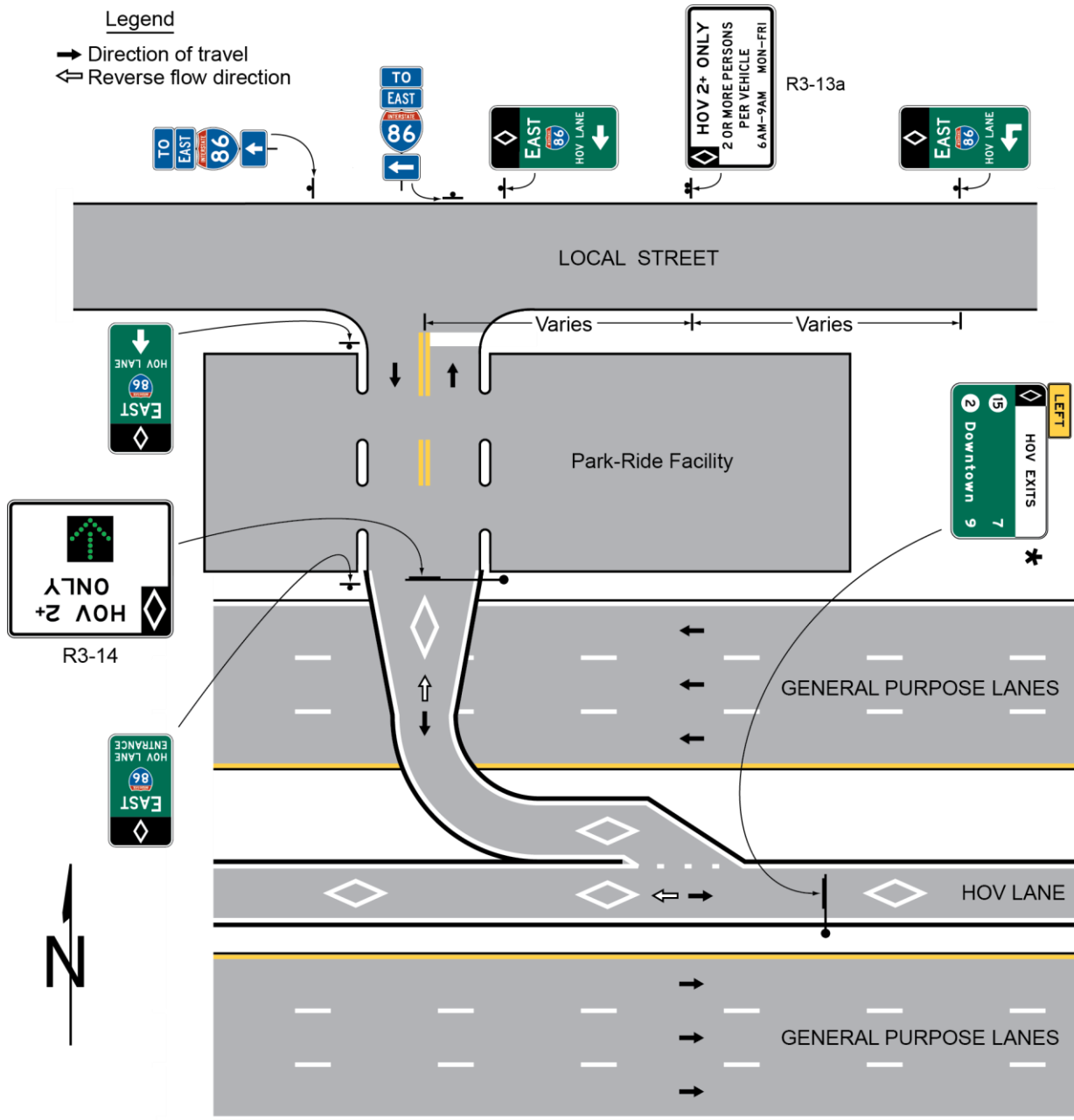

Figure 2G-13. Example of Signing for a Direct Entrance Ramp to an HOV Lane from a Park – Ride Facility and a Local Street



Notes:

1. The minimum vehicle occupancy requirement on the sign may vary for each facility.
 2. See Chapter 3D for pavement markings.
 3. Warning signs are not shown.
 4. Sign locations are approximate.
 5. Additional signs may be required to direct drivers from the surrounding streets into the park-ride lot and the HOV lane.
 6. Additional signs are required on the adjoining surface streets to inform non-HOVs that they should not enter the HOV facility.
 7. This figure illustrates a reversible HOV lane with a direct access ramp.
 8. The guide signs directing local street traffic to the HOV lane should include the word ENTRANCE when the direct access ramp does not traverse a park-ride facility.
 9. Figures 2D-3 and 2D-4 show the correct design of an Ohio State Route Sign.
- * For access-restricted facilities; destinations may be augmented to accompany routes on Interchange Sequence signs (see Figure 2E-31).

Figure 2G-14. Exit Gore Sign for a Direct Exit from a Preferential Lane

E8-4

Note: An example of an HOV Lane (diamond symbol) sign is illustrated. For other types of preferential lanes, the appropriate symbol or word message (see Section 2G.03) is displayed in white on the black background of the top portion of this sign.

an upper section with the applicable black legend on a white background, such as HOV LANE (for Pull-Through signs) or HOV EXIT (for Advance Guide and Exit Direction signs). For preferential lanes that incorporate a vehicle occupancy requirement, the white diamond symbol on a black background shall be displayed at the left-hand edge of this upper section (see Figures 2G-15 and 2G-16).

Guidance:

- 03 *Advance Guide and Exit Direction signs for exits to direct access ramps from a preferential lane should be mounted overhead. A Pull-Through sign should be used with the Exit Direction sign at exits to direct access ramps.*

Standard:

- 04 **Post-mounted guide signs in a vertical rectangular shape installed on a median barrier shall not be used for the Advance Guide and Exit Direction signs for exits to direct access ramps.**
- 05 **Because direct access ramps for preferential lanes at interchanges connecting two freeways are typically left-hand side exits and typically have design speeds similar to the preferential lane, overhead Advance Guide signs and overhead Exit Direction signs shall be provided in advance of and at the entry point to each freeway-to-freeway preferential lane ramp (see Figure 2G-16).**

Guidance:

- 06 *The use of guide signs for preferential lanes at freeway interchanges should comply with the provisions for guide signs established in this Manual.*

Support:

- 07 Guide signs for direct access ramps for preferential lanes at interchanges connecting two freeways are similar to those for a connecting ramp between two freeway facilities.

Section 2G.16 Signs for Priced Managed Lanes – General*Support:*

- 01 A priced managed lane is a managed lane that employs tolling or pricing, typically through electronic toll collection, to manage congestion levels and maintain a certain level of service for users of the facility. A priced managed facility typically provides a less congested alternative to adjacent lanes along the same designated route, or to a nearby facility, that experience recurring congestion during peak periods. A priced managed lane might allow non-toll travel by certain vehicles based on occupancy or other criteria. A variety of operational management strategies might be used in conjunction with tolling or pricing.
- 02 The number and combination of operational strategies that are applied to a managed lane to manage congestion or improve efficiency might be practically limited by the amount of information that can be legibly displayed on signs or in signing sequences and still be readily comprehended by road users. Such factors to consider when evaluating alternatives for managed lanes are locations of signs for general-purpose interchanges and for other roadway conditions, the number of intermediate access points between the managed and general-purpose lanes and the need to repeat the operational information, and the distance over which a signing sequence that displays all of the eligibility requirements can be displayed.
- 03 Because managed lanes have the capability to employ a variety of operational strategies on a changing basis, it is not practical to assign a naming convention to such lanes for the purpose of signing based on the specific operational management strategies, as is more readily accomplished with other types of preferential

Figure 2G-15. Examples of Guide Signs for Direct HOV Lane Entrance and Exit Ramps

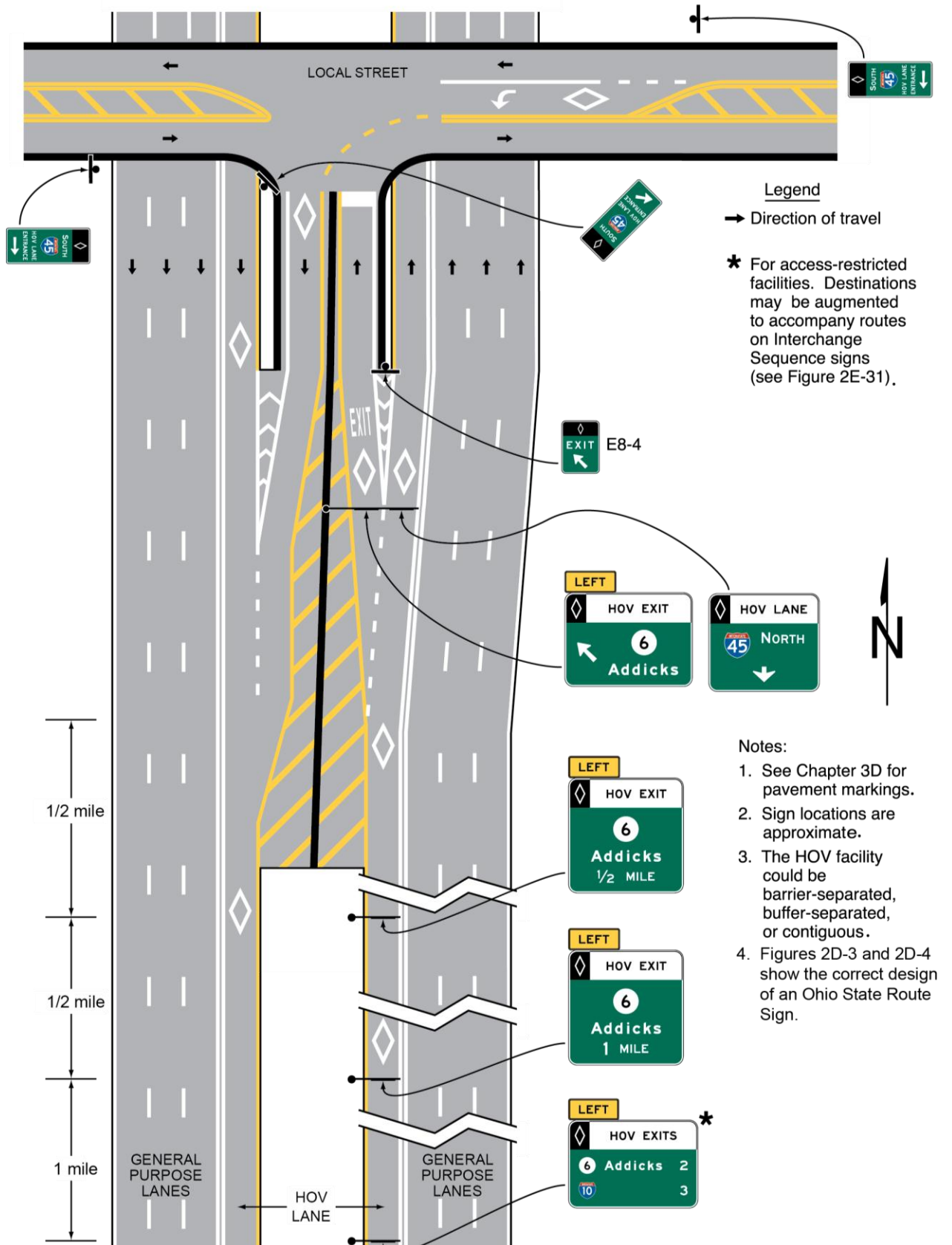
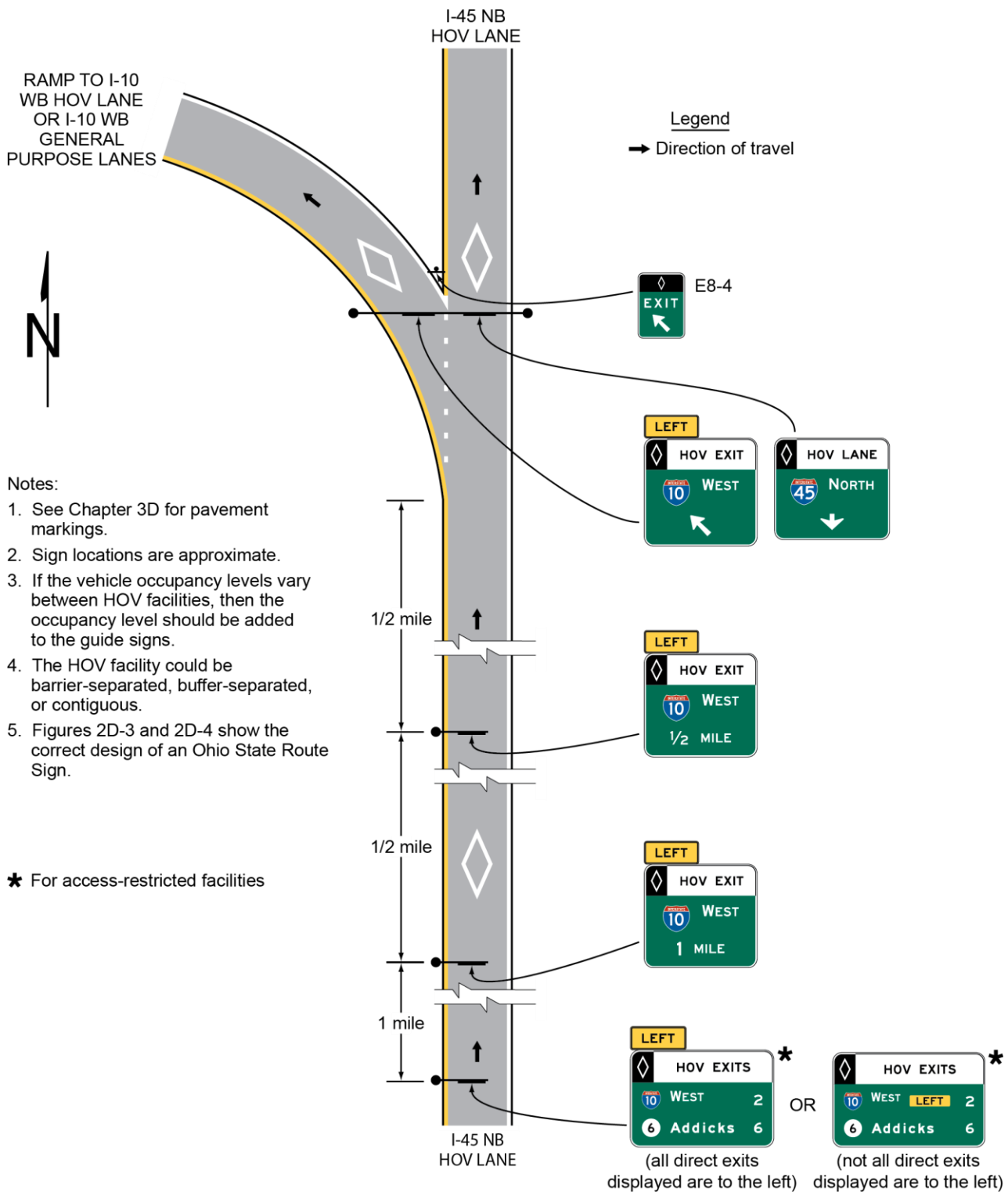

Figure 2G-16. Examples of Guide Signs for a Direct Access Ramp between HOV Lanes on Separate Freeways



lanes, such as HOV, Bus, or Bike lanes. Instead, the various requirements, restrictions, and eligibility criteria are more appropriately conveyed through a sequence of regulatory and guide signs with a more encompassing designation for the purpose of providing directional information.

- 04 As priced managed lanes become more prevalent as an operational strategy, it will be important to establish a uniform naming convention to distinguish those lanes that are an alternative to travel on adjacent general-purpose lanes on the same designated route to effectively communicate to motorists the range of basic requirements for similar facilities in different regions.

Standard:

- 05 **Priced managed lanes that are adjacent to general-purpose lanes along the same designated route shall be signed using the legend EXPRESS or EXPRESS LANE(S). This provision shall apply when any of the following operational strategies is used for a managed lane:**

- A. All users of the managed lane are charged a fixed or variable toll;
- B. General-purpose traffic using the managed lane is charged a fixed or variable toll, but HOV traffic is allowed to travel without being charged a toll on either a full- or part-time basis;
- C. General-purpose traffic using the managed lane is charged a fixed or variable toll, but HOV traffic is offered a discounted toll on either a full- or part-time basis; or
- D. General-purpose traffic using the managed lane is charged a fixed or variable toll, but HOV traffic registered with a local program travels at a discounted toll or without being charged a toll on either a full- or part-time basis (a transponder or other identifier is typically required of HOVs to indicate registration in conjunction with electronic or visual enforcement and verification of vehicle occupancy).

- 06 **The legends EXPRESS and EXPRESS LANE(S) shall not be used on signs for entrances to highways on which all lanes are managed and there are no adjacent general-purpose lanes on the same designated route. The legends EXPRESS and EXPRESS LANE(S) shall not be used on signs for a managed ramp connection that provides an alternative to a general-purpose ramp connection (see Figure 2F-7), except where the ramp leads directly to a managed lane as described in Section 2G.16. The legends EXPRESS and EXPRESS LANE(S) shall not be used on signs for open-road tolling lanes that bypass a conventional toll plaza (see Chapter 2F).**

- 07 **The diamond symbol shall be reserved exclusively for preferential lanes whose operational strategy is occupancy-based only (see Sections 2G.03 through 2G.14) and shall not be used to designate a managed lane in which other operational strategies, such as tolling and pricing, are employed to allow general-purpose traffic to use the lane.**

Section 2G.17 Regulatory Signs for Priced Managed Lanes

Standard:

- 01 **Except as otherwise provided in this Section, the provisions of Sections 2G.03 through 2G.07 regarding regulatory signs for Preferential lanes shall apply to priced managed lanes operated at all times or at certain times with a toll payment requirement of some or all vehicles to use the lane(s). Such managed lanes shall use changeable message signs or changeable message elements within static signs to display the appropriate regulatory sign messages only when they are in effect.**

- 02 **Regulatory signs for preferential lanes shall be appropriately modified for adaptation to a priced managed lane, where applicable, as shown in Figure 2G-17.**

- 03 **Regulatory signs shall be used to indicate the toll charged. If the toll varies, regulatory signs that include changeable message elements, such as the R3-48 and R3-48a signs that are shown in Figure 2G-17, shall be used to display the actual toll amount in effect at any given time.**

- 04 **When only vehicles with a registered ETC account are allowed to use a managed lane where some or all vehicles are charged a toll, regulatory signs to indicate such a restriction shall be provided and shall incorporate the pictograph adopted by the toll facility's ETC payment system and the word ONLY (see Section 2G.18 for the incorporation of such regulatory legends into the guide signs for the entrances to such facilities). The display of the ETC system pictograph shall comply with the provisions of Sections 2F.03 and 2F.04 as shown in Figures 2G-17 and 2G-18.**

- 05 **When HOV traffic is allowed to use a priced managed lane without paying a toll and registration in a local program is not required to receive the toll exemption, the Vehicle Occupancy Definition (R3-**

Figure 2G-17. Regulatory Signs for Managed Lanes

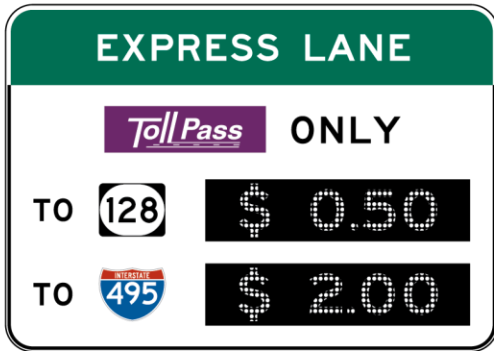

R3-48

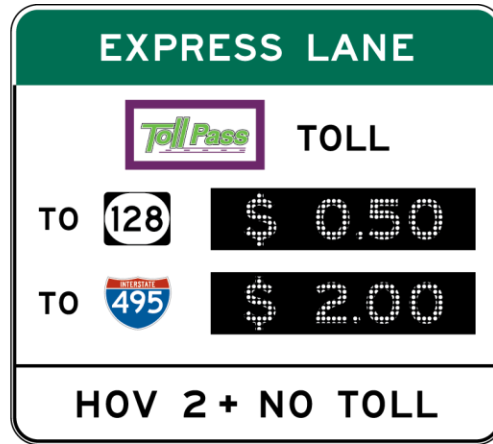

R3-48a

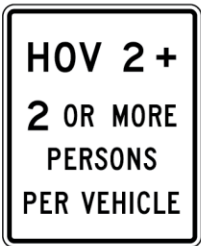

R3-40



R3-42



R3-42a



R3-42b



R3-42c

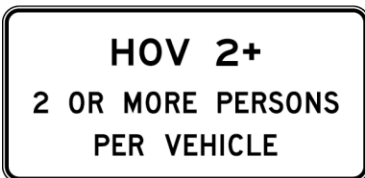

R3-43



R3-44



R3-44a



R3-45



R3-45a

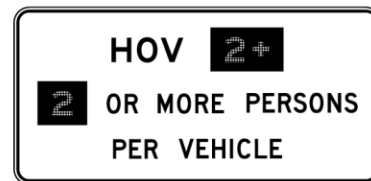

Example of regulatory sign with changeable message elements

Notes:

1. The ETC pictograph shown is an example only. The pictograph for the toll facility's adopted ETC system, shall be used.
2. Changeable message sign elements shall be used for the numerals displayed for the variable tolls.
3. Figures 2D-3 and 2D-4 show the correct design of an Ohio State Route sign.

10 or R3-13) signs (see Section 2G.04) shall be modified to delete the diamond symbol to create priced managed lane Vehicle Occupancy Definition (R3-40 and R3-43) signs to indicate the minimum occupancy related to the management strategy (see Figure 2G-17).

- 06 **An R3-44 or R3-44a sign (see Figure 2G-17) shall be installed at the beginning or initial entry point, and at any intermediate entry points where vehicles are allowed to legally enter an access-restricted priced managed lane.**
- 07 **When the vehicle occupancy required for non-toll use of a managed lane is varied as a part of a priced managed lane operational strategy, regulatory signs that include changeable message elements shall be used to display the required vehicle occupancy in effect for non-toll travel.**

Option:

- 08 **Where registration in a local program or ETC account is required for HOV traffic to travel in a priced managed lane without being charged a toll or by being charged a discounted toll, such information may be displayed on a separate sign within the sequence of the required regulatory and guide signs.**

Standard:

- 09 **R3-42 Series and R3-45 Series signs (see Figure 2G-17) shall be installed in accordance with the provisions of Section 2G.07 to indicate the termination of a priced managed lane or restriction. The R3-42, R3-42a, and R3-45 signs shall be used only where the managed lane and restriction end and traffic must merge into the general-purpose lanes. The R3-42b, R3-42c, and R3-45a signs shall be used only where the managed lane restriction ends and the lane becomes a general-purpose lane.**

Figure 2G-18. Examples of Guide Signs for Entrances to Priced Managed Lanes

A - ENTRANCE TO A PRICED MANAGED LANE FROM A GENERAL PURPOSE LANE



B - DIRECT ENTRANCE TO A PRICED MANAGED LANE FROM A CROSSROAD



Note: 1. The ETC pictographs shown are examples only. The pictograph for the toll facility's adopted ETC system shall be used.
 2. The examples shown are for facilities on which registration in a toll account program is required for toll payments.

Section 2G.18 Guide Signs for Priced Managed Lanes

Standard:

01 Except as otherwise provided in this Section, guide signs for barrier-separated, buffer-separated, and contiguous managed lanes shall follow the specific provisions for Preferential Lane guide signs contained in Sections 2G.10 through 2G.15. Except as otherwise provided in this Section, guide signs for highways on which all lanes are managed shall follow the general provisions for freeway and expressway guide signs as contained in Chapter 2E as a

whole. Guide signs for highways on which all lanes are managed and tolling or pricing is used as a management strategy shall follow the applicable provisions for toll road guide signs as contained in Chapter 2F, in addition to the general provisions of Chapter 2E.

02 If fixed or variable tolls are used as an operational strategy for a managed lane, the guide signs shall comply with the provisions of Sections 2F.03, 2F.04, and 2F.17 regarding the use, size, and placement of ETC-account pictographs.

Support:

03 Figure 2G-18 shows examples of Guide signs for entrances to priced managed lanes and other ETC account-only toll facilities that incorporate header panels with ETC account pictographs and regulatory legends.

Guidance:

04 *Exit Destination supplemental guide signs, identifying final destination and downstream exit locations accessible from the managed lane (see Figure 2G-19), should be installed in advance of the initial entry points to priced managed lanes. These signs should be located in accordance with the provisions of Paragraph 5 of Section 2G.11.*

05 *For managed lanes that are available as an alternative to travel on adjacent general-purpose lanes on the same designated route, changeable message signs indicating the comparative travel times or congestion levels using the managed lanes versus the general-purpose lanes (see Figure 2G-20) should be installed in advance of the initial and intermediate entry points to the managed lanes.*

Option:

06 Changeable message signs may also be used on non-managed highways to display comparative travel times or congestion levels for a nearby managed highway.

Standard:

07 **Guide signs at the initial and intermediate entry points to a priced managed lane in which all general-purpose passenger vehicles are allowed shall include the legend EXPRESS or EXPRESS LANE(S). The guide signs shall incorporate the pictograph of the ETC account system into a header panel within the guide sign in accordance with Sections 2F.03, 2F.04, and 2F.17. For a priced managed lane that allows non-toll travel by HOV traffic without registration in a local program, the header panel shall be modified to a regulatory format to display both the pictograph of the ETC account system and the minimum occupancy requirement for non-toll travel with a black legend on a white background (see Figure 2G-18).**

08 **Guide signs at the initial and intermediate entry points to a managed lane that allows only HOV traffic with either a fixed or variable occupancy requirement shall follow the provisions of Sections 2G.10 through 2G.12 and 2G.14.**

Figure 2G-19. Example of an Exit Destination Sign for a Managed Lane



Figure 2G-20. Example of a Comparative Travel Time Information Sign for Preferential or Managed Lanes



Notes:

1. The ETC pictograph shown is an example only. The pictograph for the toll facility's adopted ETC system shall be used.
2. CMS elements shall be used for the numerals displayed for the estimated travel times.

Support:

- 09 Figures 2G-21 through 2G-24 show examples of guide signs for various configurations of initial and intermediate entrances to a priced managed lane.

Standard:

- 10 **The use and locations of guide signs for intermediate egress locations and direct exits from a priced managed lane (see Figures 2G-24 through 2G-27) shall comply with the provisions of Sections 2G.13 and 2G.15. The signs shall be suitably modified to display header messages of white legend on a green background that relate the guide sign legends to the managed lane(s) as appropriate in accordance with the following:**
- A. **Post-mounted or overhead-mounted Advance Guide signs for intermediate egress to the general-purpose lanes shall include the legend LOCAL EXITS in a header panel within the guide signs, destination information or the exit number(s) for the next exit(s) accessible from the general-purpose lanes, and the appropriate distance information to the location of the egress (see Figures 2G-24 and 2G-25).**
 - B. **Post-mounted or overhead-mounted Intermediate Egress Direction signs shall include the legend LOCAL EXITS in a header panel within the signs, the destination information or the exit number(s) of the next exit(s) accessible from the general-purpose lanes, and a diagonally upward-pointing directional arrow (see Figures 2G-24 and 2G-25).**
 - C. **For direct exits to another roadway, the legend EXPRESS EXIT shall be used on the Advance Guide and Exit Direction signs (see Figure 2G-26).**
 - D. **For pull-through signs, the legend EXPRESS LANE(S) shall be used, either as a header panel within the pull-through sign or as the principal legend of the sign without a header panel (see Figures 2G-25, 2G-26, and 2G-27).**

Support:

- 11 Section 2G.13 contains information on the use of overhead-mounted guide signs for intermediate egress to the general-purpose lanes.
- 12 Figures 2G-28 and 2G-29 show examples of guide signing for direct entrances to a priced managed lane from a crossroad or surface street.

Figure 2G-21. Example of Signing for the Entrance to an Access-Restricted Priced Managed Lane

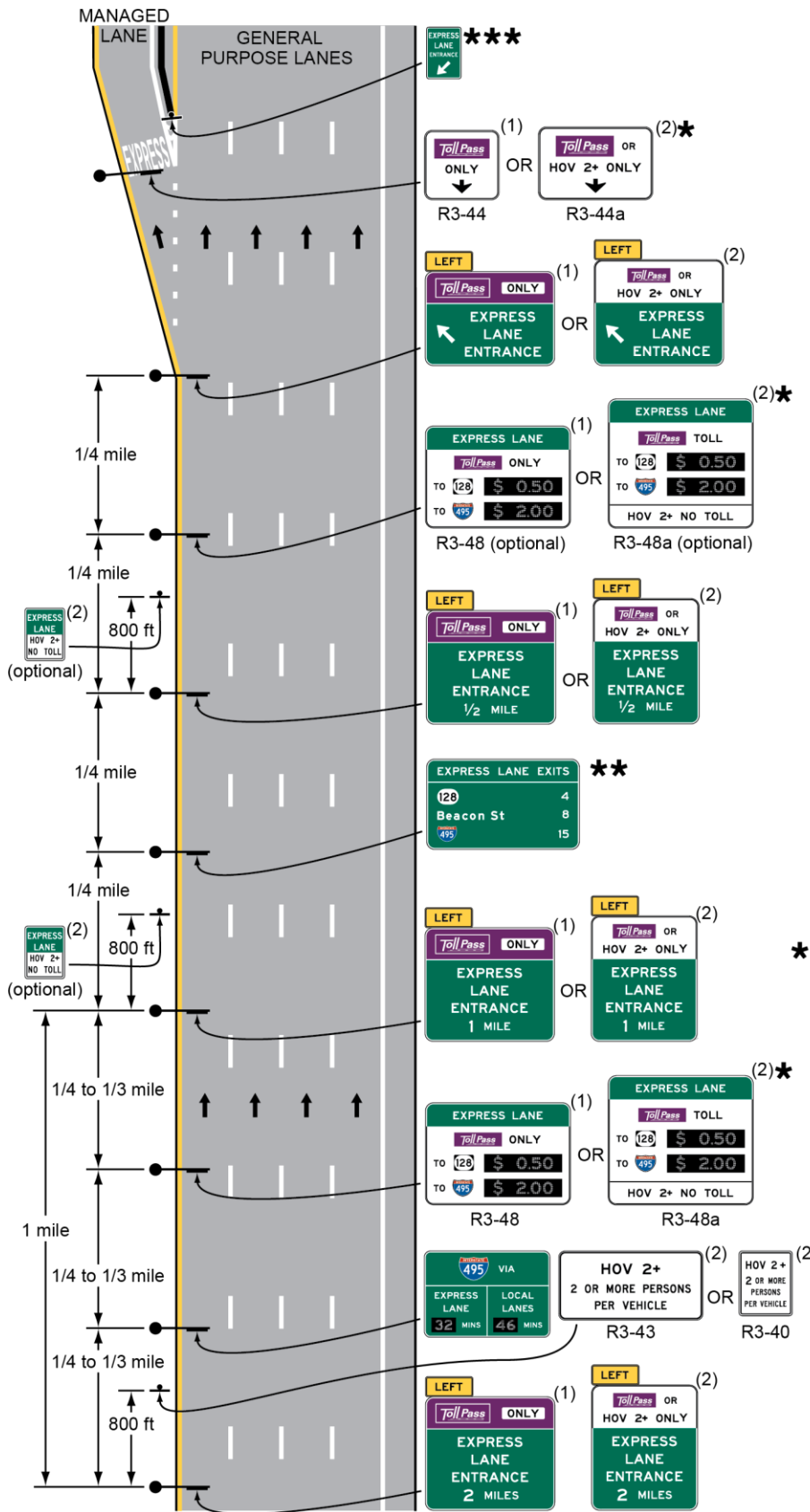

Legend
 → Direction of travel

Notes:

1. For access to a managed lane on the right-hand side, the same signing sequence would be used with adjustments made to sign messages.
2. Geometry is for illustrative purposes only; use locally applied geometric criteria.
3. The minimum vehicle occupancy requirement and hours of operation on the sign may vary for each facility.
4. See Chapter 3D for pavement markings.
5. Figures 2D-3 and 2D-4 show the correct design of an Ohio State Route Sign.

- * Potential location of a Changeable Message Sign (CMS) for reversible or contraflow operations
- ** For access-restricted facilities; destinations may be augmented to accompany routes on Interchange Sequence signs (see Figure 2E-31)
- *** Barrier-separated facilities only

- (1) All vehicles must have a registered ETC account. Toll discounts or exemptions through a registration program might be applicable for certain vehicles.
- (2) All vehicles except HOV must have a registered ETC account. If registration is required for non-toll travel by HOV traffic, case (1) signing shall be used.

Figure 2G-22. Example of Signing for the Entrance to an Access-Restricted Priced Managed Lane Where a General-Purpose Lane Becomes the Managed Lane

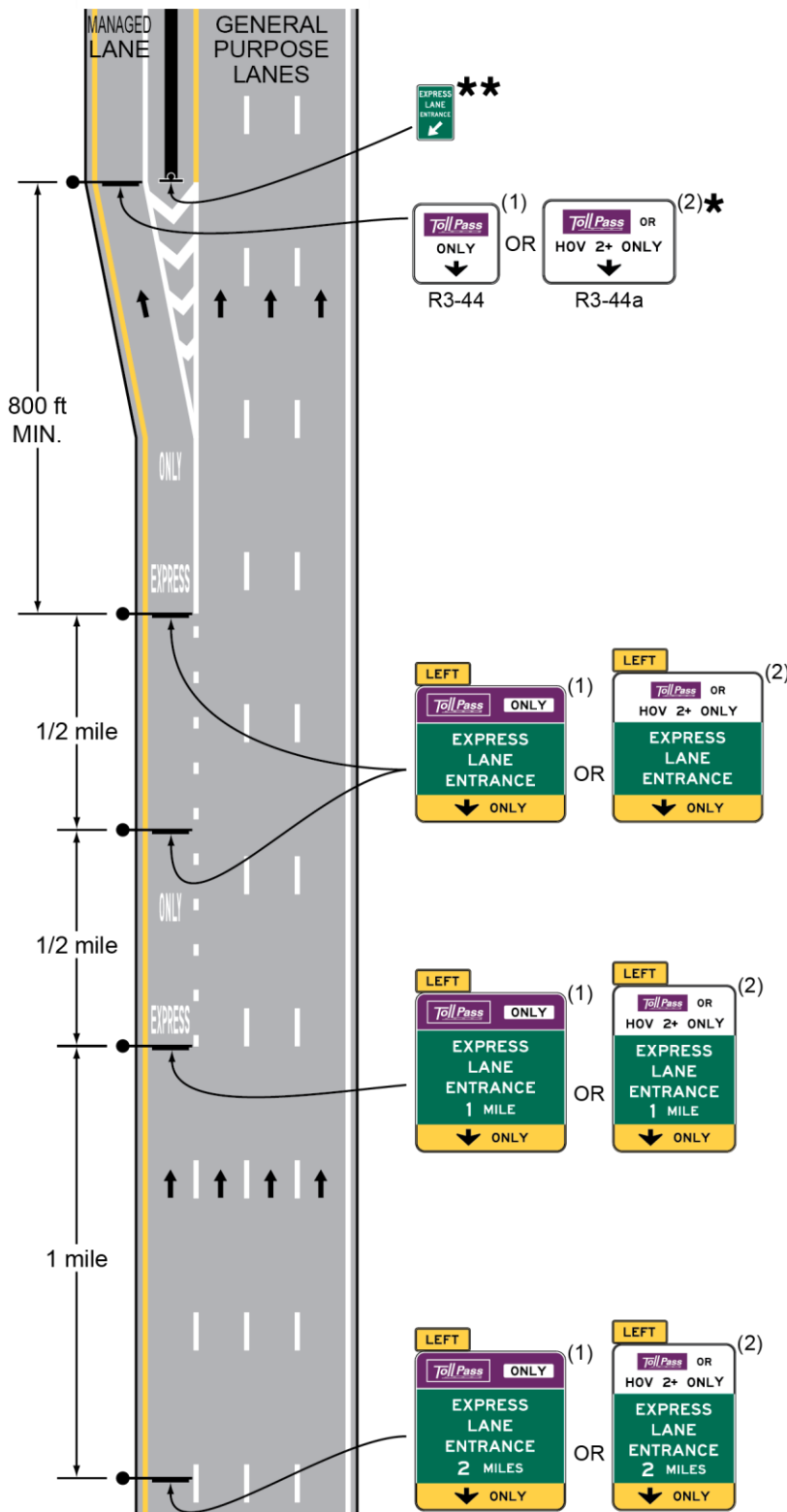

Notes:

1. For access to a managed lane on the right-hand side, the same signing sequence would be used with adjustments made to sign messages.
2. Geometry is for illustrative purposes only; use locally applied geometric criteria.
3. The minimum vehicle occupancy requirement and hours of operation on the sign may vary for each facility.
4. See Chapter 3D for pavement markings.
5. See Figure 2G-21 for additional signing.

- * Potential location of a Changeable Message Sign (CMS) for reversible or contraflow operations
- ** Barrier-separated facilities only

- (1) All vehicles must have a registered ETC account. Toll discounts or exemptions through a registration program might be applicable for certain vehicles.
- (2) All vehicles except HOV must have a registered ETC account. If registration is required for non-toll travel by HOV traffic,

Figure 2G-23. Example of Signing for an Intermediate Entry to a Barrier- or Buffer-Separated Priced Managed Lane

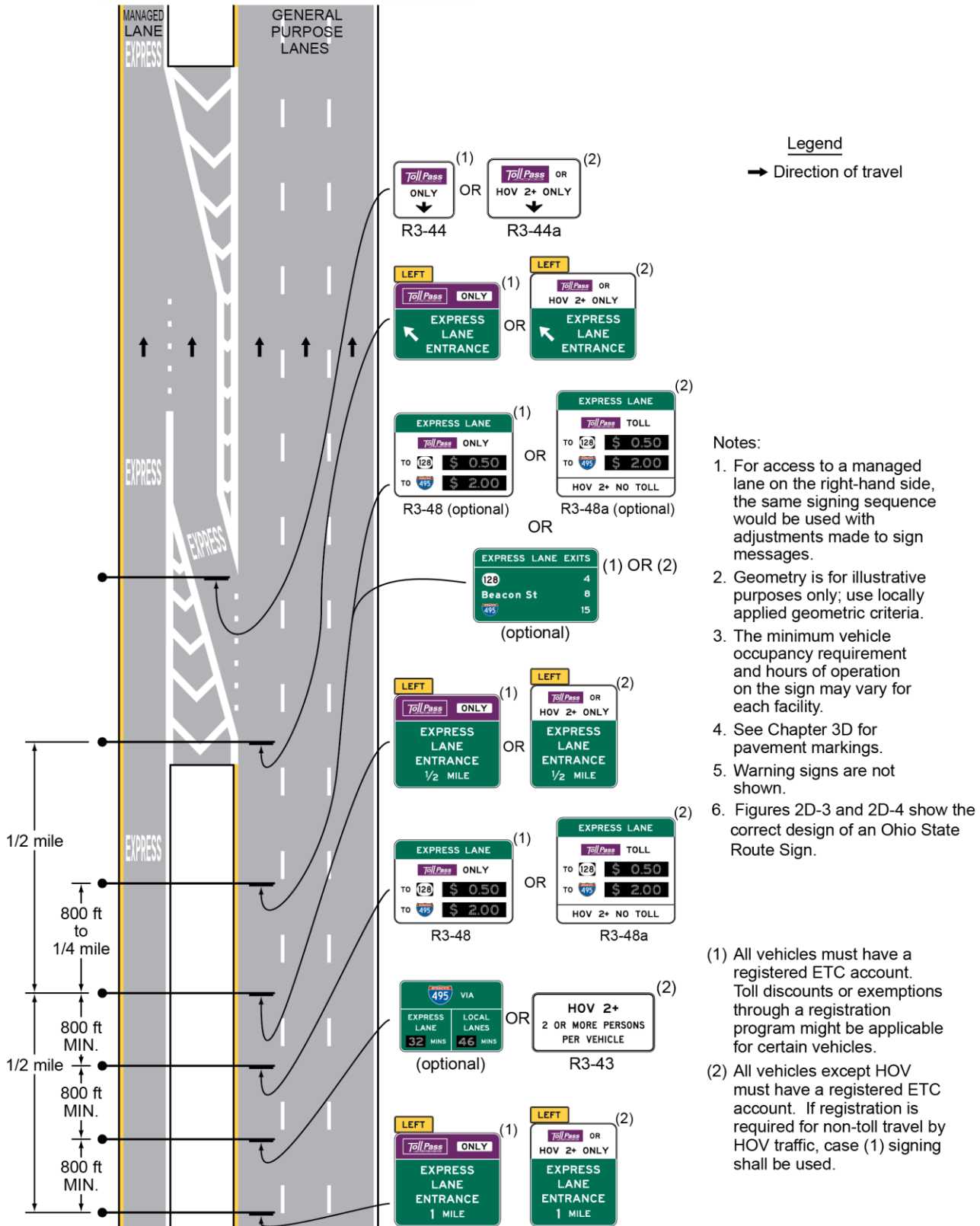

Figure 2G-24. Example of Signing for the Intermediate Entry to, Egress from, and End of Access-Restricted Priced Managed Lane

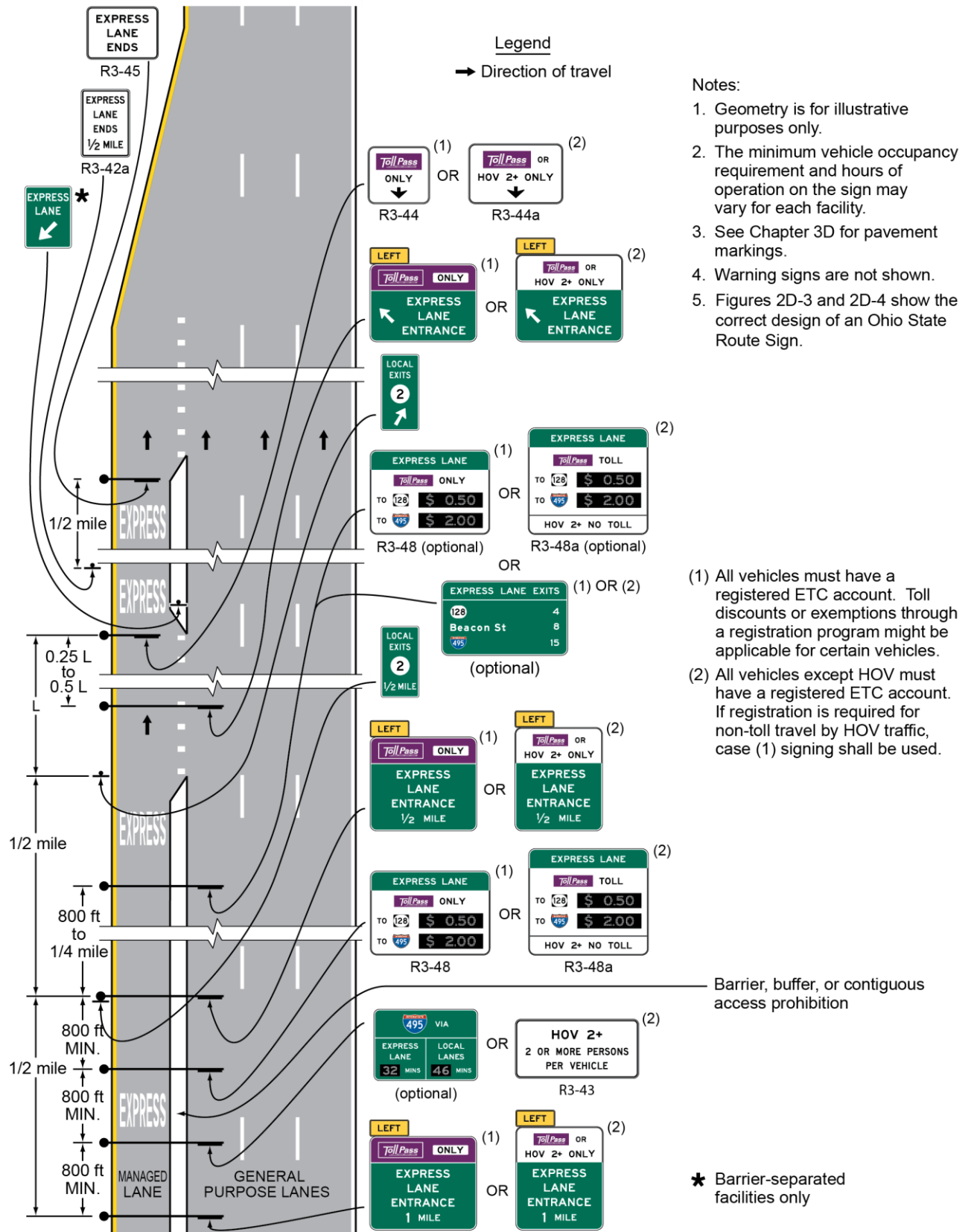

Figure 2G-25. Example of Guide Signs for an Intermediate Egress from a Barrier- or Buffer-Separated Managed Lane

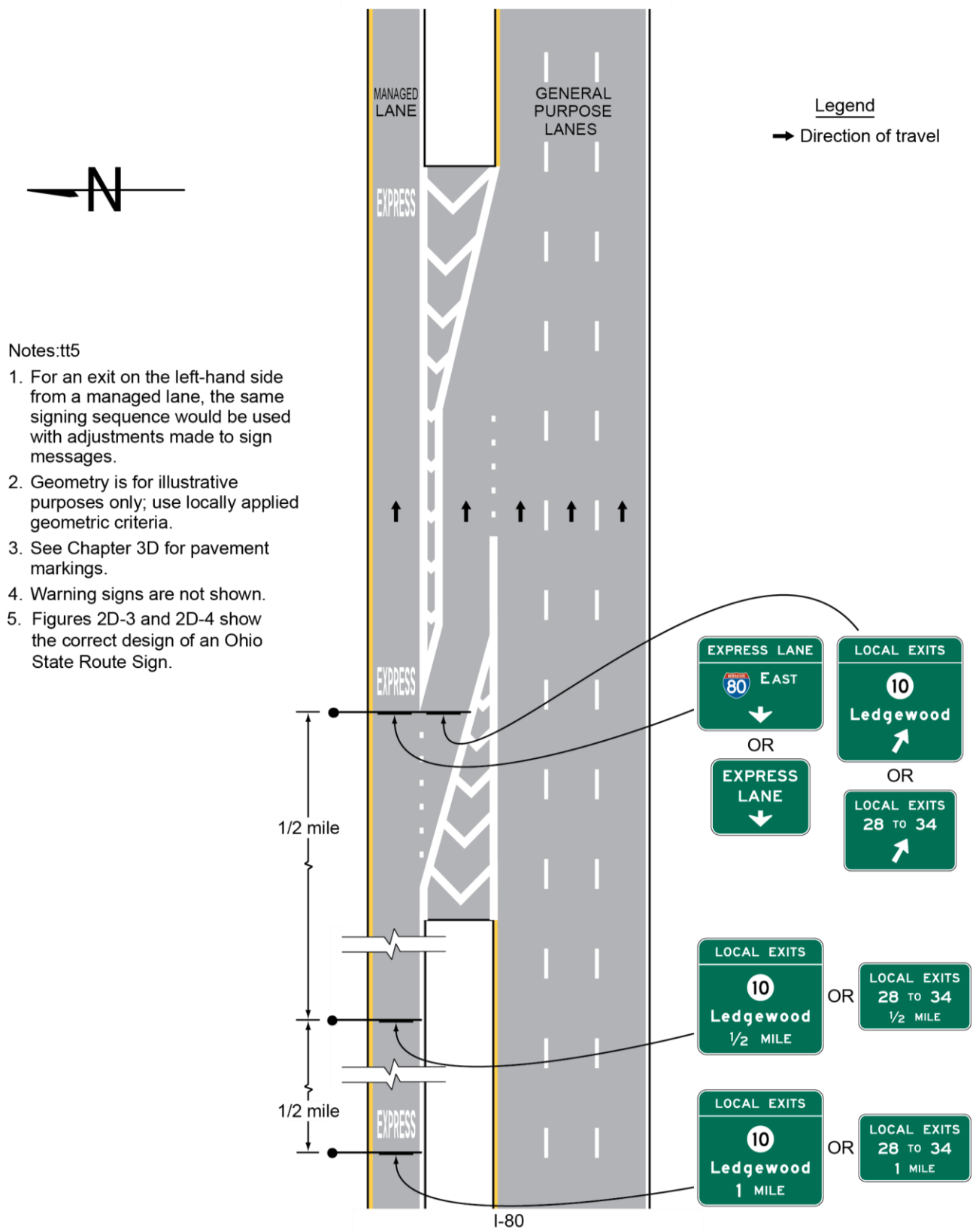

Figure 2G-26. Examples of Guide Signs for Direct Managed Lane Entrance and Exit Ramps

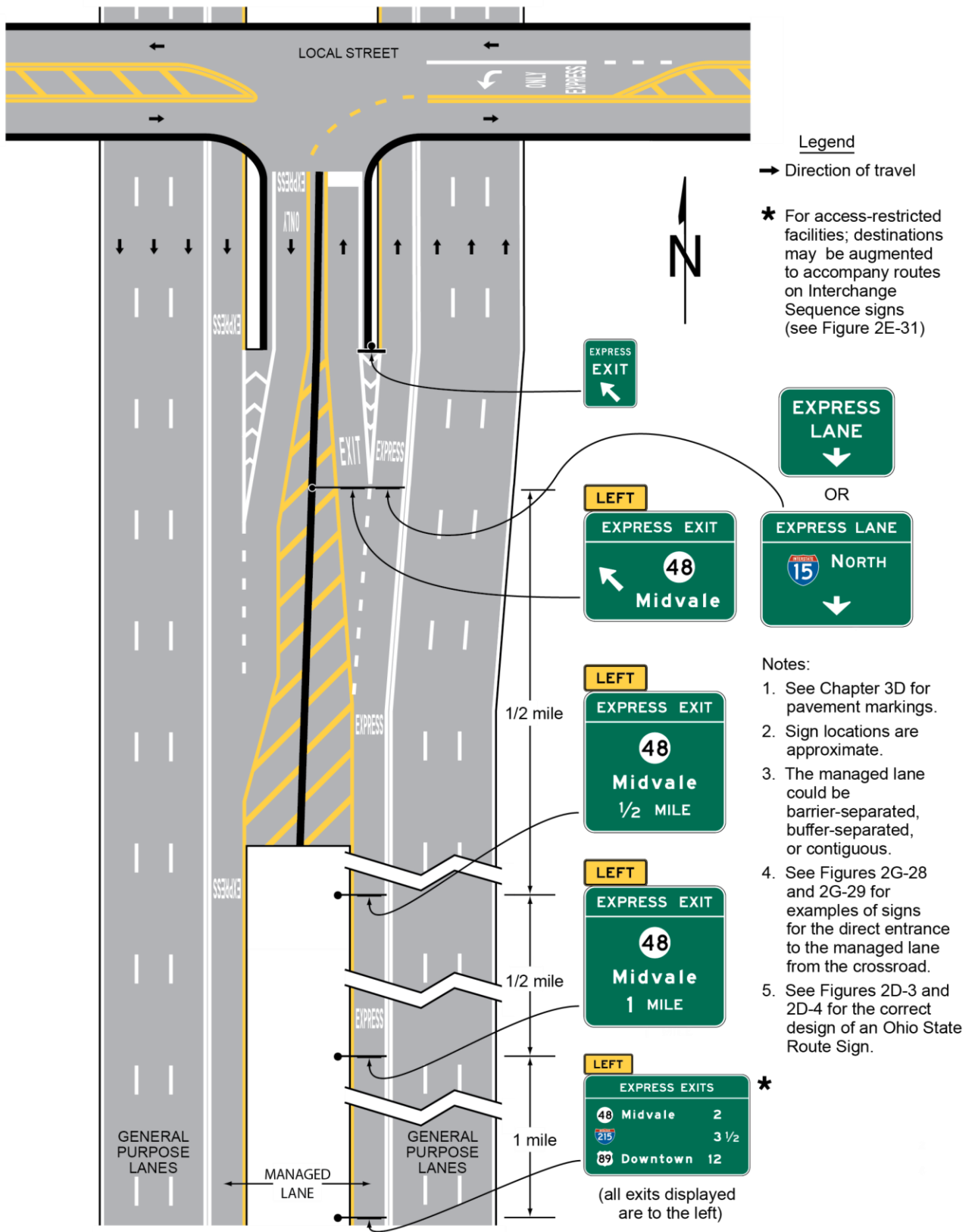

Figure 2G-27. Examples of Guide Signs for a Direct Access Ramp between Managed Lanes on Separate Freeways

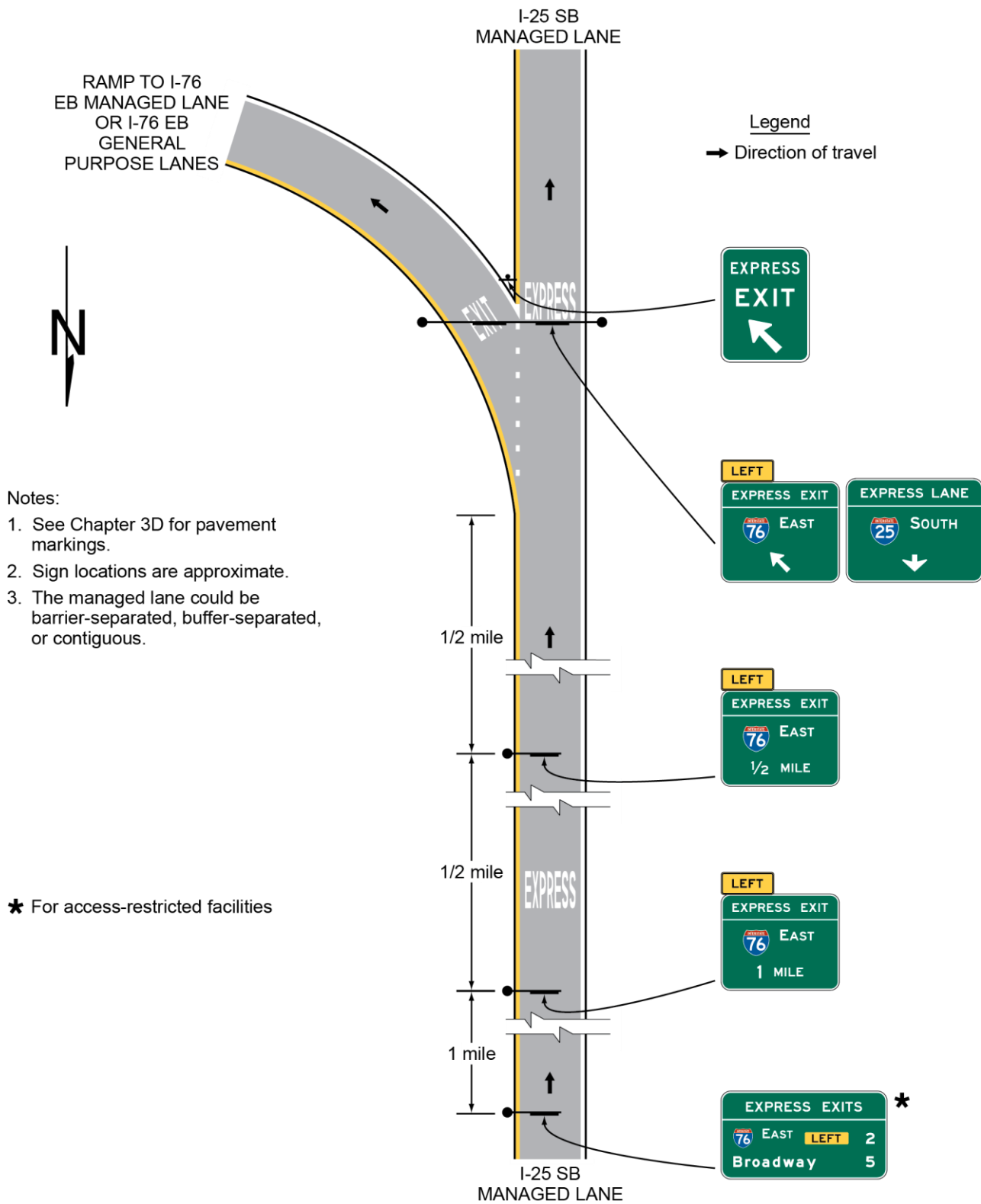

Figure 2G-28. Examples of Guide Signs for a Direct Entrance Ramp to a Priced Managed Lane and Trailblazing to a Nearby Entrance to the General-Purpose Lanes

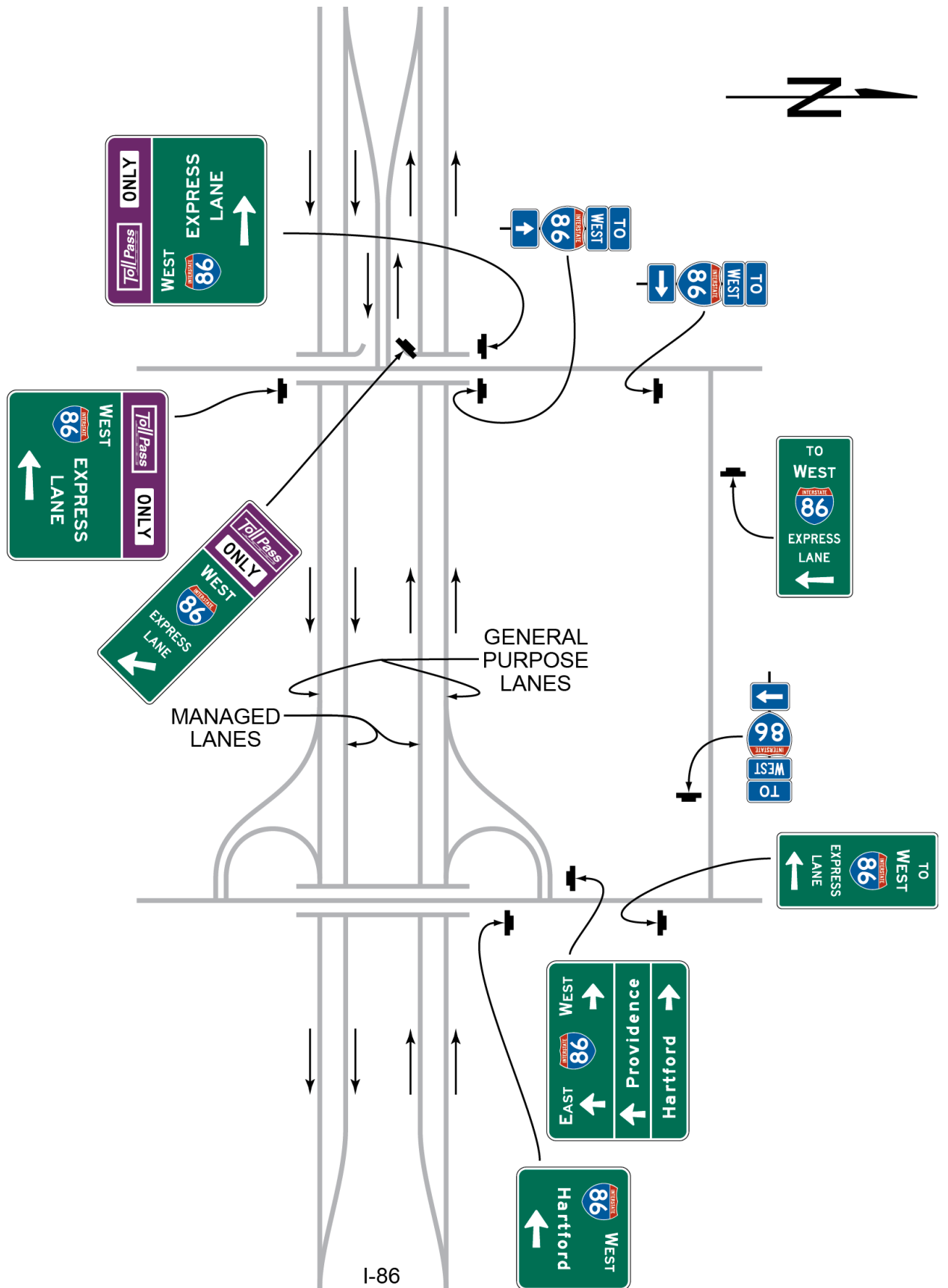
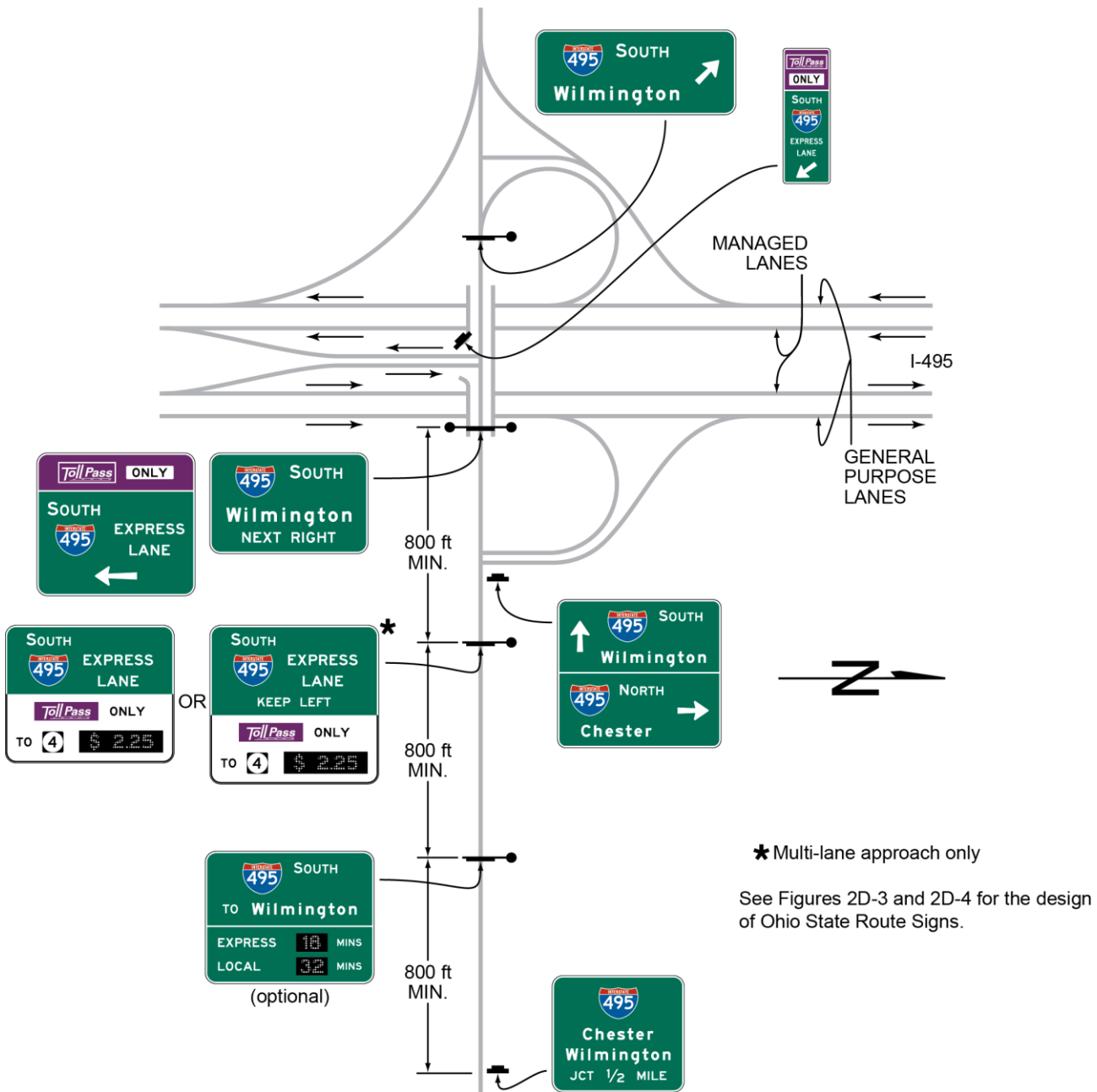

Figure 2G-29. Examples of Guide Signs for Separate Entrance Ramps to General-Purpose and Priced Managed Lanes from the Same Crossroad



* Multi-lane approach only

See Figures 2D-3 and 2D-4 for the design of Ohio State Route Signs.

CHAPTER 2H. GENERAL INFORMATION SIGNS

Section 2H.01 Sizes of General Information Signs

Standard:

- 01 **Except as provided in Section 2A.11, the sizes of General Information signs that have a standardized design shall be as shown in Table 2H-1 and the “Sign Designs and Markings Manual” (SDMM) (see Section 1A.11).**

Support:

- 02 Section 2A.11 contains information regarding the applicability of the various columns in Table 2H-1.

Option:

- 03 Signs larger than those shown in Table 2H-1 may be used (see Section 2A.11).

Section 2H.02 General Information Signs (I Series)

Support:

- 01 Of interest to the traveler, though not directly necessary for guidance, are numerous kinds of information that can properly be conveyed by general information signs (see Figure 2H-1) or miscellaneous information signs (see Section 2H.04 and Appendix C). They include such items as State lines, city limits, other political boundaries, time zones, stream names, elevations, landmarks, and similar items of geographical interest, and safety and transportation-related messages. Chapter 2M contains recreational and cultural interest area symbol signs that are sometimes used in combination with General Information signs.

Guidance:

- 02 *A State Line (I-2, I-H2, or E8-H1) sign should be erected where a route enters the State of Ohio from another state.*

- 03 *The Corporation Limit (I-H2a) sign should be installed where a route enters a municipality.*

Option:

- 04 Where a route leaves a municipality and subsequently re-enters the same municipality within a relatively short distance, the ENTER CORP (I-H2b) sign may be used at the re-entry location.

- 05 The LEAVE CORP (I-H2c) sign may be used at a location where a route leaves a municipality.

- 06 The Unincorporated Community (I-H2d) sign may be used to identify unincorporated communities of regional significance.

Guidance:

- 07 *When used, the Unincorporated Community sign should be placed near the edge of the community.*

Option:

- 08 The Township Limit (I-H2e) sign may be used to identify the boundaries of a township located outside municipal corporation limits.

Standard:

- 09 **In accordance with the provisions of Section 503.061 of the Ohio Revised Code, when requested by a township, ODOT shall erect Township Limit (I-H2e) signs on state routes outside municipal corporations.**

- 10 **When used, the Township Limit sign shall be placed where a route enters a township.**

Guidance:

- 11 *On a conventional road, the Internal County Line (I-H2f) sign should be installed where a route leaves one Ohio county and enters another Ohio county. On freeways and expressways, the County Line (I-H2h) sign should be installed where a route enters an Ohio county from another Ohio county or another state.*

Option:

- 12 On a conventional road, the External County Line (I-H2g) sign may be installed where a route enters an Ohio county from another state.

Guidance:

- 13 *When used, the External County Line sign should be erected beneath a State Line sign.*

Option:

- 14 The 12 x 12 inch ENTER CORP (I-H2b) and LEAVE CORP (I-H2c) signs may be used instead of the standard size where space is limited.

Table 2H-1. General Information Sign Sizes¹

Sign	Sign Designation	Section	Conventional Road	Freeway or Expressway
Reference Location (1 digit)	D10-1	2H.05	10 x 18	12 x 24
Intermediate Reference Location (2 digits)	D10-1a	2H.05	10 x 27	12 x 36
Reference Location (2 digits)	D10-2	2H.05	10 x 27	12 x 36
Intermediate Reference Location (3 digits)	D10-2a	2H.05	10 x 36	12 x 48
Reference Location (3 digits)	D10-3	2H.05	10 x 36	12 x 48
Intermediate Reference Location (4 digits)	D10-3a	2H.05	10 x 48	12 x 60
Enhanced Reference Location	D10-4	2H.06	18 x 54	18 x 54
Intermediate Enhanced Reference Location	D10-5	2H.06	18 x 60	18 x 60
Ramp Enhanced Reference Location	D10-H5a	2H.06	—	30 x 30
Acknowledgment	D14-1	2H.08	36 x 30 ²	72 x 48 ²
Acknowledgment	D14-2	2H.08	36 x 30 ²	72 x 48 ²
Acknowledgment	D14-3	2H.08	42 x 24 ²	96 x 36 ²
Acknowledgment	D14-H4	2H.08	48 x 30 ²	48 x 30 ²
Signals Set to XX MPH	I1-1	2H.03	24 x 36	—
Jurisdictional Boundary	I-2	2H.04	Varies x 18 ³	Varies x 36 ³
Welcome to Ohio	I-H2	2H.02	60 x 30	—
State Line	E8-H1	2H.02	—	276 x 72
Corporation Limit	I-H2a	2H.02	48 x 24	Varies x 36
ENTER / LEAVE CORP	I-H2b / I-H2c	2H.02	24 x 18	36 x 24
Unincorporated Community	I-H2d	2H.02	48 x 24	—
Township Limit	I-H2e	2H.02	48 x 24	Varies x 36
Internal County	I-H2f	2H.02	48 x 24	—
External County	I-H2g	2H.02	60 x 12	—
County Line	I-H2h	2H.02	—	Varies x 48
Geographical Features	I-3	2H.04	Varies x 18 ³	Varies x 36 ³
Airport	I-5	2H.02	24 x 24	30 x 30
Bus Station	I-6	2H.02	24 x 24	30 x 30
Train Station	I-7	2H.02	24 x 24	30 x 30
Library	I-8	2H.02	24 x 24	30 x 30
Vehicle Ferry Terminal	I-9	2H.02	24 x 24	30 x 30
Recycling Collection Center	I-11	2H.02	30 x 48	—
Light Rail Transit Station	I-12	2H.05	24 x 24	—

Notes:

- Larger signs may be used when appropriate, except for the D14 series signs.
 - Dimensions in inches are shown as width x height.
- The size shown is the maximum size for the corresponding roadway classification. The size of the sign acknowledgement logo should be appropriately reduced where shorter legends are used.
- The size shown is for the typical sign illustrated in the figure. The size should be determined based in the amount of legend required for the sign.

Figure 2H-1. General Information and Miscellaneous Information Signs



Note: For signs discussed in the text but not displayed here, see Appendix C.

Guidance:

- 15 *General information signs should not be installed within a series of guide signs or at other equally critical locations, unless there are specific reasons for orienting the road user or identifying control points for activities that are clearly in the public interest. On all such signs, the designs should be simple and dignified, devoid of any advertising, and in general compliance with other guide signing design principles.*

Standard:

- 16 **Except for political boundary signs, General Information signs shall have white legends and borders on green rectangular-shaped backgrounds.**

Option:

- 17 An information symbol sign (I-5 through I-9) may be used to identify a route leading to a transportation or general information facility, or to provide additional guidance to the facility. The symbol sign may be supplemented by an educational plaque where necessary; also, the name of the facility may be used if needed to distinguish between similar facilities.

- 18 The Advance Turn (M5 series) or Directional Arrow (M6 series) auxiliary signs shown in Figure 2H-1 with white arrows on green backgrounds may be used with General Information symbol signs to create a General Information Directional Assembly.

- 19 Guide signs for commercial service airports and non-carrier airports may be provided from the nearest Interstate, other freeway, or conventional highway intersection directly to the airport, normally not to exceed 15 miles. The Airport (I-5) symbol sign along with a supplemental plaque may be used to indicate the specific name of the airport. An Airport symbol sign, with or without a supplemental name plaque or the word AIRPORT, and an arrow may be used as a trailblazer.

Standard:

- 20 **Adequate trailblazer signs shall be in place prior to installing the airport guide signs.**

Support:

- 21 Location and placement of all airport guide signs depends upon the availability of longitudinal spacing on highways.

Option:

- 22 The Recycling Collection Center (I-11) symbol sign may be used to direct road users to recycling collection centers.

Guidance:

- 23 *The Recycling Collection Center symbol sign should not be used on freeways and expressways.*

Standard:

- 24 **If used on freeways or expressways, the Recycling Collection Center symbol sign shall be considered one of the supplemental sign destinations.**

- 25 **When a sign is used to display a safety or transportation-related message, the display format shall not be of a type that would be considered similar to advertising displays. Messages and symbols that resemble any official traffic control device shall not be used on safety or transportation-related message signs.**

Option:

- 26 The pictograph of a political jurisdiction (such as a State, county, or municipal corporation) may be displayed on a political boundary General Information sign.

Standard:

- 27 **If used, the height of a pictograph on a political boundary General Information sign shall not exceed two times the height of the upper-case letters of the principal legend on the sign. The pictograph shall comply with the provisions of Section 2A.06.**

Section 2H.03 Traffic Signal Speed Sign (I1-1)

Option:

- 01 The Traffic Signal Speed (I1-1) sign (see Figure 2H-1), reading SIGNALS SET FOR XX MPH, may be used to indicate a section of street or highway on which the traffic control signals are coordinated into a progressive system timed for a specified speed at all hours during which they are operated in a coordinated mode.

- 02 If different system progression speeds are set for different times of the day, a changeable message element may be used for the numerals of the Traffic Signal Speed (I1-1) sign. If the system is operated in coordinated mode only during certain times, a blank-out version of the Traffic Signal Speed (I1-1) sign may be used to display the message only during those times.

Guidance:

- 03 *If used, the sign should be mounted as near as practical to each intersection where the timed speed changes, and at intervals of several blocks throughout any section where the timed speed remains constant.*

Standard:

- 04 **The Traffic Signal Speed sign shall be a minimum of 24 x 36 inches with the longer dimension vertical. It shall have a white message and border on a green background.**

Section 2H.04 Miscellaneous Information Signs

Support:

- 01 Miscellaneous information signs are used to point out geographical features, such as rivers and summits, and other jurisdictional boundaries (see Section 2H.02). Figure 2H-1 shows examples of miscellaneous information (I-2 and I-3) signs.

Option:

- 02 Miscellaneous information signs may be used if they do not interfere with signing for interchanges or other critical points.

Guidance:

- 03 *Miscellaneous information signs should not be installed unless there are specific reasons for orienting the road users or identifying control points for activities that are clearly in the public interest. If Miscellaneous information signs are to be of value to the road user, they should be consistent with other guide signs in design and legibility. On all such signs, the design should be simple and dignified, devoid of*

any tendency toward flamboyant advertising, and in general compliance with other signing design principles.

Section 2H.05 Reference Location Signs (D10-1 through D10-3) and Intermediate Reference Location Signs (D10-1a through D10-3a)

Support:

- 01 There are two types of reference location signs:
 - A. Reference Location (D10-1, 2, and 3) signs show an integer distance point along a highway; and
 - B. Intermediate Reference Location (D10-1a, 2a, and 3a) signs also show a decimal between integer distance points along a highway.

Standard:

- 02 **Except when Enhanced Reference Location signs (see Section 2H.06) are used instead, Reference Location (D10-1 through D10-3) signs shall be placed on all expressway facilities that are located on a route where there is reference location sign continuity and on all freeway facilities to assist road users in estimating their progress, to provide a means for identifying the location of emergency incidents and traffic crashes, and to aid in highway maintenance and servicing.**

Option:

- 03 Reference Location (D10-1 to D10-3) signs (see Figure 2H-2) may be installed along any section of a highway route or ramp to assist road users in estimating their progress, to provide a means for identifying the location of emergency incidents and traffic crashes, and to aid in highway maintenance and servicing.

- 04 To augment the reference location sign system, Intermediate Reference Location (D10-1a to D10-3a) signs (see Figure 2H-3), which show the tenth of a mile with a decimal point, may be installed at one tenth of a mile intervals, or at some other regular spacing.

Standard:

- 05 **When Intermediate Reference Location (D10-1a to D10-3a) signs are used to augment the reference location sign system, the reference location sign at the integer mile point shall display a decimal point and a zero numeral.**

- 06 **When placed on freeways or expressways, reference location signs shall contain 10-inch white numerals on a 12-inch wide green background with a white border. The signs shall be 24, 36, or 48 inches in height for one, two, or three digits, respectively, and shall contain the word MILE in 4-inch white letters.**

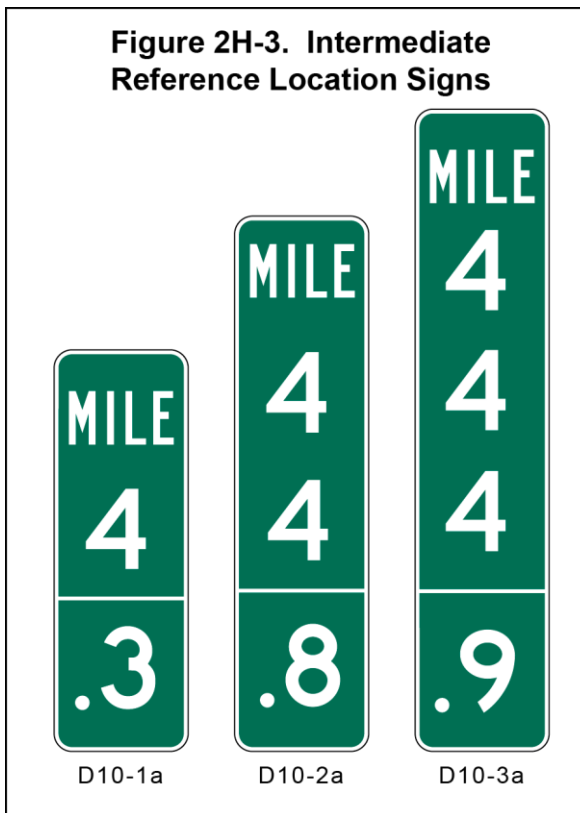
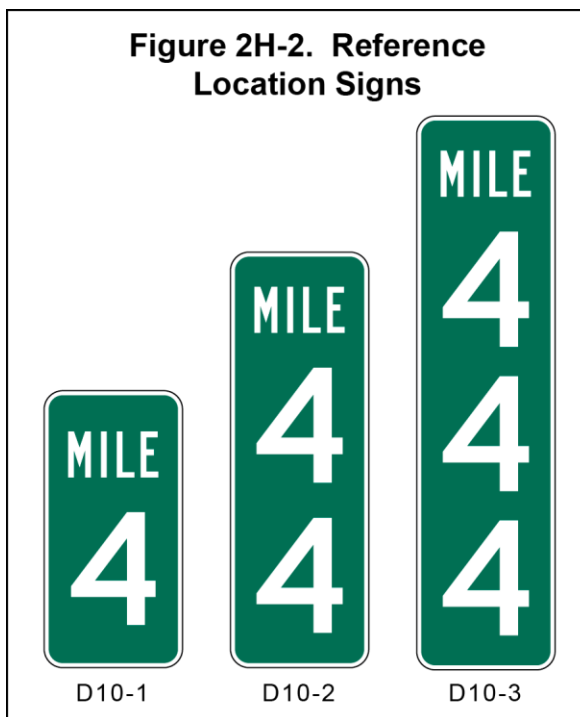

07 **When placed on conventional roads, reference location signs shall contain 6-inch white numerals on a green background that is at least 10 inches wide with a white border. The signs shall contain the word MILE in 4-inch white letters.**

08 **Reference location signs shall have a minimum mounting height of 4 feet, measured vertically from the bottom of the sign to the elevation of the near edge of the roadway, and shall not be governed by the mounting height requirements prescribed in Section 2A.18.**

09 **The distance numbering shall be continuous for each route within a State, except where overlaps occur (see Section 2E.31). Where routes overlap, reference location sign continuity shall be established for only one of the routes. If one of the overlapping routes is an Interstate route, that route shall be selected for continuity of distance numbering.**

Guidance:

10 *The route selected for continuity of distance numbering should also have continuity in interchange exit numbering (see Section 2E.31).*

11 *On a route without reference location sign continuity, the first reference location sign beyond the overlap should indicate the total distance traveled on the route so that road users will have a means of correlating their travel distance between reference location signs with that shown on their odometer.*

Standard:

12 **For divided highways, the distance measurement shall be made on the northbound and eastbound roadways. The reference location signs for southbound or westbound roadways shall be set at locations directly opposite the reference location signs for the northbound or eastbound roadways.**

Guidance:

13 *Zero distance should begin at the south and west State lines, or at the south and west terminus points where routes begin within a State.*

Standard:

14 **Except as provided in Paragraph 15, reference location signs shall be installed on the right-hand side of the roadway.**

Option:

15 *Where conditions limit or restrict the use of reference location signs on the right-hand side of the roadway, they may be installed in the median. On two-lane conventional roadways, reference location signs may be installed on one side of the roadway only and may be installed back-to-back. Reference location signs may be placed up to 30 feet from the edge of the pavement.*

16 *If a reference location sign cannot be installed in the correct location, it may be moved in either direction as much as 50 feet.*

Guidance:

17 *If a reference location sign cannot be placed within 50 feet of the correct location, it should be omitted.*

Section 2H.06 Enhanced Reference Location Signs (D10-4, D10-5, D10-H5a)

Support:

01 There are three types of enhanced reference location signs:

- A. Enhanced Reference Location signs (D10-4),
- B. Intermediate Enhanced Reference Location signs (D10-5), and
- C. Ramp Enhanced Reference Location signs (D10-H5a).

Option:

02 *Enhanced Reference Location (D10-4) signs (see Figure 2H-4), which enhance the reference location sign system by identifying the route, may be placed on freeways or expressways (instead of Reference Location signs) or on conventional roads.*

03 *To augment an enhanced reference location sign system, Intermediate Enhanced Reference Location (D10-5) signs (see Figure 2H-4), which show the tenth of a mile with a decimal point, may be installed along any section of a highway route or ramp at one tenth of a mile intervals, or at some other regular spacing.*

04 *Ramp Enhanced Reference Location (D10-H5a) signs, which indicate the names of the routes being connected, may be installed along any ramp.*

- 05 If enhanced reference location signs are used, they shall be vertical signs having a blue background with white numerals, letters, and borders, except for the route shield, which shall be the standard color and shape. The top line shall consist of the cardinal direction for the roadway. The second line shall consist of the applicable route shield for the roadway. The third line shall identify the mile reference for the location and the bottom line of the Intermediate Enhanced Reference Location sign shall give the tenth of a mile reference for the location. The bottom line of the Intermediate Enhanced Reference Location sign shall contain a decimal point. The height of the legend on enhanced reference location signs shall be a minimum of 6 inches. The height of the route shield on enhanced reference location signs shall be a minimum of 12 inches.

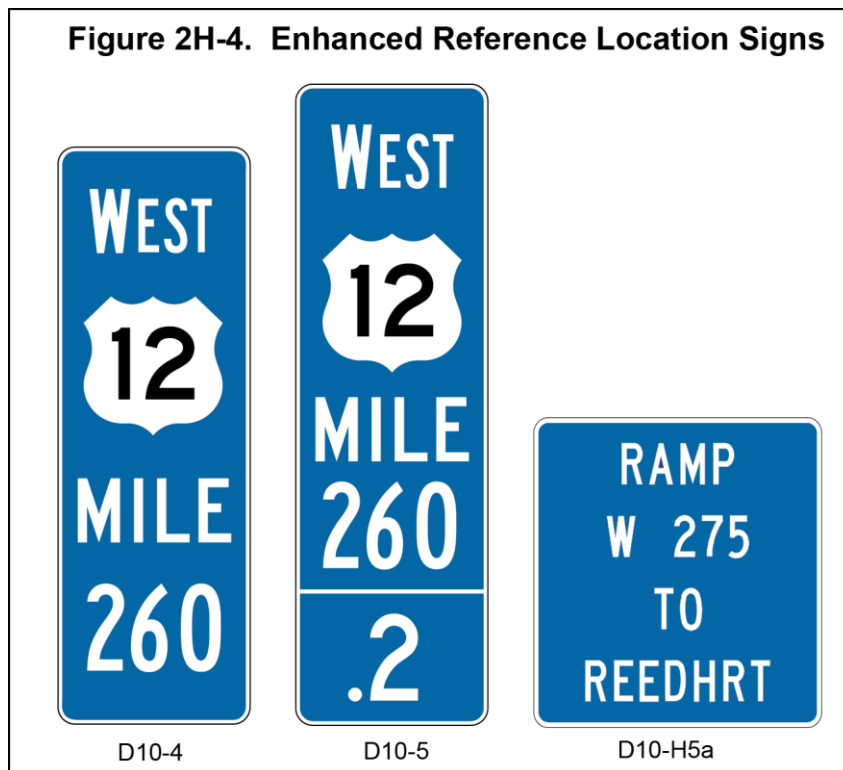

Support:

- 06 The provisions in Section 2H.05 regarding mounting height, distance numbering and measurements, sign continuity, and placement with respect to the right-hand shoulder and/or median for reference location signs also apply to enhanced reference location signs.

Section 2H.07 Auto Tour Route Signs

Support:

- 01 Auto Tour Route signs are informational signs, plaques, or shields designed to provide road users with route guidance in following an auto tour route of particular cultural, historical, or educational significance.
- 02 Signed auto tour routes are used in some cases to generally follow the historical route of a trail, such as the National Historic Trails administered by the National Park Service. Examples include auto tour routes that parallel the Lewis and Clark National Historic Trail, the Oregon National Historic Trail, and the Santa Fe National Historic Trail. Part 2 of ODOT's "Traffic Engineering Manual" (see Section 1A.11) includes information about similar routes, such as the Great Lakes Circle Tour.

Guidance:

- 03 If shields or other similar signs are used to provide route guidance in following an auto tour route, they should be designed in accordance with the sizes and other design principles for route signs, such as those described in Sections 2D.10 through 2D.12.

Option:

- 04 Auto Tour Route signs may be installed on a highway if they have been approved by the appropriate transportation agency.

Standard:

- 05 Auto Tour Route signs shall not be installed on freeways or expressways, except as necessary to provide continuity between discontinuous segments of conventional roadways that are designated as auto tour routes, for which the freeway or expressway provides the only connection between the segments. If installed on freeways or expressways, Auto Tour Route signs shall be installed as independent trailblazer assemblies (see Sections 2D.35 and 2E.27) and shall not be installed with other

Route signs or confirmation assemblies or on guide signs. If installed on freeways or expressways, Auto Tour Route trailblazer assemblies shall be installed at less frequent intervals than route confirmation assemblies.

Section 2H.08 Acknowledgment Signs

Support:

01 Acknowledgment signs are a way of recognizing a company, business, or volunteer group that provides a highway-related service. Acknowledgment signs include sponsorship signs for adopt-a-highway litter removal programs, maintenance of a parkway or interchange, and other highway maintenance or beautification sponsorship programs.

Guidance:

02 *Highway agency that elects to have an acknowledgment sign program should develop an acknowledgment sign policy. The policy should require that eligible sponsoring organizations comply with State laws prohibiting discrimination based on race, religion, color, age, sex, national origin, and other applicable laws. The acknowledgment sign policy should include all of the provisions regarding sign placement and sign design that are described in this Section.*

Standard:

03 **Because regulatory, warning, and guide signs have a higher priority, acknowledgment signs shall only be installed where adequate spacing is available between the acknowledgment sign and other higher priority signs. Acknowledgment signs shall not be installed in a position where they would obscure the road users' view of other traffic control devices.**

04 **Acknowledgment signs shall not be installed at any of the following locations:**

- A. **On the front or back of, adjacent to, or around any other traffic control device, including traffic signs, highway traffic signals, and changeable message signs;**
- B. **On the front or back of, adjacent to, or around the supports or structures of other traffic control devices, or bridge piers; or**
- C. **At key decision points where a road user's attention is more appropriately focused on other traffic control devices, roadway geometry, or traffic conditions, including exit and entrance ramps, intersections, grade crossings, toll plazas, temporary traffic control zones, and areas of limited sight distance.**

Guidance:

05 *The minimum spacing between acknowledgment signs and any other traffic control signs, except parking regulation signs, should be:*

- A. *150 feet on roadways with speed limits of less than 30 mph,*
- B. *200 feet on roadways with speed limits of 30 to 45 mph, and*
- C. *500 feet on roadways with speed limits greater than 45 mph.*

06 *If the placement of a newly-installed higher-priority traffic control device, such as a higher-priority sign, a highway traffic signal, or a temporary traffic control device, conflicts with an existing acknowledgment sign, the acknowledgment sign should be relocated, covered, or removed.*

Option:

07 Highway agencies may develop their own acknowledgment sign designs and may also use their own pictograph (see definition in Section 1A.13) and/or a brief jurisdiction-wide program slogan as part of any portion of the acknowledgment sign, provided that the signs comply with the provisions for shape, color, and lettering style in this Chapter and in Chapter 2A.

Guidance:

08 *Acknowledgment signs should clearly indicate the type of highway services provided by the sponsor.*

Standard:

09 **In addition to the general provisions for signs described in Chapter 2A and the sign design principles covered in the "Sign Designs and Markings Manual" (SDMM) (see Section 1A.11), acknowledgment sign designs developed by highway agencies shall comply with the following provisions:**

- A. Neither the sign design nor the sponsor acknowledgment logo shall contain any contact information, directions, slogans (other than a brief jurisdiction-wide program slogan, if used), telephone numbers, or Internet addresses, including domain names and uniform resource locators (URL);
- B. Except for the lettering, if any, on the sponsor acknowledgment logo, all of the lettering shall be in upper-case letters as provided in the SDMM book (see Section 1A.11);
- C. In order to keep the main focus on the highway-related service and not on the sponsor acknowledgment logo, the area reserved for the sponsor acknowledgment logo shall not exceed 1/3 of the total area of the sign and shall be a maximum of 8 square feet, and shall not be located at the top of the sign;
- D. The entire sign display area shall not exceed 24 square feet;
- E. The sign shall not contain any messages, lights, symbols, or trademarks that resemble any official traffic control devices;
- F. The sign shall not contain any external or internal illumination, light-emitting diodes, luminous tubing, fiber optics, luminescent panels, or other flashing, moving, or animated features; and
- G. The sign shall not distract from official traffic control messages such as regulatory, warning, or guidance messages.

Support:

10 Examples of acknowledgment sign designs are shown in Figure 2H-5.

Figure 2H-5. Examples of Acknowledgment Sign Designs



D14-1



D14-2



D14-3



D14-H4

Intentionally blank

CHAPTER 2I. GENERAL SERVICE SIGNS

Section 2I.01 Sizes of General Service Signs

Standard:

- 01 Except as provided in Section 2A.11, the sizes of General Service signs that have a standardized design shall be as shown in Table 2I-1 and the “Sign Designs and Markings Manual” (SDMM) (see Section 1A.11).

Support:

- 02 Section 2A.11 contains information regarding the applicability of the various columns in Table 2I-1.

Option:

- 03 Signs larger than those shown in Table 2I-1 may be used (see Section 2A.11).

Table 2I-1. General Service Sign and Plaque Sizes¹ (Sheet 1 of 2)

Sign or Plaque	Sign Designation	Section	Conventional Road	Freeway or Expressway
Rest Area XX Miles	D5-H1	2I.05	72 x 36 ²	120 x 60 ²
Rest Area Next Right	D5-H1a	2I.05	72 x 36 ²	120 x 60 ²
Rest Area (with arrow)	D5-H2	2I.05	72 x 36 ²	120 x 60 ²
Rest Area Gore	D5-H2a	2I.05	42 x 48 ²	72 x 72 ²
Rest Area (with horizontal arrow)	D5-5	2I.05	42 x 48 ²	—
Next Rest Area XX Miles	D5-6	2I.05	60 x 48 ²	96 x 72 ²
Rest Area Tourist Info Center XX Miles	D5-H7	2I.08	84 x 72 ²	144 x 96 ²
Rest Area Tourist Info Center (with arrow)	D5-H8	2I.08	84 x 72 ²	144 x 96 ²
Rest Area Tourist Info Center Next Right	D5-H11	2I.08	84 x 72 ²	144 x 96 ²
Interstate Oasis	D5-12	2I.04	—	156 x 78
Interstate Oasis (plaque)	D5-12P	2I.04	—	114 x 48
Brake Check Area XX Miles	D5-13	2I.06	84 x 48	126 x 72
Brake Check Area (with arrow)	D5-14	2I.06	78 x 60	96 x 72
Chain-Up Area XX Miles	D5-15	2I.07	66 x 48	96 x 72
Chain-Up Area (with arrow)	D5-16	2I.07	72 x 54	96 x 66
Telephone	D9-1	2I.02	24 x 24	30 x 30
Hospital	D9-2	2I.02	24 x 24	30 x 30
Camping	D9-3	2I.02	24 x 24	30 x 30
Trailer Camping	D9-3a	2I.02	24 x 24	30 x 30
Litter Container	D9-4	2I.02	24 x 30	36 x 48
Handicapped	D9-6	2I.02	24 x 24	30 x 30
Van Accessible (plaque)	D9-6P	2I.02	18 x 9	—
Gas	D9-7	2I.02	24 x 24	30 x 30
Food	D9-8	2I.02	24 x 24	30 x 30
Lodging	D9-9	2I.02	24 x 24	30 x 30
Tourist Information	D9-10	2I.02	24 x 24	30 x 30
Diesel Fuel	D9-11	2I.02	24 x 24	30 x 30
Alternative Fuel – Compressed Natural Gas	D9-11a	2I.02	24 x 24	30 x 30

































Table 2I-1. General Service Sign and Plaque Sizes¹ (Sheet 2 of 2)

Sign or Plaque	Sign Designation	Section	Conventional Road	Freeway or Expressway
Electric Vehicle Charging	D9-11b	2I.02	24 x 24	30 x 30
Electric Vehicle Charging (plaque)	D9-11bP	2I.02	24 x 18	30 x 24
Alternative Fuel – Ethanol	D9-11c	2I.02	24 x 24	30 x 30
RV Sanitary Station	D9-12	2I.02	24 x 24	30 x 30
Emergency Medical Services	D9-13	2I.02	24 x 24	30 x 30
Hospital (plaque)	D9-13aP	2I.02	24 x 12	30 x 12
Ambulance Station (plaque)	D9-13bP	2I.02	24 x 12	30 x 15
Emergency Medical Care (plaque)	D9-13cP	2I.02	24 x 18	30 x 24
Trauma Center (plaque)	D9-13dP	2I.02	24 x 12	30 x 15
Police	D9-14	2I.02	24 x 24	30 x 30
Propane Gas	D9-15	2I.02	24 x 24	30 x 30
Truck Parking	D9-16	2I.02	24 x 24	30 x 30
Next Services XX Miles (plaque)	D9-17P	2I.02	102 x 24	156 x 30
General Services (up to 6 symbols)	D9-18	2I.03	—	96 x 60
General Services	D9-18a	2I.03	—	96 x 60
General Services (up to 6 symbols) with Action or Exit Information	D9-18b	2I.03	108 x 84	132 x 114 (F) 132 x 108 (E)
General Services with Action or Exit Information	D9-18c	2I.03	72 x 60 ³	132 x 108 ³ (F) 108 x 84 ³ (E)
Telecommunication Device for the Deaf	D9-21	2I.05	24 x 24	30 x 30
Wireless Internet	D9-22	2I.05	24 x 24	30 x 30
Weather Information	D12-1	2I.09	84 x 48	132 x 84
Carpool Information	D12-2	2I.11	60 x 42	96 x 66
Channel 9 Monitored	D12-3	2I.09	84 x 48	132 x 84
Emergency Call 911	D12-4	2I.09	66 x 30	96 x 48
Travel Info Call 511 (pictograph)	D12-5	2I.10	42 x 60	66 x 78
Travel Info Call 511	D12-5a	2I.10	48 x 36	66 x 48

Notes:

1. a.) Larger signs may be used when appropriate.
b.) Dimensions in inches are shown as width x height.
c.) Where two sizes are shown, the larger size is for freeways (F) and the smaller size is for expressways (E).
2. The size shown is for a sign with a REST AREA and/or TOURIST INFO CENTER legend. The size may need to be adjusted if an alternate legend is used. Refer to the Sign Designs and Markings Manual (SSDM) for designs using alternate legends.
3. The size shown is for a sign with four lines of service. The size should be appropriately adjusted depending on the amount of legend displayed.

Figure 2I-1. General Service Signs and Plaques

					
D9-1 Telephone	D9-2 Hospital	D9-3 Camping	D9-3a Trailer Camping	D9-4 Litter Container	D9-6 Handicapped
					
D9-6P VAN ACCESSIBLE	D9-7 Gas	D9-8 Food	D9-9 Lodging	D9-10 Tourist Information	D9-11 Diesel Fuel
					
D9-11a Alternative Fuel- Compressed Natural Gas	D9-11b Electric Vehicle Charging	D9-11bP Electric Vehicle Charging	D9-11c Alternative Fuel- Ethanol	D9-12 RV Sanitary Station	D9-13 Emergency Medical Services
					
D9-13aP Hospital	D9-13bP Ambulance Station	D9-13cP Emergency Medical Care	D9-13dP Trauma Center	D9-14 Police	D9-15 Propane Gas
					
	D9-16 Truck Parking	D9-21 Telecommunication Device for the Deaf	D9-22 Wireless Internet		
Advance Turn and Directional Arrow Auxiliary Signs for use with General Service Signs					
					
M5-1	M5-2	M6-1	M6-2	M6-3	Example of directional assembly

Section 2I.02 General Service Signs for Conventional Roads

Support:

01 On conventional roads, commercial services such as gas, food, and lodging generally are within sight and are available to the road user at reasonably frequent intervals along the route. Consequently, on this class of road there usually is no need for special signs calling attention to these services. Moreover, General Service signing is usually not required in urban areas except for hospitals, law enforcement assistance, tourist information centers, and camping.

Option:

02 General Service signs (see Figure 2I-1) may be used where such services are infrequent and are found only on an intersecting highway or crossroad.

Standard:

03 **All General Service signs and supplemental sign panels shall have white letters, symbols, arrows, and borders on a blue background.**

Guidance:

04 *General Service signs should be installed at a suitable distance in advance of the turn-off point or intersecting highway.*

05 *In addition to the information in this Manual, for the sake of uniformity local jurisdictions electing to use General Service signing should follow the related standards and guidelines established in Part 2 of the ODOT "Traffic Engineering Manual" (see Section 1A.11).*

Option:

06 Signs may be installed for whatever alternative fuels are available at appropriate locations.

Standard:

07 **General Service signs, if used at intersections, shall be accompanied by a directional message.**

Option:

08 The Advance Turn (M5 series) or Directional Arrow (M6 Series) auxiliary signs with white arrows on blue backgrounds as shown in Figure 2I-1 may be used with General Service symbol signs to create a General Service Directional Assembly.

09 The General Service sign legends may be either symbols or word messages.

Standard:

10 **Symbols and word message General Service legends shall not be intermixed on the same sign.**

Support:

11 Formats for displaying different combinations of these services are described in Section 2I.03.

Option:

12 If the distance to the next point at which services are available is 10 miles or more, a sign NEXT SERVICES XX MILES (D9-17P) plaque (see Figure 2I-2) may be installed below the General Service sign.

13 The International Symbol of Accessibility for the Handicapped (D9-6) sign may be used beneath General Service signs where paved ramps and rest room facilities accessible to, and usable by, the physically handicapped are provided.

Guidance:

14 *When the D9-6 sign is used in accordance with Paragraph 13, and van-accessible parking is available at the facility, a VAN ACCESSIBLE (D9-6P) plaque (see Figure 2I-1) should be mounted below the D9-6 sign.*

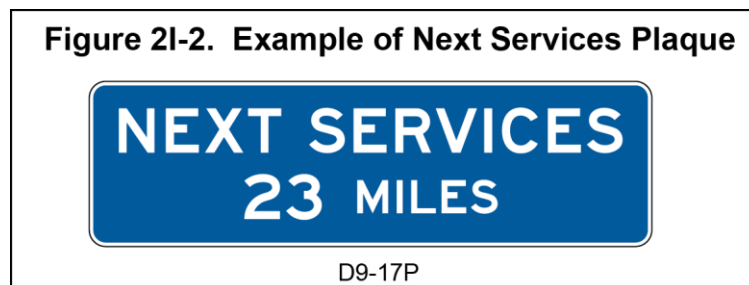

15 The Recreational Vehicle Sanitary Station (D9-12) sign may be used as needed to indicate the availability of facilities designed for the use of dumping wastes from recreational vehicle holding tanks.

16 The Litter Container (D9-4) sign may be placed in advance of roadside turnouts or rest areas, unless it distracts the driver's attention from other more important regulatory, warning, or directional signs.

17 The Emergency Medical Services (D9-13) symbol sign may be used to identify medical service facilities that have been included in the Emergency Medical Services system under a signing policy developed by the State and/or local highway agency.

Standard:

18 **The Emergency Medical Services symbol sign shall not be used to identify services other than qualified hospitals, ambulance stations, and qualified free-standing emergency medical treatment centers. If used, the Emergency Medical Services symbol sign shall be supplemented by a sign identifying the type of service provided.**

Option:

19 The Emergency Medical Services symbol sign may be used above the HOSPITAL (D9-13aP) plaque or Hospital (D9-2) symbol sign or above a plaque with the legend AMBULANCE STATION (D9-13bP), EMERGENCY MEDICAL CARE (D9-13cP), or TRAUMA CENTER (D9-13dP). The Emergency Medical Services symbol sign may also be used to supplement Telephone (D9-1), Channel 9 Monitored (D12-3), or POLICE (D9-14) signs.

Standard:

20 **The legend EMERGENCY MEDICAL CARE shall not be used for services other than qualified free-standing emergency medical treatment centers.**

Guidance:

21 *Each highway agency electing to use the Emergency Medical Services symbol sign should follow the related standards and guidelines established in Part 2 of the ODOT "Traffic Engineering Manual" (see Section 1A.11).*

Section 2I.03 General Service Signs for Freeways and Expressways

Support:

01 General Service (D9-18 series) signs (see Figure 2I-3) are generally not appropriate at major interchanges (see definition in Section 2E.32) and in urban areas.

02 Additional information regarding the use of General Service signs on state highways is located in Part 2 of the ODOT "Traffic Engineering Manual" (see Section 1A.11).

Standard:

03 **General Service signs shall have white letters, symbols, arrows, and borders on a blue background. Letter and numeral sizes shall comply with the minimum requirements of Tables 2E-2 and 2E-3 and the designs provided in the SDMM (see Section 1A.11). All approved symbols shall be permitted as alternatives to word messages, but symbols and word service messages shall not be intermixed. If the services are not visible from the ramp of a single-exit interchange, the service signing shall be repeated in smaller size at the intersection of the exit ramp and the crossroad. Such service signs shall use arrows to indicate the direction to the services.**

Option:

04 For numbered interchanges, the exit number may be incorporated within the sign legend (D9-18b) or displayed on an Exit Number (E1-H5P) plaque (see Section 2E.31).

Guidance:

05 *Distance to services should be displayed on General Service signs where distances are more than 1 mile.*

06 *General Service signing should only be provided at locations where the road user can return to the freeway or expressway and continue in the same direction of travel.*

Figure 2I-3. Examples of General Service Signs with and without Exit Numbering

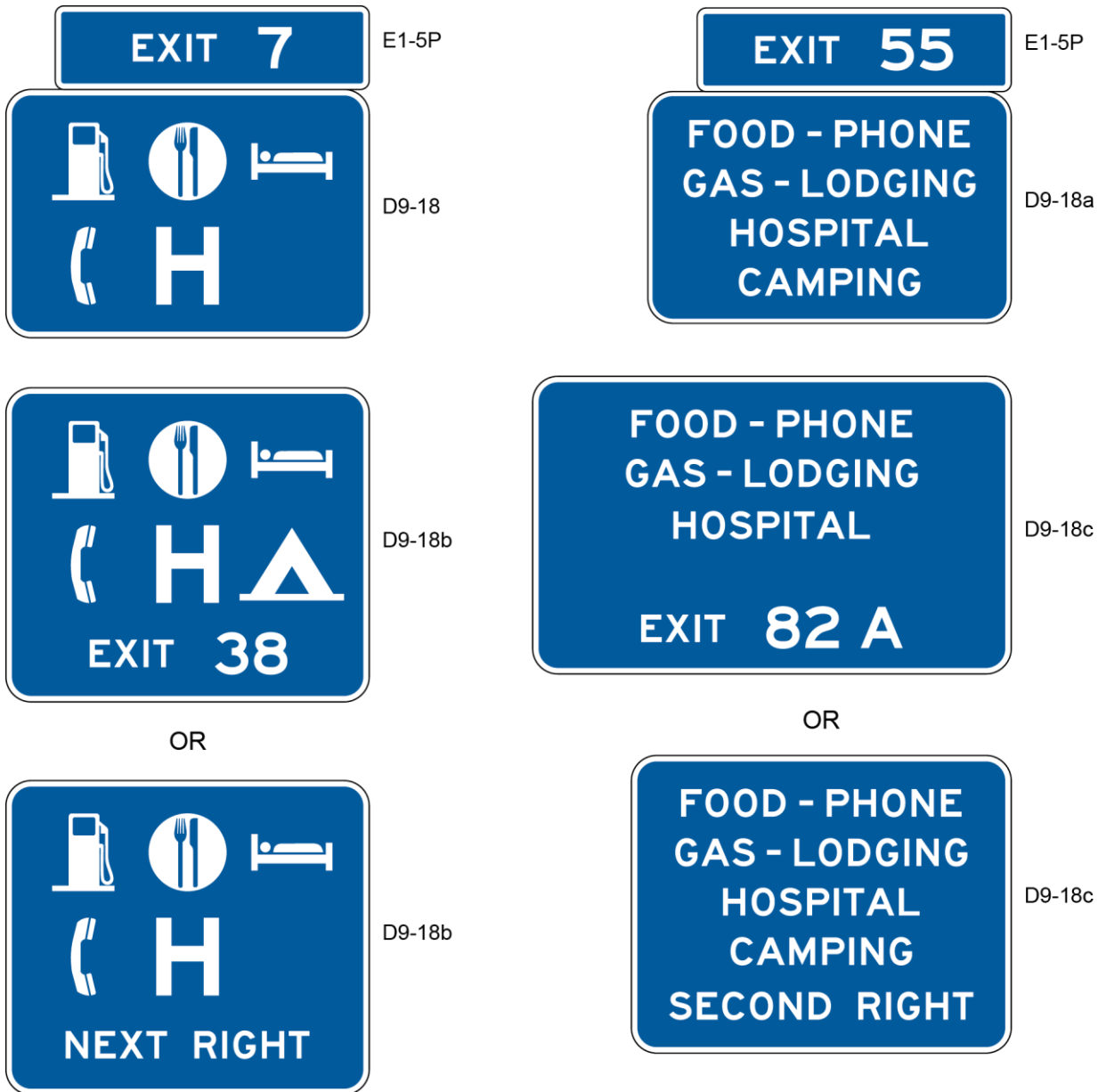

07 *Only services that fulfill the needs of the road user should be displayed on General Service signs. Each highway agency that elects to provide General Service signing should establish a policy for such signing, similar to that published by ODOT in the "Traffic Engineering Manual" (see Section 1A.11).*

Standard:

08 **For any service that is operated on a seasonal basis only, the General Service signs shall be removed or covered during periods when the service is not available.**

09 **The General Service signs shall be mounted in an effective location, between the Advance Guide sign and the Exit Direction sign, in advance of the exit leading to the available services.**

Guidance:

10 *The General Service sign should contain the interchange number, if any, as shown in Figure 2I-3.*

Option:

11 **If the distance to the next point where services are available is greater than 10 miles, a NEXT SERVICES XX MILES (D9-17P) plaque (see Figure 2I-2), may be installed below the Exit Direction sign.**

Standard:

12 **Signs for services shall comply with the format for General Service signs (see Section 2I.02) and as provided in this Manual. No more than six general road user services shall be displayed on one sign, which includes any appended supplemental signs or plaques. General Service signs shall carry the legends for one or more of the following services: Food, Gas, Lodging, Camping, Phone, Hospital, or Tourist Information.**

13 **The qualified services available shall be displayed at specific locations on the sign.**

14 **To provide flexibility for the future when the service might become available, the sign space normally reserved for a given service symbol or word shall be left blank when that service is not present.**

Guidance:

15 *The standard display of word messages should be FOOD and PHONE in that order on the top line, and GAS and LODGING on the second line. If used, HOSPITAL and CAMPING should be on separate lines (see Figure 2I-3).*

Option:

16 Signing for DIESEL, LP-Gas, or other alternative fuel services may be substituted for any of the general services or appended to such signs. The International Symbol of Accessibility for the Handicapped (D9-6) sign (see Figure 2I-1) may be used for facilities that qualify.

Guidance:

17 *When symbols are used for the road user services, they should be displayed as follows:*

A. Six services:

1. *Top row—GAS, FOOD, and LODGING*
2. *Bottom row—PHONE, HOSPITAL, and CAMPING*

B. Four services:

1. *Top row—GAS and FOOD*
2. *Bottom row—LODGING and PHONE*

C. Three services:

1. *Top row—GAS, FOOD, and LODGING*

Option:

18 Substitutions of other services for any of the services described in Paragraph 17 may be made by placing the substitution in the lower right (four or six services) or extreme right (three services) portion of the sign. An action message or an interchange number may be used for symbol signs in the same manner as they are used for word message signs. The Diesel Fuel (D9-11) symbol or the LP-Gas (D9-15) symbol may be substituted for the symbol representing fuel or appended to such assemblies. The Information (D9-10) symbol may be substituted on any of the configurations provided in Paragraph 17.

19 At rural interchange areas where limited road user services are available and where it is unlikely that additional services will be provided within the near future, a supplemental plaque displaying one to three services (words or symbols) may be appended below a post-mounted interchange guide sign.

Standard:

20 **If more than three services become available at rural interchange areas where limited road user services were anticipated, the appended supplemental plaque described in Paragraph 19 shall be removed and replaced with an independently mounted General Service sign as described in this Section.**

Option:

21 A separate Telephone Service (D9-1) sign (see Figure 2I-1) may be installed if telephone facilities are located adjacent to the route at places where public telephones would not normally be expected.

22 The Recreational Vehicle Sanitary Station (D9-12) sign (see Figure 2I-1) may be used as needed to indicate the availability of facilities designed for dumping wastes from recreational vehicle holding tanks.

23 In some locations, signs may be used to indicate that services are not available.

- 24 A separate Truck Parking (D9-16) sign (see Figure 2I-1) may be mounted below the other general road user services to direct truck drivers to designated parking areas.

Section 2I.04 Interstate Oasis Signing

Support:

- 01 An Interstate Oasis is a facility near an Interstate highway that provides products and services to the public, 24-hour access to public restrooms, and parking for automobiles and heavy trucks. Interstate Oasis guide signs inform road users on Interstate highways as to the presence of an Interstate Oasis at an interchange and which businesses have been designated by the State within which they are traveling as having met the eligibility criteria of the Federal Highway Administration's Interstate Oasis policy. The FHWA's policy, which is dated October 18, 2006, and which can be viewed on the MUTCD website at <http://mutcd.fhwa.dot.gov/res-policy.htm>, provides a more detailed definition of an Interstate Oasis and specifies the eligibility criteria for an Interstate Oasis designation in compliance with the requirements of laws enacted by Congress.

- 02 At the time of publication of this Manual, Ohio does not have any "Interstate Oasis" facilities.

Section 2I.05 Rest Area and Other Roadside Area Signs

Standard:

- 01 **Rest Area signs (see Figure 2I-5 and Appendix C) shall have a retroreflective white legend and border on a blue background.**

- 02 **Signs that include the legend REST AREA shall be used only where parking and restroom facilities are available.**

Guidance:

- 03 *A roadside area that does not contain restroom facilities should be signed to indicate the major road user service that is provided. For example, the sign legends for an area with only parking should use the words PARKING AREA instead of REST AREA. The sign legends for an area with only picnic tables and parking should use words such as PICNIC AREA, ROADSIDE TABLE, or ROADSIDE PARK instead of REST AREA.*

- 04 *Rest areas that have tourist information and welcome centers should be signed as discussed in Section 2I.08.*

- 05 *Scenic area signing should be consistent with that provided for rest areas, except that legends should use words such as SCENIC AREA, SCENIC VIEW, or SCENIC OVERLOOK, instead of REST AREA.*

- 06 *If a rest area or other roadside area is provided on a conventional road, a D5-H1 and/or D5-H1a sign should be installed in advance of the rest area or other roadside area to permit the driver to reduce speed in preparation for leaving the highway. A D5-5 sign (or a D5-H2 sign if an exit ramp is provided) should be installed at the turnoff point where the driver needs to leave the highway to access the rest area or other roadside area.*

Figure 2I-4. Examples of Interstate Oasis Signs and Plaques

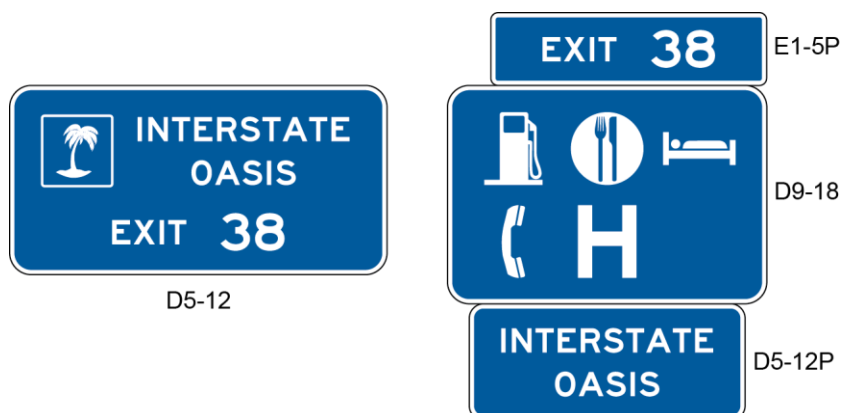
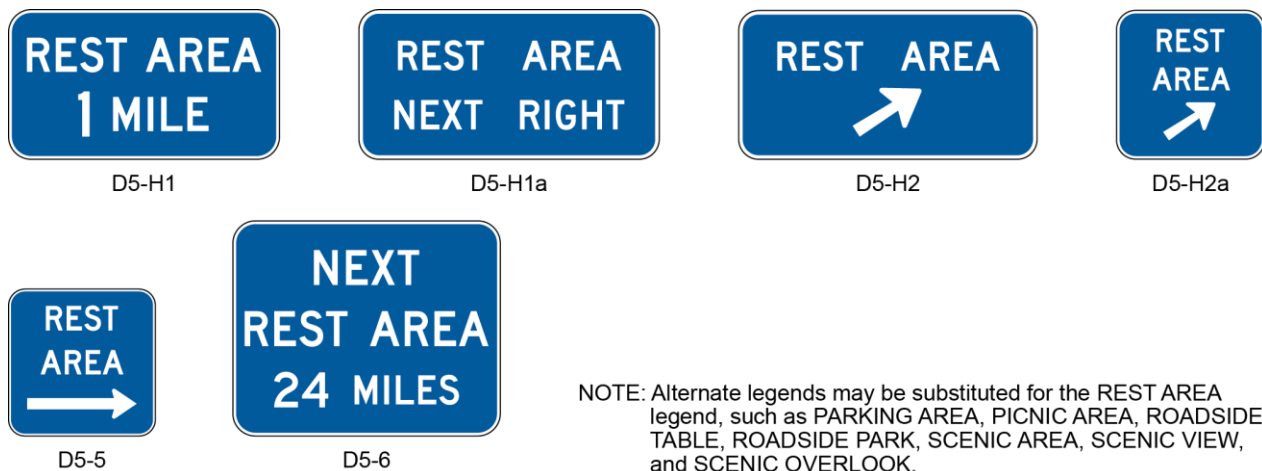

Figure 2I-5. Rest Area and Other Roadside Area Signs

- 07 *If a rest area or other roadside area is provided on a freeway or expressway, a D5-H1 should be placed 1 mile and/or 2 miles in advance of the rest area.*

Standard:

- 08 **A D5-H2a sign shall be placed at the rest area or other roadside area exit gore.**

Option:

- 09 A D5-H1a sign may be placed between the D5-H1 sign and the exit gore on a freeway or expressway. A second D5-H1 sign may be used in place of the D5-H1a sign with a distance to the nearest 1/2 or 1/4 mile displayed as a fraction rather than a decimal for distances of less than 1 mile.

- 10 To provide the road user with information on the location of succeeding rest areas, a NEXT REST AREA XX MILES (D5-6) sign (see Figure 2I-5) may be installed independently, or as a supplemental sign mounted below one of the REST AREA advance guide signs.

Standard:

- 11 **All signs on freeways and expressways for rest and other roadside areas shall have letter and numeral sizes that comply with the minimum requirements of Tables 2E-2 and 2E-3 and the SDMM. The sizes for General Service signs that have standardized designs shall be as shown in Table 2I-1 and the SDMM.**

Option:

- 12 If the rest area has facilities for the physically impaired (see Section 2I.02), the International Symbol of Accessibility for the Handicapped (D9-6) sign (see Figure 2I-1) may be placed with or beneath the REST AREA advance guide sign.

- 13 If telecommunication devices for the deaf (TDD) are available at the rest area, the TDD (D9-21) symbol sign (see Figure 2I-1) may be used to supplement the advance guide signs for the rest area.

- 14 If wireless Internet services are available at the rest area, the Wi-Fi (D9-22) symbol sign (see Figure 2I-1) may be used to supplement the advance guide signs for the rest area.

Section 2I.06 Brake Check Area Signs (D5-13, D5-14)**Guidance:**

- 01 *If an area has been provided for drivers to check the brakes on their vehicle, a BRAKE CHECK AREA XX MILES (D5-13) sign (see Figure 2I-6) should be installed in advance of the brake check area, and a D5-14 sign (see Figure 2I-6) should be placed at the entrance to the brake check area.*

Figure 2I-6. Brake Check Area and Chain-Up Area Signs**Section 2I.07 Chain-Up Area Signs (D5-15, D5-16)***Guidance:*

- 01 If an area has been provided for drivers to pull off of the roadway to install chains on their tires, a CHAIN-UP AREA XX MILES (D5-15) sign (see Figure 2I-6) should be installed in advance of the chain-up area, and a D5-16 sign (see Figure 2I-6) should be placed at the entrance to the chain-up area.

Section 2I.08 Tourist Information and Welcome Center Signs*Support:*

- 01 Tourist information and welcome centers have been constructed within some rest areas on freeways and expressways and are operated by either a State or a private organization. Others have been located within close proximity to these facilities and operated by civic clubs, chambers of commerce, or private enterprise.

Guidance:

- 02 An excessive number of supplemental sign panels should not be installed with Tourist Information or Welcome Center signs so as not to overload the road user.

Standard:

- 03 Tourist Information or Welcome Center signs (see Figure 2I-7) shall have a white legend and border on a blue background. Continuously staffed or unstaffed operation at least 8 hours per day, 7 days per week, shall be required.

- 04 If operated only on a seasonal basis, the Tourist Information or Welcome Center signs shall be removed or covered during the off seasons.

Guidance:

- 05 For freeway or expressway rest area locations that also serve as tourist information or welcome centers, the following signing criteria should be used:
- The locations for tourist information and welcome center Advance Guide, Exit Direction, and Exit Gore signs should meet the General Service signing requirements described in Section 2I.03.
 - If the signing for the tourist information or welcome center is to be accomplished in conjunction with the initial signing for the rest areas, the message on the Advance Guide (D5-H7) sign should be REST AREA, TOURIST INFO CENTER, XX MILES or REST AREA, OHIO (optional) WELCOME CENTER XX MILES. On the Exit Direction (D5-H8 or D5-H11) sign the message should be REST AREA, TOURIST INFO CENTER with a diagonally upward-pointing directional arrow (or NEXT RIGHT), or REST AREA, OHIO (optional), WELCOME CENTER with a diagonally upward-pointing directional arrow (or NEXT RIGHT).
 - If the initial rest area Advance Guide and Exit Direction signing is in place, these signs should include, on supplemental signs, the legend TOURIST INFO CENTER or OHIO (optional), WELCOME CENTER.
 - The Exit Gore sign should contain only the legend REST AREA with the arrow and should not be supplemented with any legend pertaining to the tourist information center or welcome center.

Option:

- 06 An alternative to the supplemental TOURIST INFO CENTER legend is the Tourist Information (D9-10) sign (see Figure 2I-1), which may be appended beneath the REST AREA advance guide sign.

Figure 2I-7. Examples of Tourist Information and Welcome Center Signs

Note: Alternate legends may be substituted for the TOURIST INFO CENTER legend, such as WELCOME CENTER and (State Name) WELCOME CENTER.

- 07 The name of the State or local jurisdiction may appear on the Advance Guide and Exit Direction tourist information/welcome center signs if the jurisdiction controls the operation of the tourist information or welcome center and the center meets the operating criteria set forth in this Manual and is consistent with State policies (see Part 2 of ODOT's "Traffic Engineering Manual").

Guidance:

- 08 *For tourist information centers that are located off the freeway or expressway facility, additional signing criteria should be as follows:*
- A. *The tourist information center should be located a maximum of 1 mile from the interchange in order to be included on official signs.*
 - B. *The location of signing should be in accordance with requirements pertaining to General Service signing (see Section 2I.03).*
 - C. *Signing along the crossroad should be installed to guide the road user from the interchange to the tourist information center and back to the interchange.*

Option:

- 09 As an alternative, the Tourist Information (D9-10) sign (see Figure 2I-1) may be appended to the guide signs for the exit that provides access to the tourist information center. As a second alternative, the Tourist Information sign may be combined with General Service signing.

Section 2I.09 Radio Information Signing

Option:

- 01 Radio-Weather Information (D12-1) signs (see Figure 2I-8) may be used in areas where difficult driving conditions commonly result from weather systems. Radio-Traffic Information signs may be used in conjunction with traffic management systems.

Standard:

- 02 **Radio-Weather and Radio-Traffic Information signs shall have a white legend and border on a blue background. Only the numerical indication of the radio frequency shall be used to identify a station broadcasting travel-related weather or traffic information. No more than three frequencies shall be displayed on each sign. Only radio stations whose signal will be of value to the road user and who agree to broadcast either of the following two items shall be identified on Radio-Weather and Radio-Traffic Information signs:**
- A. **Periodic weather warnings at a rate of at least once every 15 minutes during periods of adverse weather; or**
 - B. **Driving condition information (affecting the roadway being traveled) at a rate of at least once every 15 minutes, or when required, during periods of adverse traffic conditions, and when supplied by an official agency having jurisdiction.**
- 03 **If a station to be considered operates only on a seasonal basis, its signs shall be removed or covered during the off season.**

Figure 2I-8. Radio, Telephone, and Carpool Information Signs

D12-1



D12-2



D12-3



D12-4

* The pictograph of the transportation agency or the travel information service or program may be used in place of the 511 pictograph (see Section 2I.10).



D12-5*



D12-5a

Guidance:

- 04 *The radio station should have a signal strength to adequately broadcast 70 miles along the route. Signs should be spaced as needed for each direction of travel at distances determined by an engineering study. The stations to be included on the signs should be selected in cooperation with the association(s) representing major broadcasting stations in the area to provide: (1) maximum coverage to all road users on both AM and FM frequencies; and (2) consideration of 24 hours per day, 7 days per week broadcast capability.*

Option:

- 05 In roadway rest area locations, a smaller sign using a greater number of radio frequencies, but of the same general design, may be used.

Standard:

- 06 **Radio-Weather and Radio-Traffic Information signs installed in rest areas shall be positioned such that they are not visible from the main roadway.**

Option:

- 07 A Channel 9 Monitored (D12-3) sign (see Figure 2I-8) may be installed as needed. Official public agencies or their designees may be displayed as the monitoring agency on the sign.

Standard:

- 08 **Only official public agencies or their designee shall be displayed as the monitoring agency on the Channel 9 Monitored sign.**

Option:

- 09 An EMERGENCY CALL XX (D12-4) sign (see Figure 2I-8) along with the appropriate number to call, may be used for cellular phone communications.

Section 2I.10 TRAVEL INFO CALL 511 Signs (D12-5, D12-5a)

Option:

- 01 A TRAVEL INFO CALL 511 (D12-5) sign (see Figure 2I-8) may be installed if a 511 travel information services telephone number is available to road users for obtaining traffic, public transportation, weather, construction, or road condition information.

- 02 The pictograph of the transportation agency or the travel information service or program that is providing the travel information may be incorporated within the D12-5 sign either above or below the TRAVEL INFO CALL 511 legend.

Standard:

- 03 **The logo of a commercial entity shall not be incorporated within the TRAVEL INFO CALL 511 sign.**

- 04 **The TRAVEL INFO CALL 511 sign shall have a white legend and border on a blue background.**

Guidance:

- 05 *If the pictograph of the transportation agency or the travel information service or program is used, the pictograph's maximum height should not exceed two times the letter height used in the legend of the sign.*

Section 2I.11 Carpool and Ridesharing Signing

Option:

- 01 In areas having carpool matching services, Carpool Information (D12-2) signs (see Figure 2I-8) may be provided adjacent to highways with preferential lanes or along any other highway.

- 02 Carpool Information signs may include an Internet domain name or telephone number of more than four characters within the legend.

Guidance:

- 03 *Because this is an information sign related to road user services, the Carpool Information sign should have a white legend and border on a blue background.*

Standard:

- 04 **If a local transit pictograph or carpool symbol is incorporated into the Carpool Information sign, the maximum vertical dimension of the logo or symbol shall not exceed 18 inches.**

Intentionally blank

CHAPTER 2J. SPECIFIC SERVICE SIGNS

Section 2J.01 State Policy

Support:

- 01 Pursuant to Sections 4511.101 of the Ohio Revised Code (ORC) and 5501:2-6 of the Administrative Code (OAC), the Ohio Department of Transportation (ODOT) has established “a program for placement of business logos for identification purposes on state directional signs within the rights-of-way of divided, multi-lane, limited access highways in both rural and urban area,” including criteria for the availability of the various types of services, sign specifications and program rules. This is commonly referred to as the Logo Program.

Standard:

- 02 **Specific Service signs shall be defined as guide signs that provide road users with business identification and directional information for eligible services and attractions. Eligible service categories shall be limited to gas, food, lodging, camping, and attractions.**

Guidance:

- 03 *The use of Specific Service signs should be limited to areas where adequate sign spacing can be maintained.*

Standard:

- 04 **Specific Service signs shall not be installed at an interchange where the road user cannot conveniently reenter the freeway or expressway and continue in the same direction of travel.**
- 05 **Eligible service facilities shall comply with laws concerning the provisions of public accommodations without regard to race, religion, color, age, sex, or national origin, and laws concerning the licensing and approval of service facilities.**
- 06 **The attraction services shall include only facilities which have the primary purpose of providing amusement, historical, cultural, or leisure activities to the public.**
- 07 **To be eligible, the gas, food, lodging, camping and attraction services shall be located in accordance with the distance criteria established by ODOT (see Paragraph 9).**
- 08 **If local agencies elect to provide Specific Service signing, the ODOT policy for such signing and criteria for the availability of the various types of services, as outlined in this Chapter, shall be used.**

Support:

- 09 Additional information about ODOT’s Logo Program is in Part 2 of the ODOT “Traffic Engineering Manual” (TEM) (see Section 1A.11). Information about the rules and specifications for ODOT’s Logo Program is available by contacting the ODOT Office of Traffic Engineering at the address noted in the front of this Manual.

Section 2J.02 Application

Standard:

- 01 **The number of Specific Service signs along an approach to an interchange or intersection, regardless of the number of service types displayed, shall be limited to a maximum of four. In the direction of traffic, successive Specific Service signs shall be for attraction, camping, lodging, food, and gas services, in that order.**
- 02 **A Specific Service sign shall display the word message GAS, FOOD, LODGING, CAMPING, or ATTRACTION, an appropriate directional legend such as the word message EXIT XX, NEXT RIGHT, SECOND RIGHT, or directional arrows, and the related logo sign panels.**
- 03 **No more than three types of services shall be represented on any sign or sign assembly. If three types of services are displayed on one sign, then the logo sign panels shall be limited to two for each service type (for a total of six logo sign panels). If two types of services are displayed on one sign, then the logo sign panels shall be limited to either three for each service type (for a total of six logo sign panels) or four for one service type and two for the other service type (for a total of six logo sign panels). The legend and logo sign panels applicable to a service type shall be displayed such that the road user will not associate them with another service type on the same sign.**
- 04 **No service type shall appear on more than two signs (see Paragraph 6).**

Figure 2J-1. Examples of Specific Service Signs

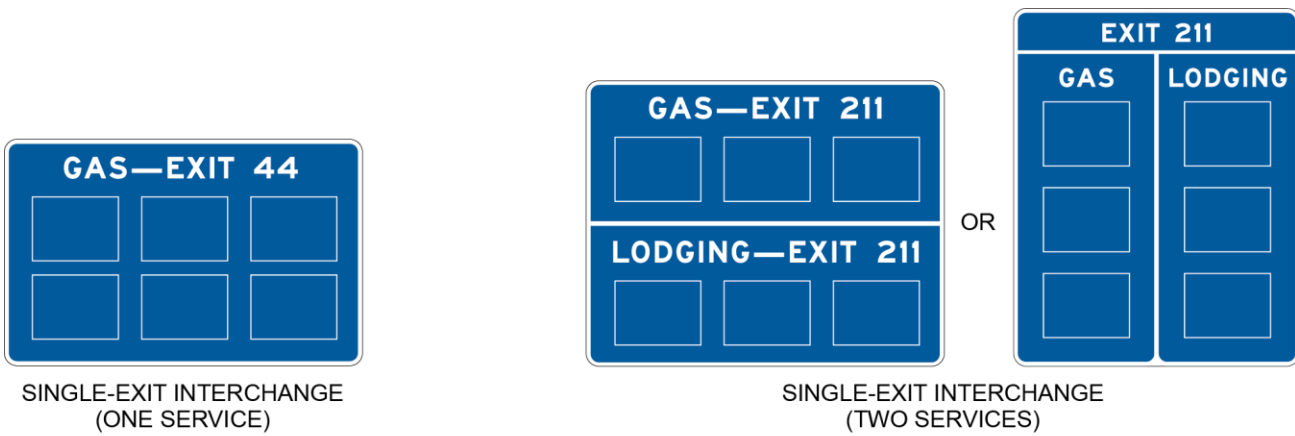

SINGLE-EXIT INTERCHANGE
(ONE SERVICE)

SINGLE-EXIT INTERCHANGE
(TWO SERVICES)

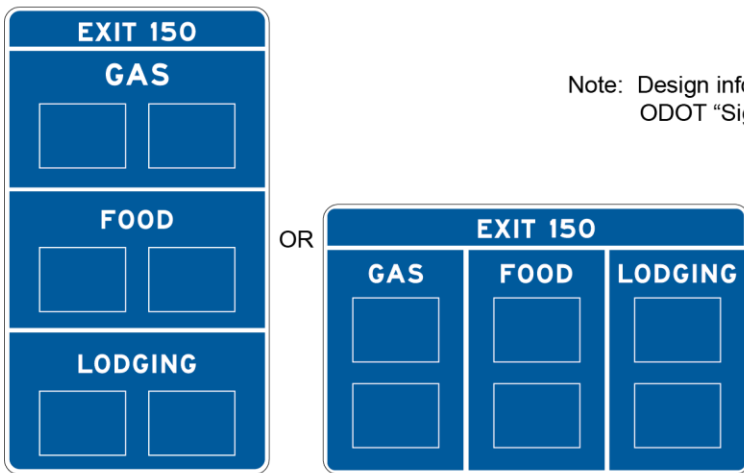

SINGLE-EXIT INTERCHANGE (THREE SERVICES)

Note: Design information for these signs is included in the ODOT "Sign Designs and Markings Manual" (SDMM).



LOGO SIGN PANEL

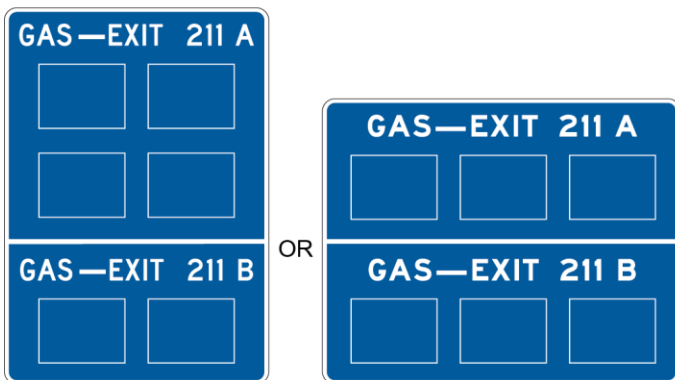

DOUBLE-EXIT INTERCHANGE

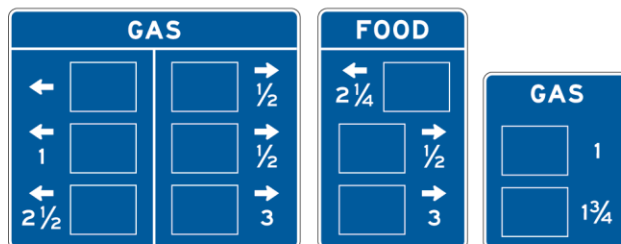

RAMP

Figure 2J-2. Examples of Specific Service Sign Locations

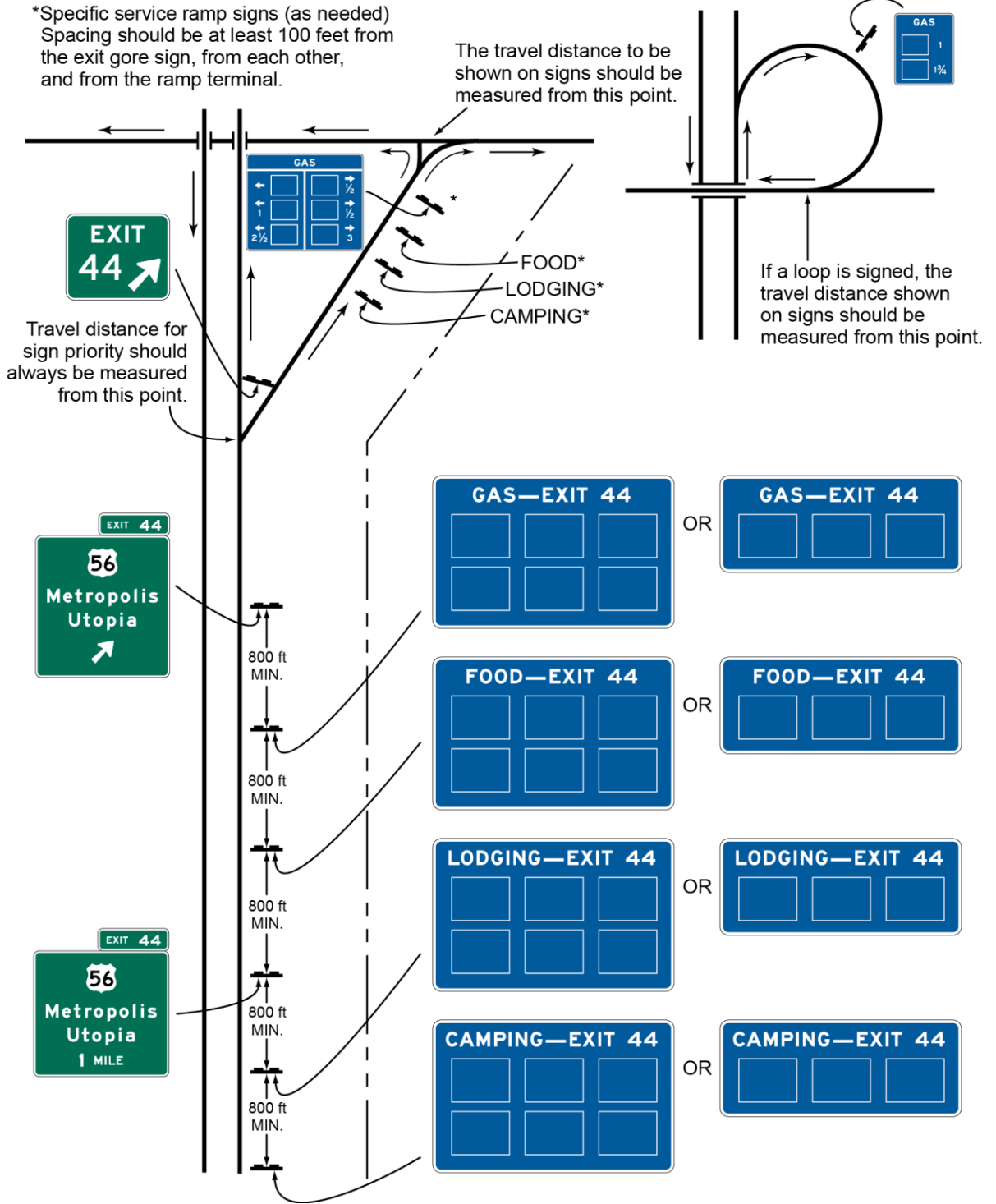

The signs shall have a blue background, a white border, and white legends of upper-case letters, numbers, and arrows.

Guidance:

Where a service type is displayed on two signs, the signs for that service should follow one another in succession.

The Specific Service signs should be located to take advantage of natural terrain, to have the least impact on the scenic environment, and to avoid visual conflict with other signs within the highway right-of-way.

Option:

General Service signs (see Sections 2I.02 and 2I.03) may be used in conjunction with Specific Service signs for eligible types of services that are not represented by a Specific Service sign.

Support:

Examples of Specific Service signs are shown in Figure 2J-1. Examples of sign locations are shown in Figure 2J-2.

Section 2J.03 Logos and Logo Panels

Standard:

A logo shall be either an identification symbol/trademark or a word message. Symbols or trademarks used alone for a logo shall be reproduced in the colors and general shape consistent with customary use, and any integral legend shall be in proportionate size. A logo that resembles an official traffic control device shall not be used.

Each logo shall be placed on a separate logo sign panel that shall be attached to the Specific Service sign. A logo sign panel shall not display the symbol/trademark or name of more than one business.

Guidance:

A word message logo, not using a symbol or trademark, should have a blue background with white legend and border.

Support:

Section 2J.05 contains information regarding the minimum letter heights for logo sign panels.

Option:

Where business identification symbols or trademarks are used alone for a logo, the border may be omitted from the logo sign panel.

A portion of a logo sign panel may be used to display a supplemental message horizontally along the bottom of the logo sign panel, provided that the message displays essential motorist information (see Figure 2J-3).

Standard:

All supplemental messages shall be displayed within the logo sign panel and shall have letters and numerals that comply with the minimum height requirements shown in Table 2J-1.

Guidance:

A logo sign panel should not display more than one supplemental message.

The supplemental message should be displayed in a color to contrast effectively with the background of the business sign or separated from the other legend or logo by a divider bar.

Support:

Typical supplemental messages might include DIESEL, 24 HOURS, CLOSED and the day of the week when the facility is closed, ALTERNATIVE FUELS (see Section 2I.03), and RV ACCESS.

Figure 2J-3. Examples of Supplemental Messages on Logo Sign Panels



- 11 The RV ACCESS supplemental message may be circular.

Standard:

- 12 If the RV ACCESS supplemental message is circular, it shall be the abbreviation RV in black letters inside a yellow circle with a black border and it shall be displayed within the logo sign panel near the lower right-hand corner (see Figure 2J-4).

Guidance:

- 13 If the circular RV ACCESS supplemental message is used, the circle should have a diameter of 10 inches and the letters should have a height of 6 inches.

Option:

- 14 If a business designated as an Interstate Oasis (see Section 2I.04) has a business logo sign panel on the Food and/or Gas Specific Service signs, the word OASIS may be displayed on the bottom portion of the logo sign panel for that business.

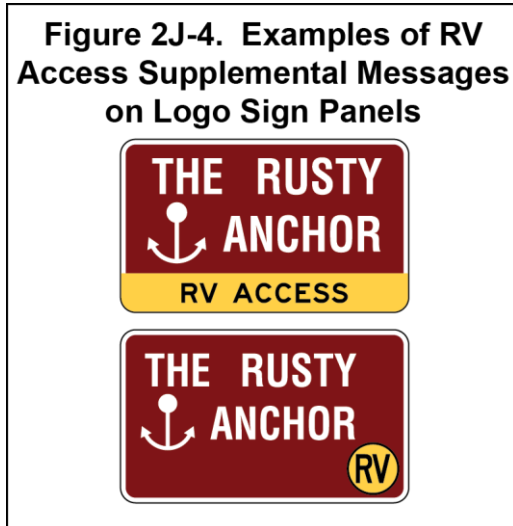

Section 2J.04 Number and Size of Signs and Logo Sign Panels

Guidance:

- 01 Sign sizes should be determined by the amount and height of legend and the number and size of logo sign panels attached to the sign. All logo sign panels on a sign should be the same size.

Standard:

- 02 Each Specific Service sign or sign assembly shall be limited to no more than six logo sign panels.

Option:

- 03 Where more than six businesses of a specific service type are eligible for logo sign panels at the same interchange, additional logo sign panels of that same specific service type may also be displayed in accordance with the provisions of Paragraph 4. The additional logo sign panels may be displayed either by placing more than one specific service type on the same sign (see Paragraph 3 of Section 2J.02) or by using a second Specific Service sign of that specific service type if the additional sign can be added without exceeding the limit of four Specific Service signs on an interchange approach (see Paragraph 6 of Section 2J.02).

Standard:

- 04 Where logo sign panels for more than six businesses of a specific service type are displayed on the same interchange approach, the following provisions shall apply:

- A. No more than 12 logo sign panels of a specific service type shall be displayed on no more than two Specific Service signs or sign assemblies;
- B. No more than six logo sign panels shall be displayed on a single Specific Service sign; and
- C. No more than four Specific Service signs shall be displayed on the approach.

Support:

- 05 Section 2J.08 contains information regarding Specific Service signs for double-exit interchanges.

Standard:

- 06 Each logo sign panel attached to a Specific Service sign shall have a rectangular shape with a width longer than the height. A logo sign panel on signs for freeways and expressways shall not exceed 48 inches in width and 36 inches in height. A logo sign panel on signs for freeway and expressway ramps shall not exceed 24 inches in width and 18 inches in height. The vertical and horizontal spacing between logo sign panels shall not exceed 8 inches and 12 inches, respectively.

Support:

- 07 Sections 2A.14, 2E.15, and 2E.16 contain information regarding borders, interline spacing, and edge spacing.

Table 2J-1. Minimum Letter and Numeral Sizes for Specific Service Signs According to Sign Type

Type of Sign	Freeway or Expressway	Ramp
A. Specific Service Signs		
Service Categories	10	6
Exit Number Words	10	—
Exit Number Numerals and Letters	10	—
Action Message Words	10	—
Distance Numerals	—	6
Distance Fraction Numerals	—	4
B. Logo Sign Panels		
Logo Sign Panels	48 x 36	24 x 18
Words and Numerals (Non-Trademark/Graphic Logo)	8	4
Trademark/Graphic Logo	Proportional	Proportional
Supplemental Message Words and Numerals	5	2.5

Note: Sizes are shown in inches and where applicable are shown as width x height.

Section 2J.05 Size of Lettering

Standard:

- 01 All Specific Service signs and logo sign panels shall have letter and numeral sizes that comply with the minimum requirements of Table 2J-1.

Guidance:

- 02 Any legend on a symbol/trademark should be proportional to the size of the symbol/trademark.

Section 2J.06 Signs at Interchanges

Standard:

- 01 The Specific Service signs shall be installed between the preceding exit and at least 800 feet in advance of the Exit Direction sign at the interchange from which the services are available (see Figure 2J-2).

Guidance:

- 02 There should be at least an 800-foot spacing between the Specific Service signs, except for Specific Service ramp signs. However, excessive spacing is not desirable. Specific Service ramp signs should be spaced at least 100 feet from the Exit Gore sign, from each other, and from the ramp terminal.

Section 2J.07 Single-Exit Interchanges

Standard:

- 01 At numbered single-exit interchanges, the name of the service type followed by the exit number shall be displayed above the logo sign panels. At unnumbered interchanges, the directional legend NEXT RIGHT (LEFT) shall be used.

- 02 At single-exit interchanges, Specific Service ramp signs shall be installed along the ramp or at the ramp terminal for facilities that have logo sign panels displayed along the main roadway if the facilities are not readily visible from the ramp terminal. Directions to the service facilities shall be indicated by arrows on the ramp signs. Logo sign panels on Specific Service ramp signs shall be

duplicates of those displayed on the Specific Service signs located in advance of the interchange, but shall be reduced in size (see Paragraph 6 of Section 2J.04).

- 03 **Specific Service ramp signs shall include distances to the service facilities.**

Section 2J.08 Double-Exit Interchanges

Guidance:

- 01 *At double-exit interchanges, the Specific Service signs should consist of two sections, one for each exit (see Figure 2J-1).*

Standard:

- 02 **At a double-exit interchange, the top section shall display the logo sign panels for the first exit and the bottom section shall display the logo sign panels for the second exit. At numbered interchanges, the name of the service type and the exit number shall be displayed above the logo sign panels in each section. At unnumbered interchanges, the word message NEXT RIGHT (LEFT) and SECOND RIGHT (LEFT) shall be used in place of the exit number. The number of logo sign panels on the sign (total of both sections) or the sign assembly shall be limited to six.**

Guidance:

- 03 *At a double-exit interchange, where a service type is displayed on two Specific Service signs in accordance with the provisions of Section 2J.04, one of the signs should display the logo sign panels for that service type for the businesses that are accessible from one of the two exits and the other sign should display the logo sign panels for that service type for the businesses that are accessible from the other exit.*

Option:

- 04 *At a double-exit interchange where there are four logo sign panels to be displayed for one of the exits and one or two logo sign panels to be displayed for the other exit, the logo sign panels may be arranged in three rows with two logo sign panels per row.*
- 05 *At a double-exit interchange, where a service is to be signed for only one exit, one section of the Specific Service sign may be omitted, or a single exit interchange sign may be used. Signs on ramps and crossroads as described in Section 2J.07 may be used at a double-exit interchange.*

Section 2J.09 Specific Service Trailblazer Signs

Support:

- 01 *Specific Service trailblazer signs (see Figure 2J-5) are guide signs with one to four logo sign panels that display business identification and directional information for services and for eligible attractions. Specific Service trailblazer signs are installed along crossroads for facilities that have logo sign panels displayed along the main roadway and ramp, and that require additional vehicle maneuvers.*

Standard:

- 02 **Specific Service trailblazer signs shall be installed along crossroads where the route to the business requires a direction change, where it is questionable as to which roadway to follow, or where additional guidance is needed. Where it is not feasible or practical to install Specific Service trailblazer signs to such businesses, those businesses shall not be considered eligible for signing from the ramp and main roadway. A Specific Service trailblazer sign shall not be required at the point where the business is visible from the roadway and its access is readily apparent.**

Guidance:

- 03 *If used, a Specific Service trailblazer sign should be located a maximum of 500 feet in advance of any required turn.*

Standard:

- 04 **The location of other traffic control devices shall take precedence over the location of a Specific Service trailblazer sign.**
- 05 **When used, each Specific Service trailblazer sign or sign assembly shall be limited to no more than four logo sign panels. The logo sign panels on Specific Service trailblazer signs shall be duplicates of those displayed on the Specific Service ramp signs.**

06 **Appropriate legends, such as directional arrows or the word message NEXT RIGHT or SECOND**
 07 **RIGHT, shall be displayed with the logo sign panel to provide proper guidance. The directional**
 08 **legend and border shall be white and shall be displayed on a blue background.**

Option:

07 Specific Service trailblazer signs may contain various types of services on a single sign or on a sign
 assembly.

08 Specific Service trailblazer signs may be placed farther from the edge of the road than other traffic
 control signs.

Section 2J.10 Signs at Intersections

Standard:

01 **Except for Specific Service trailblazer signs, Specific Service signs shall not be used at**
 intersections.

Support:

02 See Chapter 2K for information about tourist-oriented directional signs (TODS). These signs are used to
 display the business identification of and directional information to business, service, and activity facilities on
 conventional roads.

Figure 2J-5. Examples of Specific Service Trailblazer Signs

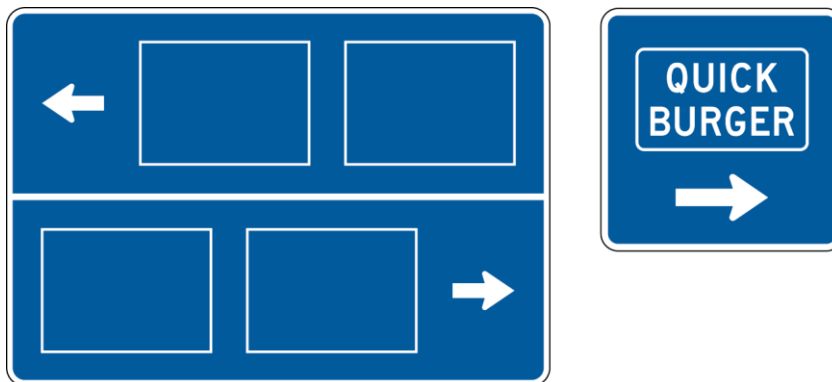

CHAPTER 2K. TOURIST-ORIENTED DIRECTIONAL SIGNS

Section 2K.01 State Policy

Support:

- 01 Tourist-oriented directional signs (TODS) are guide signs with one or more panels that display the business identification of and directional information for business, service, and activity facilities.
- 02 Pursuant to Sections 4511.102 through 4511.105 of the Ohio Revised Code (ORC) and Section 5501:2-8 of the Ohio Administrative Code (OAC), the Ohio Department of Transportation (ODOT) has established and described in this Chapter “a program for the placement of tourist-oriented directional signs and trailblazer markers within the rights-of-way of those portions of rural state highways that are not on the interstate system,” including criteria for availability of the various types of services, sign specifications and program rules. This is commonly referred to as the TODS Program.
- 03 ORC Section 4511.106 requires that any local authority electing to establish a TODS program conform to the rules and specifications contained in the program established by ODOT.
- 04 Copies of the related ORC sections are available in Appendix B2.

Standard:

- 05 **A facility shall be eligible for tourist-oriented directional signs only if it derives its major portion of income or visitors during the normal business season from road users not residing within 10 miles of the facility and attendance at which is no less than 2,000 in any consecutive twelve month period.**
- 06 **Eligible facilities shall comply with applicable State or Federal laws concerning the provisions of public accommodations without regard to race, religion, color, age, sex, or national origin, and laws concerning the licensing and approval of service facilities.**

Option:

- 07 Tourist-oriented directional signs may include businesses involved with seasonal agricultural products.

Standard:

- 08 **When used, tourist-oriented directional signs shall be used only at intersections on rural conventional roads and expressways. They shall not be used at intersections on conventional roads or expressways in urban areas or at interchanges on freeways or expressways. They shall not be used on conventional roads to direct traffic onto a freeway ramp.**

Option:

- 09 Tourist-oriented directional signs may be used in conjunction with General Service signs (see Section 2I.02).

Support:

- 10 Additional information about ODOT’s TODS Program is in Part 2 of the ODOT “Traffic Engineering Manual” (see Section 1A.11).

Section 2K.02 Application

Standard:

- 01 **Tourist-oriented directional signs shall have one or more sign panels for the purpose of displaying the business identification of and directional information for eligible facilities. Each sign panel shall be rectangular in shape and shall have a white legend and border on a blue background.**
- 02 **The content of the legend on each sign panel shall be limited to the identification and directional information for no more than one eligible business, service, or activity facility. The legends shall not include promotional advertising.**

Guidance:

- 03 *Each sign panel should have a maximum of two lines of legend including no more than one symbol, a separate directional arrow, and the distance to the facility displayed beneath the arrow. Arrows pointing to the left or up should be at the extreme left of the sign panel. Arrows pointing to the right should be at the extreme right of the sign panel. Symbols, when used, should be to the left of the word legend or logo sign panel.*

Option:

04 The General Service sign symbols (see Section 2I.02) and the symbols for recreational and cultural interest area signs (see Chapter 2M) may be used.

05 Logo sign panels (see Section 2J.03) for specific businesses, services, and activities may also be used. Based on engineering judgment, the hours of operation may be displayed on the sign panels.

Standard:

06 **When used, symbols and logo sign panels shall be an appropriate size (see Section 2K.04). Logos resembling official traffic control devices shall not be permitted.**

07 **The tourist-oriented directional sign shall display the word message TOURIST ACTIVITIES at the top of the sign.**

08 **The TOURIST ACTIVITIES word message shall have a white legend in all upper-case letters and a white border on a blue background. It shall be placed above and in addition to the directional sign panels.**

Support:

09 Examples of tourist-oriented directional signs are shown in Figures 2K-1 and 2K-2.

Section 2K.03 Style and Size of Lettering*Guidance:*

01 *All letters and numbers on tourist-oriented directional signs, except on the logo sign panels, should be upper-case and at least 6 inches in height. Any legend on a logo should be proportional to the size of the logo.*

Standard:

02 **Design standards for letters, numerals, and spacing shall be as provided in the "Sign Designs and Markings Manual" (SDMM) (see Section 1A.11).**

Section 2K.04 Arrangement and Size of Signs**Standard:**

01 **The size of a tourist-oriented directional sign shall be limited to a maximum height of 6 feet. Additional height shall be allowed to accommodate the addition of the TOURIST ACTIVITIES message provided in Section 2K.02 and the action messages provided in Section 2K.05.**

02 **The number of intersection approach signs (one sign for tourist-oriented destinations to the left, one for destinations to the right, and one for destinations straight ahead) installed at an intersection shall not exceed three. The left and right assemblies shall be located on the approach to the intersection, and the straight-through assembly on the far side of the intersection.**

03 **The number of sign panels installed on each sign shall not exceed four.**

Guidance:

04 *The sign panels for right-turn, left-turn, and straight-through destinations should be on separate signs. The left-turn destination sign should be located farthest from the intersection, then the right-turn destination sign, with the straight-through destination sign located closest to the intersection (see Figure 2K-2).*

Standard:

05 **Signs for facilities in the straight-through direction shall be considered only when there are signs for similar destinations in either the left or right direction.**

Guidance:

06 *If it has been determined to be appropriate to combine the left-turn and right-turn destination sign panels on a single sign, the left-turn destination sign panels should be above the right-turn destination sign panels (see Figure 2K-1). When there are multiple destinations in the same direction, they should be in order based on their distance from the intersection.*

07 *Except as provided in Paragraph 10, a straight-through sign panel should not be combined with a sign displaying left- and/or right-turn destinations.*

Figure 2K-1. Examples of Tourist-Oriented Directional Signs

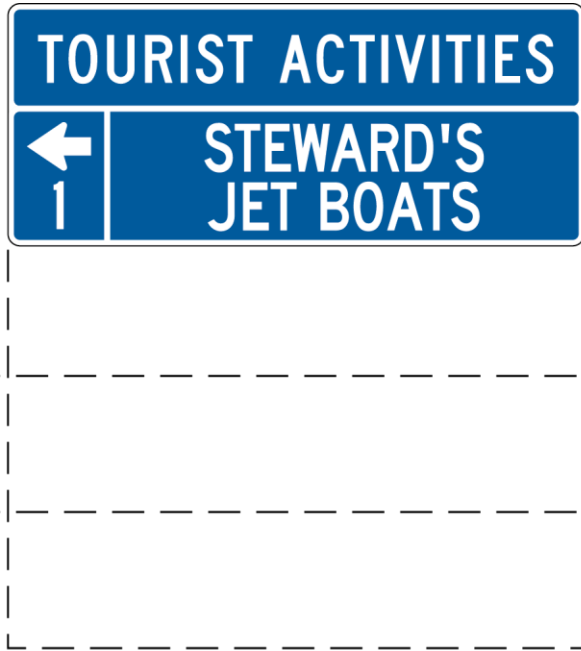

INTERSECTION APPROACH SIGN

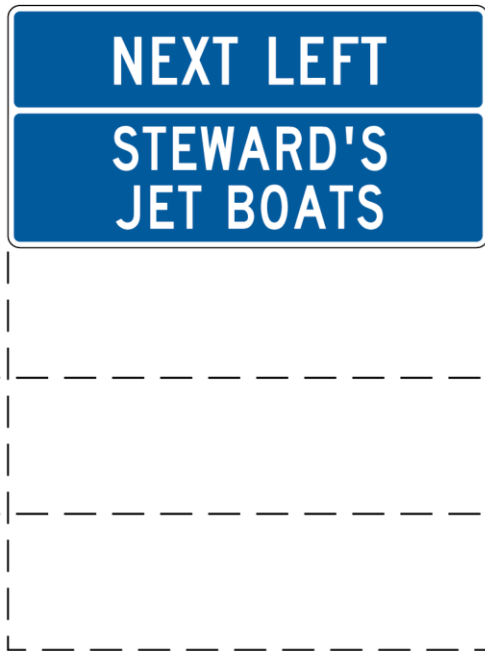

ADVANCE SIGN



COMBINED SIGN

Figure 2K-2. Examples of Intersection Approach Signs and Advance Signs for Tourist-Oriented Directional Signs

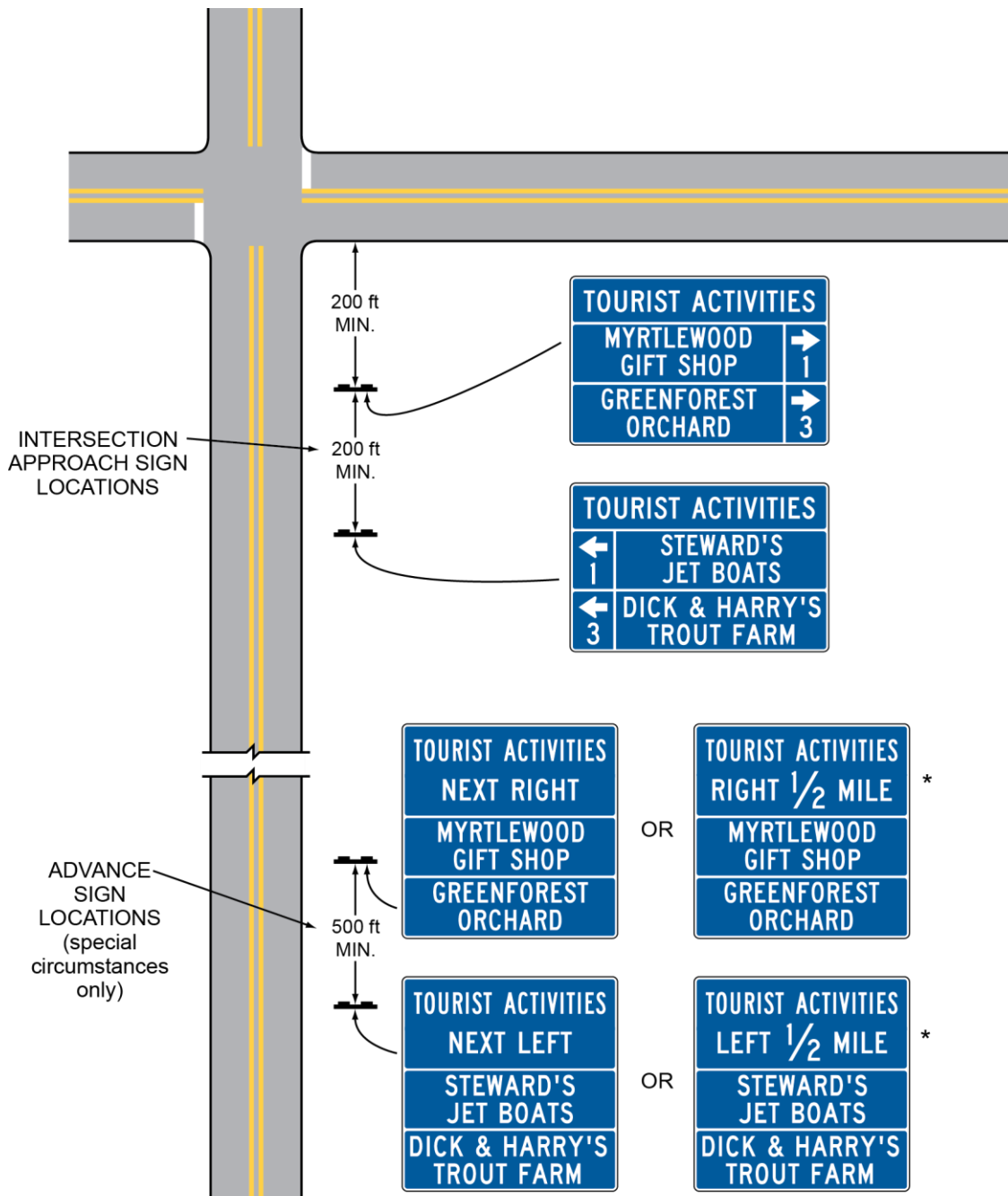

* Use if there is an intervening intersection.

08 *The sign panels should not exceed the size necessary to accommodate two lines of legend without crowding. Symbols and logo sign panels on a directional sign panel should not exceed the height of two lines of a word legend.*

Standard:

09 **All directional sign panels and other parts of the sign shall be the same width, which shall not exceed 6 feet.**

Option:

10 At intersection approaches where three or fewer facilities are displayed, the left-turn, right-turn, and straight-through destination sign panels may be combined on the same sign.

Section 2K.05 Advance Signs

Guidance:

01 *Advance signs should be limited to those situations where sight distance, intersection vehicle maneuvers, or other vehicle operating characteristics require advance notification of the destinations and their directions.*

02 *The design of the advance sign should be identical to the design of the intersection approach sign, except that the directional arrows and distances to the destinations should be omitted and the action messages NEXT RIGHT, NEXT LEFT, or AHEAD should be placed on the sign above the business identification sign panels. The action messages should have the same letter height as the other word messages on the directional sign panels (see Figures 2K-1 and 2K-2).*

Standard:

03 **The action message sign panels shall have a white legend in all upper-case letters and a white border on a blue background.**

Option:

04 The legend RIGHT 1/2 MILE or LEFT 1/2 MILE may be used on advance signs when there are intervening minor roads.

05 The height required to add the directional word messages recommended for the advance sign may be added to the maximum sign height of 6 feet.

Guidance:

06 *The TOURIST ACTIVITIES message, when used on an advance sign, and the action message should be combined on a single sign panel with TOURIST ACTIVITIES as the top line and the action message as the bottom line (see Figure 2K-2).*

Section 2K.06 Sign Locations

Standard:

01 **If used, the intersection approach signs shall be located at least 200 feet in advance of the intersection. Signs shall be spaced at least 200 feet apart and at least 200 feet from other traffic control devices.**

02 **If used, advance signs shall be located approximately 1/2 mile from the intersection with 500 feet between these signs.**

Guidance:

03 *In the direction of travel, the order of advance sign placement should be to show the destinations to the left first, then destinations to the right, and last, the destinations straight ahead.*

04 *Position, height, and lateral offset of signs should be governed by Chapter 2A except as permitted in this Section.*

Option:

05 Tourist-oriented directional signs may be placed further from the edge of the road than other traffic control signs.

Standard:

- 06 **The location of other traffic control devices shall take precedence over the location of tourist-oriented directional signs.**

CHAPTER 2L. CHANGEABLE MESSAGE SIGNS

Section 2L.01 Description of Changeable Message Signs

Support:

- 01 A changeable message sign (CMS) is a traffic control device that is capable of displaying one or more alternative messages. Some changeable message signs have a blank mode when no message is displayed, while others display multiple messages with only one of the messages displayed at a time (such as OPEN/CLOSED signs at weigh stations).
- 02 The provisions in this Chapter apply to both permanent and portable changeable message signs with electronic displays. Additional provisions that only apply to portable changeable message signs can be found in Section 6F.60. The provisions in this Chapter do not apply to changeable message signs with non-electronic displays that are changed either manually or electromechanically, such as a hinged-panel, rotating-drum, or back-lit curtain or scroll CMS.

Standard:

- 03 **Except as provided in Paragraph 2 of Section 2L.02, changeable message signs shall display only traffic operational, regulatory, warning, and guidance information. Advertising messages shall not be displayed on changeable message signs or its supports or other equipment.**
- 04 **The design of legends for non-electronic display changeable message signs shall comply with the provisions of Chapters 2A through 2K, 2M, and 2N of this Manual. All other changeable message signs shall comply with the design and application principles established in this Chapter and in Chapter 2A.**

Guidance:

- 05 *Blank-out signs that display only single-phase, predetermined electronic-display legends that are limited by their composition and arrangement of pixels or other illuminated forms in a fixed arrangement (such as a blank-out sign indicating a part-time turn prohibition, a blank-out or changeable lane-use sign, or a changeable OPEN/CLOSED sign for a weigh station) should comply with the provisions of the applicable Section for the specific type of sign, provided that the letter forms, symbols, and other legend elements are duplicates of the static messages as detailed in the “Sign Designs and Markings Manual” (SDMM) (see Section 1A.11). Because such a sign is effectively an illuminated version of a static sign, the size of its legend elements, the overall size of the sign, and placement of the sign should comply with the applicable provisions for the static version of the sign.*

Section 2L.02 Applications of Changeable Message Signs

Support:

- 01 Changeable message signs have a large number of applications including, but not limited to, the following:
- A. Incident management and route diversion
 - B. Warning of adverse weather conditions
 - C. Special event applications associated with traffic control or conditions
 - D. Control at crossing situations
 - E. Lane, ramp, and roadway control
 - F. Priced or other types of managed lanes
 - G. Travel times
 - H. Warning situations
 - I. Traffic regulations
 - J. Speed control
 - K. Destination guidance

Option:

- 02 Changeable message signs may be used by highway agencies to display safety messages, transportation-related messages, emergency homeland security messages, and America’s Missing: Broadcast Emergency Response (AMBER) alert messages.

Guidance:

- 03 *Highway agencies should develop and establish a policy regarding the display of the types of messages provided in Paragraph 2. When changeable message signs are used at multiple locations to address a specific situation, the message displays should be consistent along the roadway corridor and adjacent corridors, which might necessitate coordination among different operating agencies.*

Support:

- 04 Examples of safety messages include “SEAT BELT BUCKLED?” and “DON’T DRINK AND DRIVE.” Examples of transportation-related messages include “STADIUM EVENT SUNDAY, EXPECT DELAYS NOON TO 4 PM” and “OZONE ALERT CODE RED—USE TRANSIT.”

Guidance:

- 05 *When a CMS is used to display a safety or transportation related message, the message should be simple, brief, legible, and clear. A CMS should not be used to display a safety or transportation-related message if doing so would adversely affect respect for the sign. “CONGESTION AHEAD” or other overly simplistic or vague messages should not be displayed alone. These messages should be supplemented with a message on the location or distance to the congestion or incident delay and travel time, alternative route, or other similar messages.*

Standard:

- 06 **When a CMS is used to display a safety, transportation-related, emergency homeland security, or AMBER alert message, the display format shall not be of a type that could be considered similar to advertising displays.**

Support:

- 07 Section 2B.13 contains information regarding the design of changeable message signs that are used to display the speed at which approaching drivers are traveling.

Section 2L.03 Legibility and Visibility of Changeable Message Signs**Support:**

- 01 The maximum distance at which a driver can first correctly identify letters and words on a sign is called the legibility distance of the sign. Legibility distance is affected by the characteristics of the sign design and the visual capabilities of drivers. Visual capabilities, and thus legibility distances, vary among drivers.

- 02 For the more common types of changeable message signs, the longest measured legibility distances on sunny days occur during mid-day when the sun is overhead. Legibility distances are much shorter when the sun is behind the sign face, when the sun is on the horizon and shining on the sign face, or at night.

- 03 Visibility is the characteristic that enables a CMS to be seen. Visibility is associated with the point where the CMS is first detected, whereas legibility is the point where the message on the CMS can be read. Environmental conditions such as rain, fog, and snow impact the visibility of changeable message signs and can reduce the available legibility distances. During these conditions, there might not be enough viewing time for drivers to read the message.

Guidance:

- 04 *Changeable message signs used on roadways with speed limits of 55 mph or higher should be visible from 1/2 mile under both day and night conditions. The message should be designed to be legible from a minimum distance of 600 feet for nighttime conditions and 800 feet for normal daylight conditions. When environmental conditions that reduce visibility and legibility are present, or when the legibility distances stated in the previous sentences in this paragraph cannot be practically achieved, messages composed of fewer units of information should be used and consideration should be given to limiting the message to a single phase (see Section 2L.05 for information regarding the lengths of messages displayed on changeable message signs).*

Section 2L.04 Design Characteristics of Changeable Message Signs**Standard:**

- 01 **Changeable message signs shall not include advertising, animation, rapid flashing, dissolving, exploding, scrolling, or other dynamic elements.**

- 02 Section 6F.61 contains information regarding the use of arrow boards that use flashing or sequential displays for lane closures.

Guidance:

- 03 *Except in the case of a limited-legend CMS (such as a blank-out or electronic-display changeable message regulatory sign) that is used in place of a static regulatory sign or an activated blank-out warning sign that supplements a static warning sign at a separate location, changeable message signs should be used as a supplement to and not as a substitute for conventional signs and markings.*

- 04 *CMS should be limited to no more than three lines, with no more than 20 characters per line.*

- 05 *The spacing between characters in a word should be between 25 to 40 percent of the letter height. The spacing between words in a message should be between 75 and 100 percent of the letter height. Spacing between the message lines should be between 50 and 75 percent of the letter height.*

- 06 *Except as provided in Paragraph 18, word messages on changeable message signs should be composed of all upper-case letters. The minimum letter height should be 18 inches for changeable message signs on roadways with speed limits of 45 mph or higher. The minimum letter height should be 12 inches for changeable message signs on roadways with speed limits of less than 45 mph.*

Support:

- 07 Using letter heights of more than 18 inches will not result in proportional increases in legibility distance.

Guidance:

- 08 *The width-to-height ratio of the sign characters should be between 0.7 and 1.0. The stroke width-to-height ratio should be 0.2.*

Support:

- 09 The width-to-height ratio is commonly accomplished using a minimum font matrix density of five pixels wide by seven pixels high.

Standard:

- 10 **Changeable message signs shall automatically adjust their brightness under varying light conditions to maintain legibility.**

Guidance:

- 11 *The luminance of changeable message signs should meet industry criteria for daytime and nighttime conditions. Luminance contrast (see Section 1A.13) should be between 8 and 12 for all conditions.*

- 12 *Contrast orientation of changeable message signs should always be positive, that is, with luminous characters on a dark or less luminous background.*

Support:

- 13 Legibility distances for negative-contrast changeable message signs are likely to be at least 25 percent shorter than those of positive-contrast messages. In addition, the increased light emitted by negative-contrast changeable message signs has not been shown to improve detection distances.

Standard:

- 14 **The colors used for the legends and backgrounds on changeable message signs shall be as provided in Table 2A-5.**

Guidance:

- 15 *If a black background is used, the color used for the legend on a changeable message sign should match the background color that would be used on a standard sign for that type of legend, such as white for regulatory, yellow for warning, orange for temporary traffic control, red for stop or yield, fluorescent pink for incident management, and fluorescent yellow-green for bicycle, pedestrian, and school warning.*

Standard:

- 16 **If a green background is used for a guide message on a CMS or if a blue background is used for a motorist services message on a CMS, the background color shall be provided by green or blue lighted pixels such that the entire CMS would be lighted, not just the white legend.**

17 Some CMS that employ newer technologies have the capability to display an exact duplicate of a standard sign or other sign legend using standard symbols, the Standard Alphabets and letter forms, route shields, and other typical sign legend elements with no apparent loss of resolution or recognition to the road user when compared with a static version of the same sign legend. Such signs are of the full-matrix type and can typically display full-color legends. Use of such technologies for new CMS is encouraged for greater legibility of their displays and enhanced recognition of the message as it pertains to regulatory, warning, or guidance information.

Guidance:

18 *If used, the CMS described in the preceding paragraph should not display symbols or route shields unless they can do so in the appropriate color combinations. For a single-phase message where the Standard Alphabets and other legend elements of standard designs are used, the lettering style, size, and line spacing should comply with the applicable provisions for the type of message displayed as provided elsewhere in this Manual. For two-phase messages, larger legend heights should be used as described previously in this Section because of the need for such messages to be legible at a greater distance. Regardless of the number of phases, the CMS should comply with the legibility and visibility provisions of Section 2L.03.*

Section 2L.05 Message Length and Units of Information

Guidance:

01 *The maximum length of a message should be dictated by the number of units of information contained in the message, in addition to the size of the CMS. A unit of information, which is a single answer to a single question that a driver can use to make a decision, should not be more than four words.*

Support:

02 In order to illustrate the concept of units of information, Table 2L-1 shows an example message that is comprised of four units of information.

03 The maximum allowable number of units of information in a CMS message is based on the principles described in this Section, the current highway operating speed, the legibility characteristics of the CMS, and the lighting conditions.

Standard:

04 **Each message shall consist of no more than two phases. A phase shall consist of no more than three lines of text. Each phase shall be understood by itself regardless of the sequence in which it is read. Messages shall be centered within each line of legend. Except for signs located on toll plaza structures or other facilities with a similar booth-lane arrangement, if more than one CMS is visible to road users, then only one sign shall display a sequential message at any given time.**

05 **Techniques of message display such as fading, rapid flashing, exploding, dissolving, or moving messages shall not be used. The text of the message shall not scroll or travel horizontally or vertically across the face of the sign.**

Guidance:

06 *When designing and displaying messages on changeable message signs, the following principles relative to message design should be used:*

- A. *The minimum time that an individual phase is displayed should be based on 1 second per word or 2 seconds per unit of information, whichever produces a lesser value. The display time for a phase should never be less than 2 seconds.*
- B. *The maximum cycle time of a two-phase message should be 8 seconds.*
- C. *The duration between the display of two phases should not exceed 0.3 seconds.*
- D. *No more than three units of information should be displayed on a phase of a message.*
- E. *No more than four units of information should be in a message when the traffic operating speeds are 35 mph or more.*
- F. *No more than five units of information should be in a message when the traffic operating speeds are less than 35 mph.*
- G. *Only one unit of information should appear on each line of the CMS.*

Table 2L-1. Example of Units of Information

Question	Answer	Number of Information Units
What happened?	MAJOR CRASH	1
Where?	AT EXIT 12	1
Who is the advisory for?	Drivers Heading TO NEW YORK	1
What is advised?	USE ROUTE 46	1

Note: The following is an example of a two-phase message that could be developed from the four information units shown in this table:

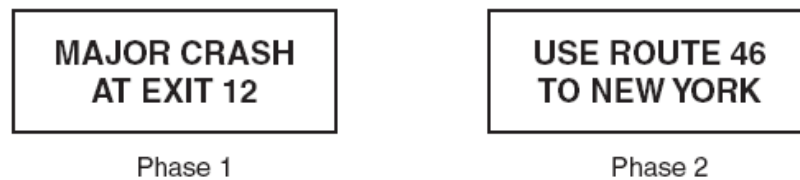

H. Compatible units of information should be displayed on the same message phase.

Option:

- 07 A unit of information consisting of more than one word may be displayed on more than one line. An additional changeable message sign at a downstream location may be used for the purpose of allowing the entire message to be read twice.

Guidance:

- 08 *If more than two phases would be needed to display the necessary information, additional changeable message signs should be used to display this information as a series of two distinct, independent messages with a maximum of two phases at each location, in accordance with the provisions of Paragraph 4.*
- 09 *When the message on a CMS includes an abbreviation, the provisions of Section 1A.15 should be used.*

Section 2L.06 Installation of Permanent Changeable Message Signs

Guidance:

- 01 A CMS that is used in place of a static sign (such as a blank-out or variable legend regulatory sign) should be located in accordance with the provisions of Chapter 2A. The following factors should be considered when installing other permanent changeable message signs:
- A. *Changeable message signs should be located sufficiently upstream of known bottlenecks and high crash locations to enable road users to select an alternate route or take other appropriate action in response to a recurring condition.*
 - B. *Changeable message signs should be located sufficiently upstream of major diversion decision points, such as interchanges, to provide adequate distance over which road users can change lanes to reach one destination or the other.*
 - C. *Changeable message signs should not be located within an interchange except for toll plazas or managed lanes.*
 - D. *Changeable message signs should not be positioned at locations where the information load on drivers is already high because of guide signs and other types of information.*
 - E. *Changeable message signs should not be located in areas where drivers frequently perform lane-changing maneuvers in response to static guide sign information, or because of merging or weaving conditions.*

Support:

- 02 Information regarding the design and application of portable changeable message signs in temporary traffic control zones is contained in Section 6F.60.

Intentionally blank

CHAPTER 2M. RECREATIONAL AND CULTURAL INTEREST AREA SIGNS

Section 2M.01 Scope

Support:

- 01 Recreational or cultural interest areas are attractions or traffic generators that are open to the general public for the purpose of play, amusement, or relaxation. Recreational attractions include such facilities as parks, campgrounds, gaming facilities, and ski areas, while examples of cultural attractions include museums, art galleries, and historical buildings or sites.
- 02 The purpose of recreation and cultural interest area signs is to guide road users to a general area and then to specific facilities or activities within the area.

Option:

- 03 Recreational and cultural interest area guide signs directing road users to significant traffic generators may be used on freeways and expressways where there is direct access to these areas as provided in Section 2M.09.
- 04 Recreational and cultural interest area signs may be used off the road network, as appropriate.

Section 2M.02 Application of Recreational and Cultural Interest Area Signs

Support:

- 01 Provisions for signing recreational or cultural interest areas are subdivided into two different types of signs: (1) symbol signs and (2) destination guide signs.

Guidance:

- 02 *When highway agencies decide to provide recreational and cultural interest area signing, these agencies should have a policy for such signing. The policy should establish signing criteria for the eligibility of the various types of services, accommodations, and facilities. These signs should not be used where they might be confused with other traffic control signs.*

Option:

- 03 Recreational and cultural interest area guide signs may be used on any road to direct persons to facilities, structures, and places, and to identify various services available to the general public. These signs may also be used in recreational or cultural interest areas for signing non-vehicular events and amenities such as trails, structures, and facilities.

Support:

- 04 Section 2A.12 contains information regarding the use of recreational and cultural interest area symbols on other types of signs. The traffic generator policy established by the Ohio Department of Transportation (ODOT) is available in Part 2 of ODOT's "Traffic Engineering Manual" (see Section 1A.11).

Section 2M.03 Regulatory and Warning Signs

Standard:

- 01 **All regulatory and warning signs installed on public roads and streets within recreational and cultural interest areas shall comply with the requirements of Chapters 2A, 2B, 2C, 7B, 8B, and 9B.**

Section 2M.04 General Design Requirements for Recreational and Cultural Interest Area Symbol Signs

Standard:

- 01 **Recreational and cultural interest area symbol guide signs shall be square or rectangular in shape and shall have a white symbol or message and white border on a brown background. The symbols shall be grouped into the following usage categories:**

- A. General Applications,**
- B. Accommodations,**
- C. Services,**
- D. Land Recreation,**
- E. Water Recreation, and**
- F. Winter Recreation.**

Table 2M-1. Category Chart for Recreational and Cultural Interest Area Symbols

General	
Bear Viewing Area	RS-012
Bus Stop	RS-031
Campfires *	RS-042
Cans or Bottles *	RS-101
Cultural Interest Area	RS-142
Dam	RS-009
Deer Viewing Area	RS-011
Falling Rocks *	RS-008
Fire Extinguisher *	RS-090
Lighthouse	RS-007
Lookout Tower	RS-006
Nature Study Area	RS-141
Pets on Leash *	RS-017
Pick-Up Trucks	RS-140
Point of Interest	RS-080
Radios *	RS-103
Rattlesnakes *	RS-099
Recycling *	RS-200
Sea Plane	RS-115
Smoking *	RS-002
Snack Bar *	RS-102
Stay on Trail *	RS-123
Strollers *	RS-111
Tunnel	RS-005
Viewing Area	RS-036
Walk on Boardwalk *	RS-122
Wood Gathering *	RS-120

Accommodations	
Baby Changing Station (Men's Room)	RS-137
Baby Changing Station (Women's Room)	RS-138
Men's Restroom	RS-021
Parking	RS-034
Recreational Vehicle Site	RS-104
Restrooms	RS-022
Sleeping Shelter *	RS-037
Trailer Site	RS-040
Walk-In Camp	RS-148
Women's Restroom	RS-023

Services	
Drinking Water	RS-013
Electrical Hook-Up	RS-150
Firewood Cutting *	RS-112
First Aid	RS-024
Grocery Store	RS-020
Kennel	RS-045
Laundromat	RS-085
Litter Receptacle	RS-086
Lockers/Storage *	RS-030
Mechanic	RS-027
Picnic Shelter	RS-039
Picnic Site	RS-044
Post Office	RS-026
Radiator Water	RS-124
Ranger Station	RS-015
Sanitary Station	RS-041
Showers *	RS-035
Stable	RS-073
Theater	RS-109
Trail Shelter *	RS-043
Tramway	RS-071
Trash Dumpster	RS-091

Land Recreation	
All-Terrain Trail	RS-095
Amphitheater	RS-070
Archery	RS-116
Baseball *	RS-096
Climbing *	RS-082
Corral	RS-149
Driving Tour	RS-113
Exercise/Fitness	RS-097
Golfing *	RS-128
Hang Gliding	RS-126
Hiking Trail	RS-068
Horse Trail	RS-064
In-Line Skating	RS-125
Interpretive Trail	RS-114
Off-Road Vehicle Trail	RS-067
Rock Collecting *	RS-083
Skateboarding *	RS-098
Spelunking/Caves	RS-084
Technical Rock Climbing	RS-081
Tennis	RS-129
Wildlife Viewing	RS-076

Water Recreation	
Beach	RS-145
Boat Motor	RS-147
Boat Ramp	RS-054
Canoeing	RS-079
Diving	RS-062
Fish Cleaning *	RS-093
Fish Hatchery	RS-010
Fish Ladder *	RS-089
Fishing Area	RS-063
Fishing Pier	RS-119
Hand Launch/Small Boat Launch	RS-117
Jet Ski/Personal Watercraft	RS-121
Kayaking	RS-118
Lifejackets *	RS-094
Marina	RS-053
Motorboating	RS-055
Rafting	RS-146
Rowboating	RS-057
Sailing	RS-056
Scuba Diving	RS-060
Seal Viewing	RS-106
Surfing	RS-059
Swimming	RS-061
Tour Boat	RS-087
Wading	RS-088
Waterskiing	RS-058
Whale Viewing	RS-107
Wind Surfing	RS-108

Winter Recreation	
Chair Lift/Ski Lift	RS-105
Cross Country Skiing	RS-046
Dog Sledding	RS-143
Downhill Skiing	RS-047
Ice Fishing	RS-092
Ice Skating	RS-050
Ski Jumping	RS-048
Sledding	RS-049
Snow Tubing	RS-144
Snowboarding	RS-127
Snowmobiling	RS-052
Snowshoeing	RS-078
Winter Rec. Area	RS-077

* For non-road use only

- 02 Table 2M-1 contains a listing of the symbols within each usage category. Drawings showing the design details for these symbols are found in the “Sign Designs and Markings Manual” (SDMM) (see Section 1A.11).
Option:

- 03 Mirror images of symbols may be used where the reverse image will better convey the message. Other symbols shown in Chapter 2I may also be used.

Section 2M.05 Symbol Sign Sizes

Guidance:

- 01 *Recreational and cultural interest area symbol signs should be 24 x 24 inches. Where greater visibility or emphasis is needed, larger sizes should be used. Symbol sign enlargements should be in 6-inch increments.*
- 02 *Recreational and cultural interest area symbol signs should be 30 x 30 inches when used on guide signs on freeways or expressways.*

Option:

- 03 A smaller size of 18 x 18 inches may be used on low-speed, low-volume roadways and on non-road applications.

Section 2M.06 Use of Educational Plaques

Guidance:

- 01 *Educational plaques should accompany all initial installations of recreational and cultural interest area symbol signs. The educational plaque should remain in place for at least 3 years after the initial installation. If used, the educational plaque should be the same width as the symbol sign.*

Option:

- 02 Symbol signs that are readily recognizable by the public may be installed without educational plaques.

Support:

- 03 Figure 2M-1 illustrates some examples of the use of educational plaques.

Section 2M.07 Use of Prohibitive Circle and Diagonal Slash for Non-Road Applications

Standard:

- 01 **Where it is necessary to indicate a prohibition of an activity or an item within a recreational or cultural interest area for non-road use and a standard regulatory sign for such a prohibition is not provided in Chapter 2B, the appropriate recreational and cultural interest area symbol shall be used in combination with a red prohibitive circle and red diagonal slash. The recreational and cultural interest area symbol and the sign border shall be black and the sign background shall be white. The symbol shall be scaled proportionally to fit completely within the circle and the diagonal slash shall be oriented from the upper left to the lower right portions of the circle as shown in Figure 2M-1.**
- 02 **Requirements for retroreflection of the red circle and red diagonal slash shall be the same as those requirements for backgrounds, legends, symbols, arrows, and borders.**

Section 2M.08 Placement of Recreational and Cultural Interest Area Symbol Signs

Standard:

- 01 **If used, recreational and cultural interest area symbol signs shall be placed in accordance with the general requirements contained in Chapter 2A. The symbol(s) shall be placed as sign panels in the uppermost part of the sign and the directional information shall be placed below the symbol(s).**
- 02 **Except as provided in Paragraph 3, if the name of the recreational or cultural interest area facility or activity is displayed on a destination guide sign (see Section 2M.09) and a symbol is used, the symbol shall be placed below the name (see Figure 2M-2).**

Figure 2M-1. Examples of Use of Arrows, Educational Plaques, and Prohibitive Slashes

A - DIRECTIONAL SIGNS



B - DIRECTIONAL ASSEMBLIES

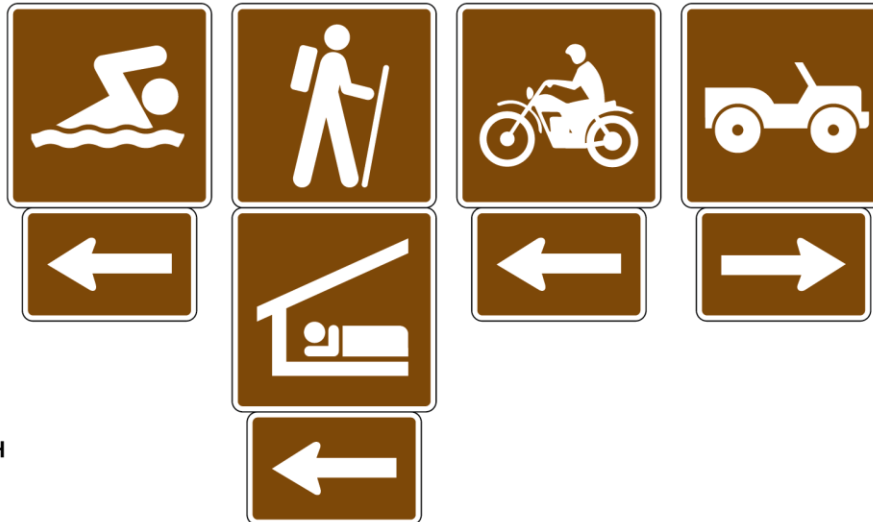

C - DIRECTIONAL ASSEMBLY WITH EDUCATIONAL PLAQUE



D - PROHIBITED ACTIVITIES AND EDUCATIONAL PLAQUE FOR NON-ROAD USE*



* Standard regulatory signs shall be used where provided elsewhere in this Manual.

Option:

- 03 When the legend Wildlife Viewing Area is displayed with the RS-076 symbol on a destination guide sign, the symbol may be placed to the left or right of the legend and the arrow may be placed below the symbol (see Figure 2M-2).
- 04 The symbols displayed with the facility or activity name may be placed below the destination guide sign as illustrated in Figure 2M-2 instead of as sign panels placed with the destination guide sign.
- 05 Secondary symbols of a smaller size (18 x 18 inches) may be placed beneath the primary symbols (see Drawing A in Figure 2M-1), where needed.

Standard:

- 06 **Recreational and cultural interest area symbols installed for non-road use shall be placed in accordance with the general sign position requirements of the authority having jurisdiction.**

Support:

- 07 Figure 2M-3 illustrates typical height and lateral mounting positions. Figure 2M-4 illustrates some examples of the placement of symbol signs within a recreational or cultural interest area. Figure 2M-5 through 2M-10 illustrate some of the symbols that can be used.

Guidance:

- 08 *The number of symbols used in a single sign assembly should not exceed four.*

Option:

- 09 The Advance Turn (M5 series) or Directional Arrow (M6 series) auxiliary signs with white arrows on brown backgrounds shown in Figure 2D-5 may be used with Recreational and Cultural Area Interest symbol

Figure 2M-2. Examples of General Directional Guide Signs for Conventional Roads

A - CONVENTIONAL ROADS

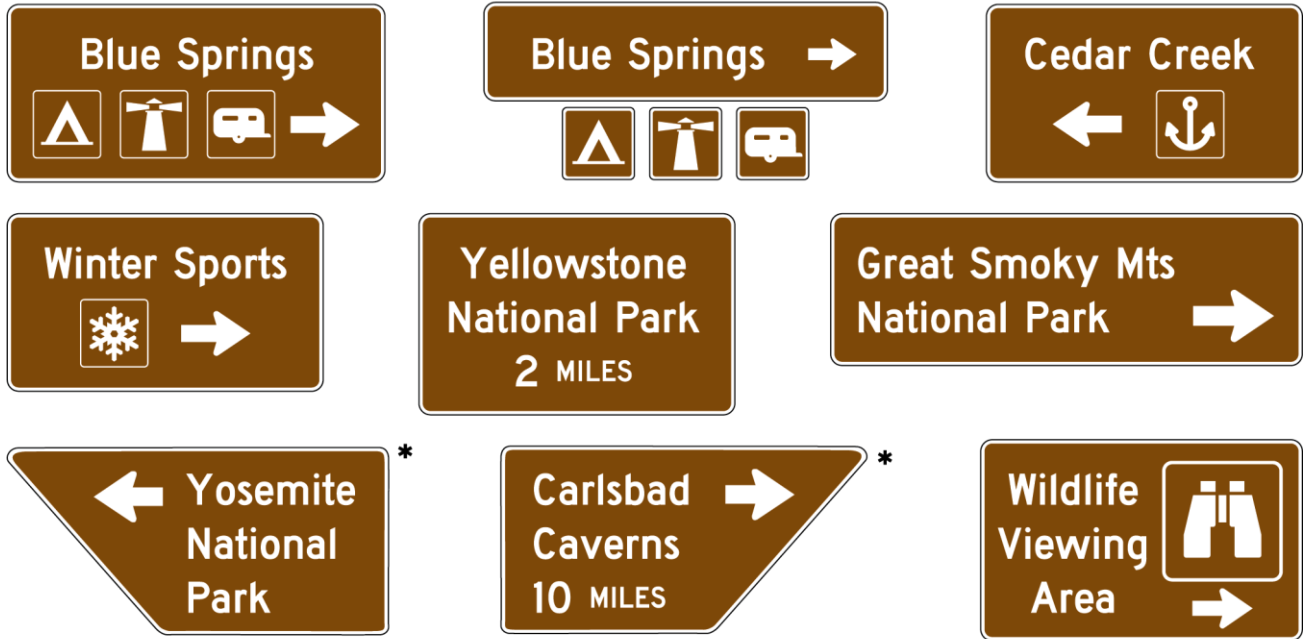

* Optional shape



D7-H1



D7-H1a

B - EXPRESSWAYS AND FREEWAYS

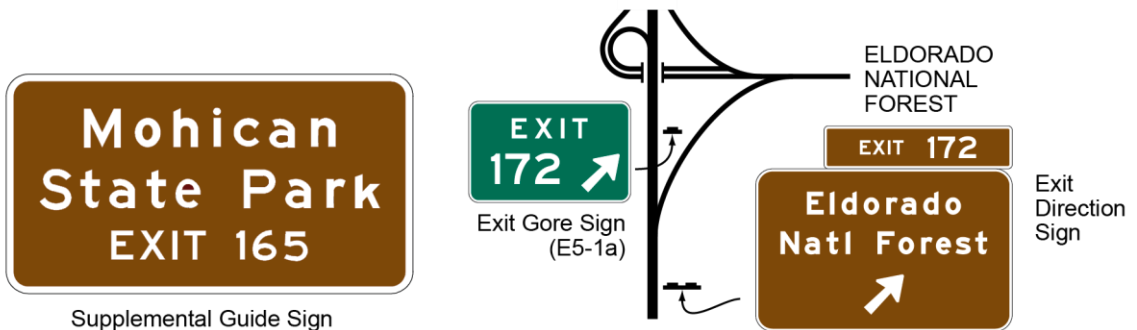

Supplemental Guide Sign

Exit Direction Sign

Figure 2M-3. Arrangement, Height, and Lateral Position of Signs Located Within Recreational and Cultural Interest Areas

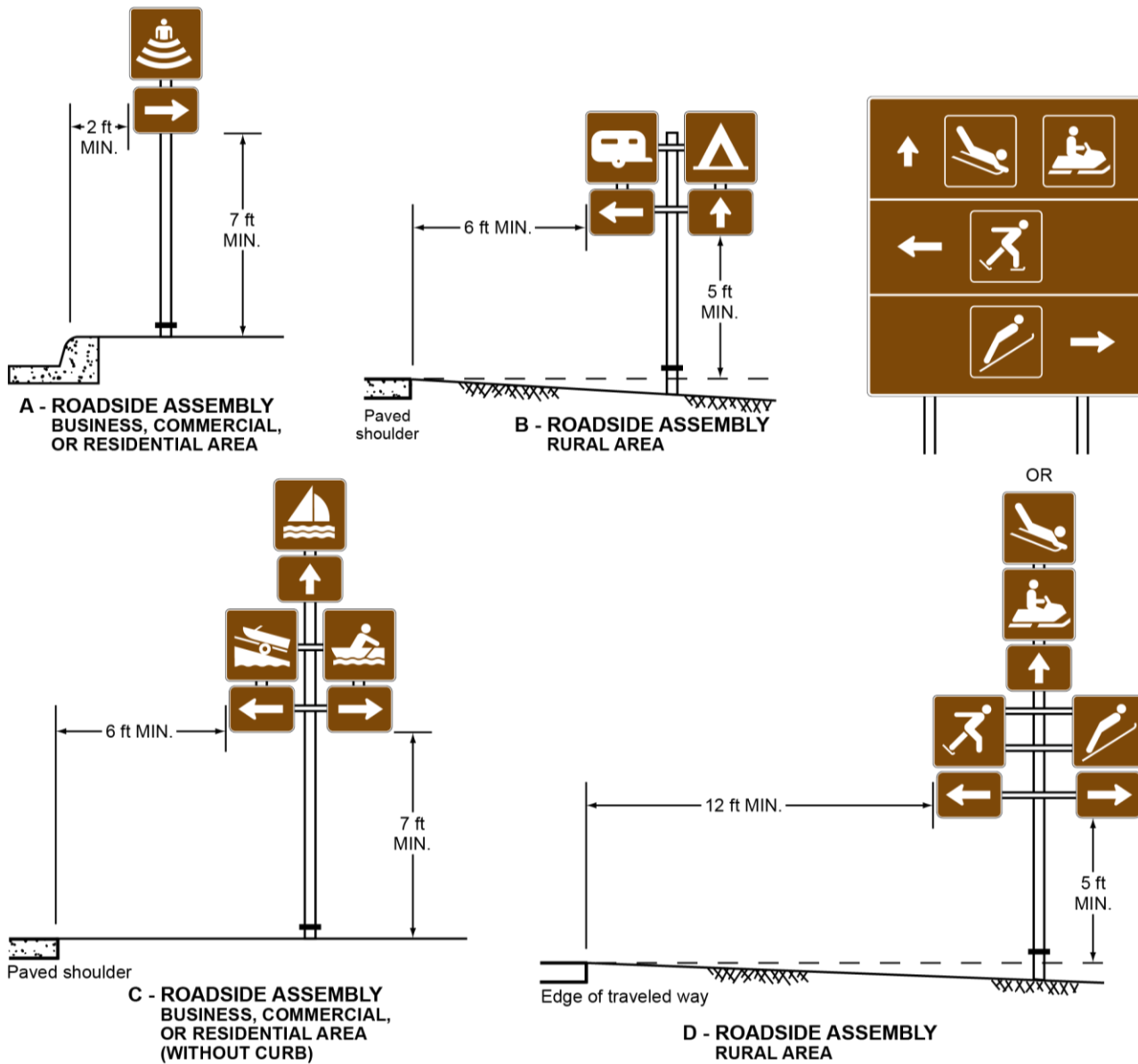

Note: See Section 2A.19 for reduced lateral offset distances that may be used in areas where lateral offsets are limited, and in urban areas where sidewalk width is limited or where existing poles are close to the curb.

guide signs to create a Recreational and Cultural Interest Area Directional Assembly. The symbols may be used singularly, or in groups of two, three, or four on a single sign assembly (see Figures 2M-1, 2M-3, and 2M-4).

Section 2M.09 Destination Guide Signs

Guidance:

- 01 *When recreational or cultural interest area destinations are displayed on supplemental guide signs, the sign should be rectangular or trapezoidal in shape. The order of preference for use of shapes and colors should be as follows: (1) rectangular with a white legend and border on a brown background; (2) rectangular with a white legend and border on a green background; or (3) trapezoidal with a white legend and border on a brown background.*

Figure 2M-5. Recreational and Cultural Interest Area Symbol Signs for General Applications



Figure 2M-6. Recreational and Cultural Interest Area Symbol Signs for Accommodations

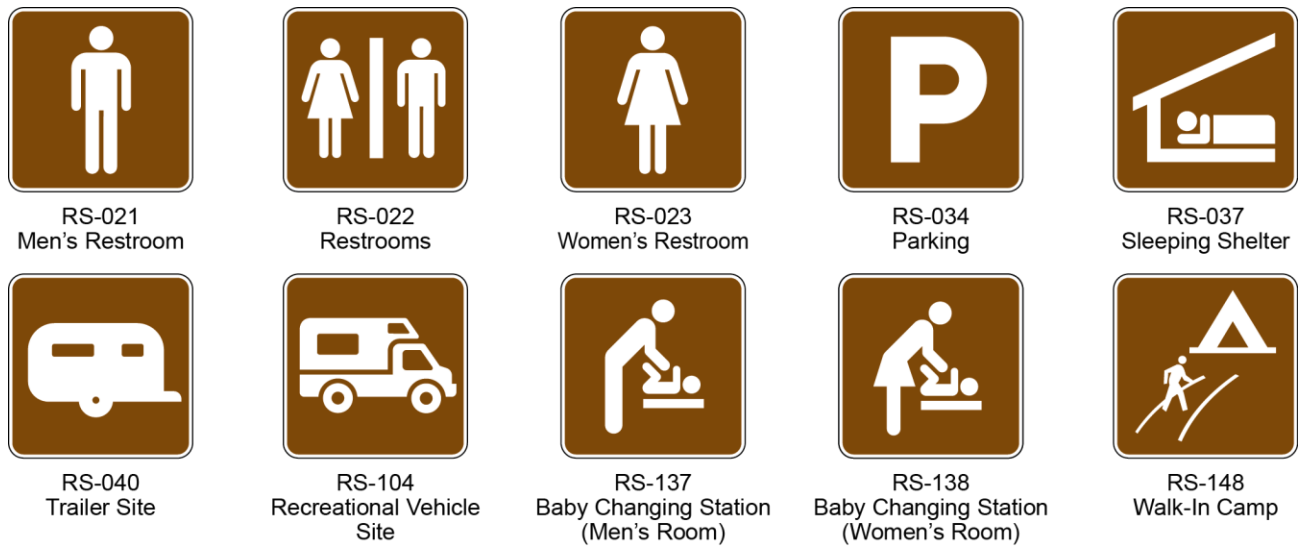

Figure 2M-7. Recreational and Cultural Interest Area Symbol Signs for Services



Figure 2M-8. Recreational and Cultural Interest Area Symbol Signs for Land Recreation



freeways to direct road users to recreational or cultural interest areas. Where access or crossroads lead exclusively to the recreational or cultural interest area, the advance guide sign and the exit direction sign may have a white legend and border on a brown background.

Standard:

04 All Exit Gore (E5-1 and E5-1a) signs (see Section 2E.37) shall have a white legend and border on a green background. The background color of the interchange Exit Number (E1-5P and E1-5bP) plaque (see Section 2E.31) shall match the background color of the guide sign. Design characteristics of conventional road, expressway, or freeway guide signs shall comply with Chapter 2D or 2E except as provided in this Section for color combination.

05 The advance guide sign and the Exit Direction sign shall retain the white-on-green color combination where the crossroad leads to a destination other than a recreational or cultural interest area.

Support:

06 Figure 2M-2 illustrates destination guide signs commonly used for identifying recreational or cultural interest areas or facilities.

Figure 2M-9. Recreational and Cultural Interest Area Symbol Signs for Water Recreation



Figure 2M-10. Recreational and Cultural Interest Area Symbol Signs for Winter Recreation



Guidance:

- 07 *White-on-brown supplemental guide signs should be designed in accordance with the Freeway and Expressway Guide Sign Design Method described in Appendix C of the SDMM (see Section 1A.11).*

Section 2M.10 Memorial or Dedication Signing

Support:

- 01 Legislative bodies will occasionally adopt an act or resolution memorializing or dedicating a highway, bridge, or other component of the highway. A highway designated as a memorial or dedication is not considered to be a named highway.

- 02 Named highways are officially designated and shown on official maps and serve the purpose of providing route guidance, primarily on unnumbered highways. Section 2D.53 contains provisions for the signing of named highways.

Guidance:

- 03 *Such memorial or dedication names should not appear on or along a highway, or be placed on bridges or other highway components. If a route, bridge, or highway component is officially designated as a memorial or dedication, and if notification of the memorial or dedication is to be made on the highway right-of-way, such notification should consist of installing a memorial or dedication marker in a rest area, scenic overlook, recreational area, or other appropriate location where parking is provided with the signing inconspicuously located relative to vehicle operations along the highway.*

Option:

- 04 If the installation of a memorial or dedication marker off the main roadway is not practical, memorial or dedication signs may be installed on the mainline.

Guidance:

- 05 *Memorial or dedication signs should have a white legend and border on a brown background.*

Standard:

- 06 **Where such memorial or dedication signs are installed on the mainline, (1) memorial or dedication names shall not appear on directional guide signs, (2) memorial or dedication signs shall not interfere with the placement of any other necessary signing, and (3) memorial or dedication signs shall not compromise the safety or efficiency of traffic flow. The memorial or dedication signing shall be limited to one sign at an appropriate location in each route direction, each as an independent sign installation.**
- 07 **Memorial or dedication signs shall be rectangular in shape. The legend displayed on memorial or dedication signs shall be limited to the name of the person or entity being recognized and a simple message preceding or following the name, such as “DEDICATED TO” or “Memorial Parkway.” Additional legend, such as biographical information, shall not be displayed on memorial or dedication signs. Decorative or graphical elements, pictographs, logos, or symbols shall not be displayed on memorial or dedication signs. All letters and numerals displayed on memorial or dedication signs shall be as provided in the SDMM (see Section 1A.11). The route number or officially mapped name of the highway shall not be displayed on the memorial or dedication sign.**
- 08 **Memorial or dedication names shall not appear on supplemental signs or on any other information sign on or along the highway or its intersecting routes.**
- Option:
- 09 The lettering for the name of the person or entity being recognized may be composed of a combination of lower-case letters with initial upper-case letters.
- Guidance:*
- 10 *Freeways and expressways should not be signed as memorial or dedicated highways.*

Intentionally blank

CHAPTER 2N. EMERGENCY MANAGEMENT SIGNING

Section 2N.01 Emergency Management

Guidance:

- 01 *Contingency planning for an emergency evacuation should be considered by all State and local jurisdictions and should consider the use of all applicable roadways.*
- 02 *In the event of a disaster where highways that cannot be used will be closed, a successful contingency plan should account for the following elements: a controlled operation of certain designated highways, the establishment of traffic operations for the expediting of essential traffic, and the provision of emergency centers for civilian aid.*

Section 2N.02 Design of Emergency Management Signs

Standard:

- 01 **Emergency Management signs shall be used to guide and control highway traffic during an emergency.**
- 02 **Emergency Management signs shall not permanently displace any of the standard signs that are normally applicable.**
- 03 **Advance planning for transportation operations' emergencies shall be the responsibility of State and local authorities. The Federal Government shall provide guidance to the States as necessitated by changing circumstances.**
- 04 **Except as provided in Section 2A.11, the sizes for Emergency Management signs shall be as shown in Table 2N-1.**

Support:

- 05 Section 2A.11 contains information regarding the applicability of the various columns in Table 2N-1.

Option:

- 06 Signs larger than those shown in Table 2N-1 may be used (see Section 2A.11).

Guidance:

- 07 *As conditions permit, the Emergency Management signs should be replaced or augmented by standard signs.*
- 08 *The background of Emergency Management signs should be retroreflective.*
- 09 *Because Emergency Management signs might be needed in large numbers for temporary use during an emergency, consideration should be given to their fabrication from any light and economical material that can serve through the emergency period.*

Option:

- 10 Any Emergency Management sign that is used to mark an area that is contaminated by biological or chemical warfare agents or radioactive fallout may be accompanied by the standard symbol that is illustrated in the upper left corner of the EM-7c and EM-7d signs in Figure 2N-1.

Section 2N.03 Evacuation Route Signs (EM-1)

Standard:

- 01 **The Evacuation Route (EM-1) sign shall display a blue circular symbol on a white square sign without a border as shown in Figure 2N-1. The EM-1 sign shall include a white directional arrow (except as provided in Paragraph 3) and a white legend EVACUATION ROUTE within the blue circular symbol.**

Option:

- 02 Instead of including a directional arrow within the blue circular symbol on the EM-1 sign, an Advance Turn Arrow (M5 series) or Directional Arrow (M6 series) auxiliary sign as shown in Figure 2D-5, but with a white arrow on a blue background instead of a black arrow on a white background, may be installed below the EM-1 sign.

Table 2N-1. Emergency Management Sign Sizes¹

Sign or Plaque	Sign Designation	Section	Minimum Size
Evacuation Route	EM-1	2N.03	24 x 24 ²
AREA CLOSED	EM-2	2N.04	30 x 24
TRAFFIC CONTROL POINT	EM-3	2N.05	30 x 24
MAINTAIN TOP SAFE SPEED	EM-4	2N.06	24 x 30
Permit Required	EM-5	2N.07	24 x 30
Emergency Aid Center	EM-6a to EM-6d	2N.08	30 x 24
Shelter Directional	EM-7a to EM-7d	2N.09	30 x 24

Notes:

1. a.) Larger signs may be used when appropriate.
b.) Dimensions in inches are shown as width x height.
2. A minimum size of 18 x 18 may be used on low-volume roadways or roadways with speeds of 25 mph or less.

Figure 2N-1. Emergency Management Signs

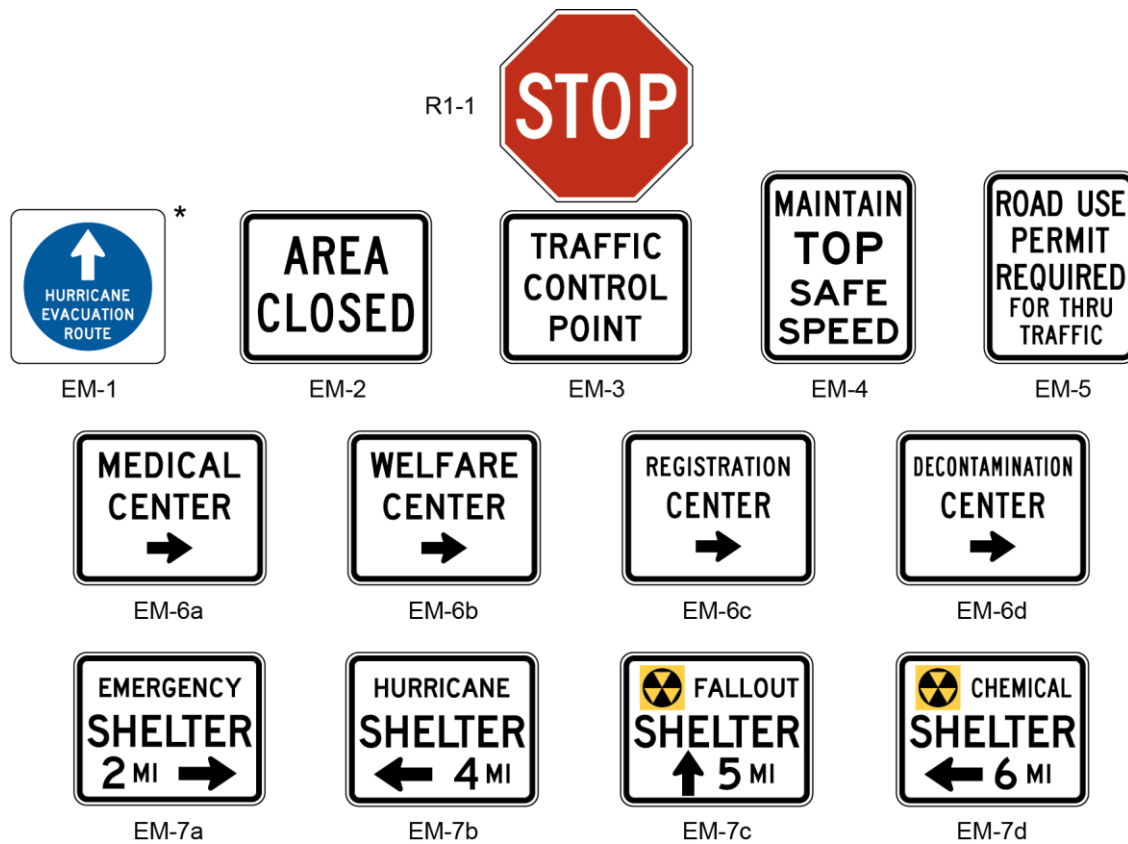

* HURRICANE is an example of one type of evacuation route. Legends for other types may also be used, or this line of text may be omitted.

03 If desired, the word HURRICANE, or a word that describes some other type of evacuation route, may be added as a third line of text above the white EVACUATION ROUTE legend within the blue circular symbol on the EM-1 sign.

04 An approved Emergency Management symbol with a diameter of 3.5 inches may appear near the bottom of an Evacuation Route sign.

Standard:

05 The arrow designs, if used, on the EM-1 sign shall include a straight, vertical arrow pointing upward, a straight horizontal arrow pointing to the left or right, or a bent arrow pointing to the left or right for advance warning of a turn.

06 If used, the Evacuation Route sign, with the appropriate arrow, shall be installed 150 to 300 feet in advance of, and at, any turn in an approved evacuation route. The sign shall also be installed elsewhere for straight-ahead confirmation where needed.

07 If used in urban areas, the Evacuation Route sign shall be mounted at the right-hand side of the roadway, not less than 7 feet above the top of the curb, and at least 1 foot back from the face of the curb. If used in rural areas, the Evacuation Route sign shall be mounted at the right-hand side of the roadway, not less than 7 feet above the pavement and not less than 6 feet or more than 10 feet to the right of the right-hand roadway edge.

08 Evacuation Route signs shall not be placed where they will conflict with other signs. Where conflict in placement would occur between the Evacuation Route sign and a standard regulatory sign, the regulatory sign shall take precedence.

Option:

09 In case of conflict with guide or warning signs, the Evacuation Route sign may take precedence.

Guidance:

10 *Placement of Evacuation Route signs should be made under the supervision of the officials having jurisdiction over the placement of other traffic signs. Coordination with Emergency Management authorities and agreement between contiguous political entities should occur to assure continuity of routes.*

Section 2N.04 AREA CLOSED Sign (EM-2)

Standard:

01 The AREA CLOSED (EM-2) sign (see Figure 2N-1) shall be used to close a roadway in order to prohibit traffic from entering the area. It shall be installed on the shoulder as near as practical to the right-hand edge of the roadway, or preferably, on a portable mounting or barricade partly or entirely in the roadway.

Guidance:

02 *For best visibility, particularly at night, the sign height should not exceed 4 feet measured vertically from the pavement to the bottom of the sign. Unless adequate advance warning signs are used, it should not be placed to create a complete and unavoidable blocked route. Where feasible, the sign should be located at an intersection that provides a detour route.*

Section 2N.05 TRAFFIC CONTROL POINT Sign (EM-3)

Standard:

01 The TRAFFIC CONTROL POINT (EM-3) sign (see Figure 2N-1) shall be used to designate a location where an official traffic control point has been set up to impose such controls as are necessary to limit congestion, expedite emergency traffic, exclude unauthorized vehicles, or protect the public.

02 The sign shall be installed in the same manner as the AREA CLOSED sign (see Section 2N.04), and at the point where traffic must stop to be checked.

03 The standard STOP (R1-1) sign shall be used in conjunction with the TRAFFIC CONTROL POINT sign. The TRAFFIC CONTROL POINT sign shall consist of a black legend and border on a retroreflectorized white background.

Guidance:

04 *The TRAFFIC CONTROL POINT sign should be mounted directly below the STOP sign.*

Section 2N.06 MAINTAIN TOP SAFE SPEED Sign (EM-4)**Option:**

01 The MAINTAIN TOP SAFE SPEED (EM-4) sign (see Figure 2N-1) may be used on highways where conditions are such that it is prudent to evacuate or traverse an area as quickly as possible.

02 Where an existing Speed Limit (R2-1) sign is in a suitable location, the MAINTAIN TOP SAFE SPEED sign may conveniently be mounted directly over the face of the speed limit sign that it supersedes.

Support:

03 Since any speed zoning would be impractical under such emergency conditions, no minimum speed limit can be prescribed by the MAINTAIN TOP SAFE SPEED sign in numerical terms. Where traffic is supervised by a traffic control point, official instructions will usually be given verbally, and the sign will serve as an occasional reminder of the urgent need for maintaining the proper speed.

Guidance:

04 *The sign should be installed as needed, in the same manner as other standard speed signs.*

Standard:

05 **If used in rural areas, the MAINTAIN TOP SAFE SPEED sign shall be mounted on the right-hand side of the road at a horizontal distance of not less than 6 feet or more than 10 feet from the roadway edge, and at a minimum height, measured vertically from the bottom of the sign to the elevation of the near edge of the traveled way, of 5 feet. If used in urban areas, the minimum height, measured vertically from the bottom of the sign to the top of the curb, or in the absence of curb, measured vertically from the bottom of the sign to the elevation of the near edge of the traveled way, shall be 7 feet, and the nearest edge of the sign shall be not less than 1 foot back from the face of the curb.**

Section 2N.07 ROAD (AREA) USE PERMIT REQUIRED FOR THRU TRAFFIC Sign (EM-5)**Support:**

01 The intent of the ROAD (AREA) USE PERMIT REQUIRED FOR THRU TRAFFIC (EM-5) sign (see Figure 2N-1) is to notify road users of the presence of the traffic control point so that those who do not have priority permits issued by designated authorities can take another route, or turn back, without making a needless trip and without adding to the screening load at the post. Local traffic, without permits, can proceed as far as the traffic control post.

Standard:

02 **If used, the ROAD (AREA) USE PERMIT REQUIRED FOR THRU TRAFFIC (EM-5) sign shall be used at an intersection that is an entrance to a route on which a traffic control point is located.**

03 **If used, the sign shall be installed in a manner similar to that of the MAINTAIN TOP SAFE SPEED sign (see Section 2N.06).**

Section 2N.08 Emergency Aid Center Signs (EM-6 Series)**Standard:**

01 **In the event of emergency, State and local authorities shall establish various centers for civilian relief, communication, medical service, and similar purposes. To guide the public to such centers a series of directional signs shall be used.**

02 **Emergency Aid Center (EM-6 series) signs (see Figure 2N-1) shall carry the designation of the center and an arrow indicating the direction to the center. They shall be installed as needed, at intersections and elsewhere, on the right-hand side of the roadway, in urban areas at a minimum height, measured vertically from the bottom of the sign to the top of the curb, or in the absence of curb, measured vertically from the bottom of the sign to the elevation of the near edge of the traveled way, of 7 feet, and not less than 1 foot back from the face of the curb, and in rural areas at a minimum height, measured vertically from the bottom of the sign to the elevation of the near edge of**

the traveled way, of 5 feet, and at a horizontal distance of not less than 6 feet or more than 10 feet from the roadway edge.

03 Emergency Aid Center signs shall carry one of the following legends, as appropriate, or others designating similar emergency facilities:

- A. MEDICAL CENTER (EM-6a),
- B. WELFARE CENTER (EM-6b),
- C. REGISTRATION CENTER (EM-6c), or
- D. DECONTAMINATION CENTER (EM-6d).

04 The Emergency Aid Center sign shall be a horizontal rectangle. Except as provided in Paragraph 5, the identifying word and the word CENTER, the directional arrow, and the border shall be black on a white background.

Option:

05 When Emergency Aid Center signs are used in an incident situation, such as during the aftermath of a nuclear or biological attack, the background color may be fluorescent pink (see Chapter 6I).

Section 2N.09 Shelter Directional Signs (EM-7 Series)

Standard:

01 Shelter Directional (EM-7 series) signs (see Figure 2N-1) shall be used to direct the public to selected shelters that have been licensed and marked for emergency use.

02 The installation of Shelter Directional signs shall comply with established signing standards. Where used, the signs shall not be installed in competition with other necessary highway guide, warning, and regulatory signs.

03 The Shelter Directional sign shall be a horizontal rectangle. Except as provided in Paragraph 4, the identifying word and the word SHELTER, the directional arrow, the distance to the shelter, and the border shall be black on a white background.

Option:

04 When Shelter Directional signs are used in an incident situation, such as during the aftermath of a nuclear or biological attack, the background color may be fluorescent pink (see Chapter 6I).

05 The distance to the shelter may be omitted from the sign when appropriate.

06 Shelter Directional signs may carry one of the following legends, or others designating similar emergency facilities:

- A. EMERGENCY (EM-7a),
- B. HURRICANE (EM-7b).
- C. FALLOUT (EM-7c), or
- D. CHEMICAL (EM-7d).

07 If appropriate, the name of the facility may be used.

08 The Shelter Directional signs may be installed on the Interstate Highway System or any other major highway system when it has been determined that a need exists for such signs as part of a State or local shelter plan.

09 The Shelter Directional signs may be used to identify different routes to a shelter to provide for rapid movement of large numbers of persons.

Guidance:

10 *The Shelter Directional sign should be used sparingly and only in conjunction with approved plans of State and local authorities.*

11 *The Shelter Directional sign should not be posted more than 5 miles from a shelter.*

Intentionally blank